



College of  
Respiratory Therapists  
of Ontario

# Optimizing Respiratory Therapy Services

A Continuum of Care from  
Hospital to Home

**A Training Manual for  
Paediatrics & Adults**

Healthcare Professionals and Caregivers

June 2010

## Project Team

Mary Bayliss  
Carole Hamp  
Dianne Johnson  
Rosanne Leddy  
Mika Nonoyama  
Christine Robinson  
Miriam Turnbull

## Partners



## Funding

Support for the development of this training manual was provided through HealthForceOntario's *Optimizing Use of Health Providers Competencies Fund*.



HealthForceOntario



College of  
Respiratory Therapists  
of Ontario

A copy of this Training Manual  
is available from

College of Respiratory Therapists of Ontario  
180 Dundas Street West, Suite 2103  
Toronto, Ontario M5G 1Z8  
Tel: 416-591-7800  
Fax: 416-591-7890  
Toll free: 1-800-261-0528  
Email: [questions@crto.on.ca](mailto:questions@crto.on.ca)  
Web site: [www.crto.on.ca](http://www.crto.on.ca)

## Acknowledgements

The College of Respiratory Therapists of Ontario (CRTO) gratefully acknowledges the Ministry of Health and Long Term Care's Health Force Ontario branch for funding this collaborative initiative entitled "Optimizing Respiratory Therapy Services: A Continuum of Care from Hospital to Home".

We would also like to thank the Toronto Central Local Health Integration Network (LHIN) for its support of this initiative.

We would like to recognize the participation of our partners in this initiative.

Central Community Care Access Centre  
Professional Respiratory Home Care Services  
Respiratory Therapy Society of Ontario  
West Park Healthcare Centre

We also acknowledge the valuable contribution of the following organizations in the development of this teaching package.

Hamilton Health Sciences  
Kingston General Hospital  
London Health Sciences Centre  
St Michael's Hospital, Toronto  
Sick Kids, Toronto  
The Ottawa Rehabilitation Centre  
Ventilator Equipment Pool, Kingston

We acknowledge the following Respiratory Therapists for their dedication and tireless commitment to this project.

Carlos Bautista	Gail Lang
Melva Bellefontaine	Adrienne Leach
Rob Bryan	Karen Martindale
Noreen Chan	Raymond Milton
Janet Fraser	Ginny Myles
Terri Haney	Patrick Nellis
Chris Harris	Margaret Oddi
Melissa Heletea	Regina Pizzuti
Dave Jones	Faiza Syed
Jeannie Kelso	Renata Vaughan

Special thanks to the ProResp Clinical Team.

Our thanks to all of the patients/clients, families and "hands on" caregivers without whom this project would not have succeeded.





College of  
Respiratory Therapists  
of Ontario

# Optimizing Respiratory Therapy Services

A Continuum of Care from  
Hospital to Home

**A Training Manual for  
Paediatrics & Adults**

Healthcare Professionals and Caregivers

June 2010

# Disclaimer

---

Information published by The College of Respiratory Therapists (CRTO) is provided for educational purposes only and is intended for Ontario residents.

**This educational material does not provide medical advice.** Information provided is not designed or intended to constitute medical advice or to be used for diagnosis of an individual patient's condition. Due to unique needs and medical history, patients are advised to consult their own healthcare professional(s) who will be able to determine the appropriateness of the information for their specific situation, and will assist them in making any decisions regarding treatment and/or medication.

**Specific products, processes or services.** Reference to, or mention of, specific products, processes or services does not constitute or imply a recommendation or endorsement by CRTO and/or its contributors.

**Links to other sites** are provided as a reference to assist you in identifying and locating other Internet resources that may be of interest. Please remember that Internet resources are no substitute for the advice of a qualified healthcare practitioner. We do not assume responsibility for the accuracy or appropriateness of the information contained in other sites, nor do we endorse the viewpoints expressed in other sites.

**Use of this educational material is encouraged, all we ask is that you give credit to the CRTO and this project\*.**

Should you identify any areas that require revisions or updates please let us know.

\* Support for the development of this training manual was provided through HealthForceOntario's *Optimizing Use of Health Providers Competencies Fund*. Please refer to the back cover of this educational package to view a complete list of the project partners.



## Section #1: Introduction & Glossary of Terms

- Introduction to Manual
- Introduction to the CD Resources
- Glossary of Terms

## Section #2: Healthcare Professionals

### Discharge Identification & Preparation

- 📖 Identification and Preparation Tool

### Discharge Checklists

- 📖 Preparation for ICU Discharge
- 📖 Preparation for Hospital Discharge

## Section #3: Patients/Clients & Caregivers

### Ventilation & Tracheostomy Care

- 📖 Home Ventilation & Tracheostomy Care (for Adults)
- 📖 Non-Invasive Positive Pressure Ventilation (for Adults)
- 📖 Home Ventilation & Tracheostomy Care (for Paediatrics)

### Pulmonary Clearance Techniques

- 📖 Pulmonary Clearance Techniques

### Education Checklists

- 📖 Routine Tasks
- 📖 My Education Checklist and Learning Log
- 📖 Oximeter Teaching Checklist

### Troubleshooting

- 📖 Troubleshooting Guide

### Emergency Contacts and Planning

- 📖 Emergency Contacts and Planning
- 📖 Useful Web Resources
- 📖 Emergency Preparedness Guide for People with Disabilities/Special Needs

## Section #4: Appendices

### Appendix A

- Assistive Devices Program
- Equipment/Supply Authorization Form (Sample)

### Appendix B

- Quick Reference Guide to LTV® 1200/1150 Series Ventilators

### Appendix C

- Quick Reference Guide to LTV® 900, 950 & 1000 Series Ventilators



## Section #1: Introduction & Glossary of Terms

Introduction to Manual  
Introduction to the CD Resources  
Glossary of Terms

## Section #2: Healthcare Professionals

### Discharge Identification & Preparation

 Identification and Preparation Tool

### Discharge Checklists

 Preparation for ICU Discharge

 Preparation for Hospital Discharge

## Section #3: Patients/Clients & Caregivers

### Ventilation & Tracheostomy Care

 Home Ventilation &  
Tracheostomy Care (for Adults)

 Non-Invasive Positive Pressure  
Ventilation (for Adults)

 Home Ventilation &  
Tracheostomy Care (for Paediatrics)

### Pulmonary Clearance Techniques

 Pulmonary Clearance Techniques

### Education Checklists

 Routine Tasks

 My Education Checklist and Learning Log

 Oximeter Teaching Checklist

### Troubleshooting

 Troubleshooting Guide

### Emergency Contacts and Planning

 Emergency Contacts and Planning

 Useful Web Resources

 Emergency Preparedness Guide for  
People with Disabilities/Special Needs

## Section #4: Appendices

### Appendix A

Assistive Devices Program  
Equipment/Supply Authorization Form (Sample)

### Appendix B

Quick Reference Guide to LTV® 1200/1150 Series Ventilators

### Appendix C

Quick Reference Guide to LTV® 900, 950 & 1000 Series Ventilators



# **Section #1: Introduction & Glossary of Terms**

Introduction to Manual

Introduction to the CD Resources

Glossary of Terms

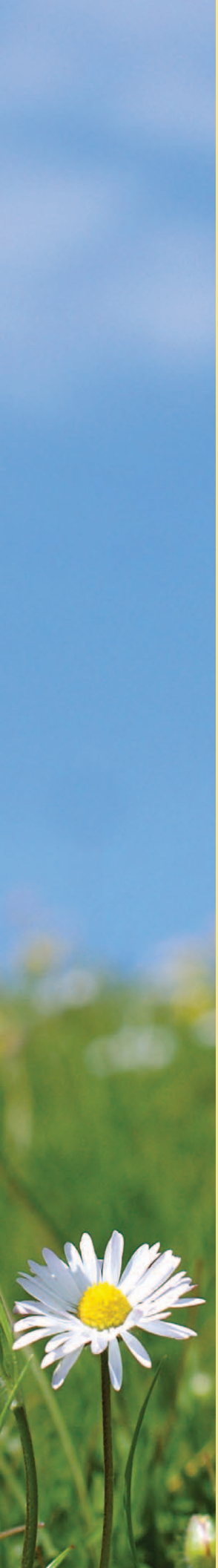



# Section #1: Introduction & Glossary of Terms

Introduction to Manual

Introduction to the CD Resources

Glossary of Terms



## Introduction to the Manual

Mechanical ventilation was first developed during the polio epidemic in the 1950s when patients were placed in an iron lung. Today we use positive pressure ventilation with an endotracheal tube or a tracheostomy tube. For the majority of patients, ventilation is usually short term and is discontinued after the respiratory or ventilatory failure has resolved. Most patients are weaned off the ventilator with no problems. However, for some patients weaning is a challenge.

If a patient cannot be weaned off the ventilator they are deemed 'ventilator-dependent'. Chronic ventilated patients can be found in acute-care hospitals, ventilator step-down units, long term care facilities, and at home. It is ideal and safe to transition stable, chronically ventilated patients to their homes.

A stable, ventilator dependent patient can be transitioned successfully from the ICU to home, or a long term care facility. This shift from acute care to home care has resulted in improved quality of life, decreased morbidity and mortality, and reduced care costs. Patients and families report that they are happier at home and have a better quality of life.

The intent of this document is to assist respiratory therapists and other healthcare providers to transition chronically ventilated individuals from hospital to the community. A successful hospital-to-home transition requires careful planning, and plenty of patient and family education. Prior to planning the transition, the patient must meet discharge criteria, such as being medically stable. These criteria can be found in this manual. For a smooth transition to occur, the patient needs a supportive family, caregivers and a medical team that communicates well. Once the ICU discharge criteria are met, the process of educating the patient and caregivers can begin. The *Education Checklist* and *Learning Log* will assist the educator and learner track the education process.

It is important to observe the caregivers participating in the care of the patient, while the patient is in the acute care setting. It is critical as a healthcare provider to document the learner's competency. A number of checklists have been provided in this manual to assist with this documentation requirement. All must be competent and comfortable prior to discharge.

The education process can take 2 - 4 weeks to complete, prior to a patient's discharge. To ensure the skills have been mastered, and to provide ongoing support, a comprehensive follow up plan is then continued within the community.

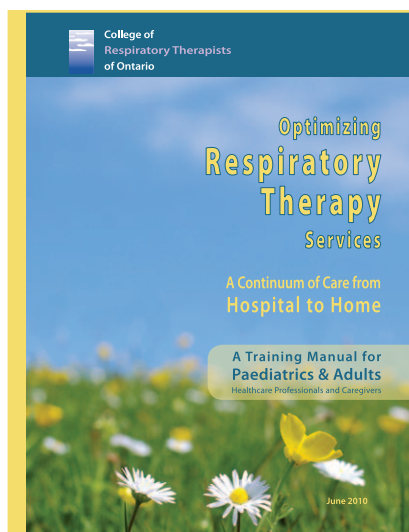

The material provided to the patient includes basic anatomy and physiology of the respiratory system, ventilator parameters, alarms, circuit changes, and backup power sources. Also covered are suctioning, stoma and tracheostomy care and how to respond in an emergency. This information is found in the *Home Ventilation & Tracheostomy Care* manuals.

There is also a *Troubleshooting Guide*, as an additional reference. For those patients on non-invasive ventilation refer to the *Non-Invasive Positive Pressure Ventilation* guide.

There are other tools and checklists to help you prepare the patient, their families and caregivers. The *Useful Web Resources* and *Glossary of Terms* can also be helpful. Team meetings need to take place, prior to and following discharge, between the acute care healthcare providers and the Community Care worker.

The intent of this document is to assist respiratory therapists and other healthcare providers to transition the chronically ventilated individual from the hospital to the community. If you have any suggestions or comments about this manual please forward them to The CRTO.



College of  
Respiratory Therapists  
of Ontario

180 Dundas Street West, Suite 2103  
Toronto, Ontario M5G 1Z8  
Tel: 416-591-7800  
Fax: 416-591-7890  
Toll free: 1-800-261-0528  
Email: [questions@crto.on.ca](mailto:questions@crto.on.ca)  
Web site: [www.crto.on.ca](http://www.crto.on.ca)

## Introduction to the CD

The CD, found in the inside back cover, contains all the information and worksheets that are presented here in this manual. The materials are sorted by 'tab' or topic and are ready for print. To view the files, you must have Adobe Reader software. To obtain Adobe Reader, visit, <http://get.adobe.com/uk/reader>.





## Glossary of Terms

---

The following is a list of words that you will find in the manual. Some of the terms are things you may hear your healthcare worker say. Always ask if you do not understand something.

### A

**Aerosol:** Solution that is given in a mist

**Apnea:** Not breathing

**Antibiotics:** Medicines that fight infections

**Artificial nose:** A device that warms and moistens the air

**Artificial airway:** A cut made in the trachea resulting in an opening that bypasses the nose and mouth. Also called “trach” or “tracheostomy”

**Aspiration:** Food or liquid breathed into the airway instead of swallowed

**Asthma:** Difficult breathing with wheezing that is caused by swelling or spasms of the airways

### B

**Bacteria:** Germs

**Bacterial:** Caused by bacteria

**Breathing bag:** Ventilating bag used for manual resuscitation

**Bronchi:** The two main branches leading from the trachea to the lungs

### C

**Cap:** A small cap used to plug the trach opening

**Cannula:** The tube part of the trach tube

**Carbon Dioxide (CO<sub>2</sub>):** Gas eliminated from the lungs with exhalation

**Cardiopulmonary resuscitation (CPR):**

Artificially supporting breathing and the circulation

**Carina:** The point of where the right and left bronchi separate

**Catheter:** A small tube placed inside the body to add or remove liquids

**CPAP:** A ventilation mode that helps a patient’s own breathing efforts. Stands for continuous positive airway pressure

**Cuff:** The inflatable balloon on some trach tubes

**Cyanosis:** A bluish color of the skin due to reduced oxygen in the blood

### D

**Decannulation:** Removal of the trach tube

**Diaphragm:** The big muscle below the lungs that controls breathing

**Dysphagia:** Difficulty swallowing

**Dyspnea:** Labored or difficulty breathing, shortness of breath

### E

**Edema:** Swelling of tissue.

**Encrustation:** Hard and dried mucus that can build up around the inner cannula.

**ENT:** It is a term used for type of doctor that specializes in the ‘ear nose throat’. ENT doctors do tracheotomy surgery

**ET tube (endotracheal tube):** A tube used to provide an airway through the mouth or nose into the trachea.

**Epiglottis:** “Trap door”. A piece of cartilage that hangs over the larynx like a lid and stops food, and liquids from going down into the lungs

**Esophagus:** The tube between the throat and the stomach

**Exhale:** To breathe out

**Extubation:** Removal of the endotracheal tube

**Expiration:** Breathing out of air from lungs

## F

**Fenestrated:** Having an opening in the trach tube to allow speech

**Fenestrated inner cannula:** An inner cannula with holes in it. This lets air go from the trach tube up to the mouth, and nose. The outer cannula must also have holes in it to work

**Fenestration:** A single hole or pattern of smaller holes

**Flange:** Part of the trach tube, also called the neck plate

## G

**Glottis:** The sound producing part of the larynx that consists of the vocal cords

## H

**Heat moisture exchanger (HME):** A filter device that fits into the end of the trach tube to warm and moisten the air the patient breathes

**Home healthcare professional:** Individual who gives care at home

**Home healthcare supplier:** Also called medical equipment supplier. They provide equipment, oxygen, trach care supplies.

**Humidity:** Moisture in the air

**Hydrogen peroxide (H<sub>2</sub>O<sub>2</sub>):** Mild cleaning agent

**Hypoventilation:** Reduced rate and depth of breathing

**Hypoxemia:** A low amount of oxygen in the blood

## I

**Inflation line:** The thin plastic line attached to trach tube balloon on one end and pilot balloon on the other. It is used to inflate and deflate the trach tube balloon (cuff).

**Inflation syringe:** A plastic syringe without needle used to inflate the trach tube balloon (cuff)

**Inhale:** To breathe in.

**Inner cannula:** The inner removable tube that fits inside the outer cannula. May be removed to clean or exchanged with different inner cannula.

**Inspiration:** To breathe in

**Intubation:** Placement of a tube into the trachea to help with breathing.

## L

**Larynx:** “Voice box” or “Adams apple”. Is just on top of the trachea.

**Lumen:** The inside of the trach tube through which air passes.

**M**

**Mucous:** Slippery fluid that is made in the lungs and windpipe

**Mm:** Short form for millimeter. One millimeter equals .039 inches

**N**

**Nebulizer:** A machine that puts moisture and or medicine into the airway and lungs

**Neck plate:** Part of the trach tube that sits against the neck, also called the flange

**Nosocomial infection:** An infection that you got during your hospital stay

**O**

**Obstruction:** Blockage

**Obturator:** The guide that goes in the trach tube to help insert the tube into the trachea

**Outer cannula:** The main tube with neck plate that is placed into the trachea

**Oximeter:** Equipment that monitors the amount of oxygen in the blood

**Oxygen:** A gas that the body needs to stay alive

**P**

**Patent:** Open, clear airway

**Pneumonia:** Swelling of the lung that is often caused by germs

**R**

**Respirologist:** A doctor who looks after the lungs

**Respite:** A break for caregivers who care for a disabled family member at home

**Retractions:** Pulling or jerky movement of the chest and neck muscles. It's a sign of respiratory distress

**S**

**Secretions:** Another word for mucous.

**Speaking valve:** A one way valve that lets air come into the trach tube when you breathe in. When you breathe out, the valve closes sending air out past the vocal cords and through the mouth so speech is possible.

**Speech language pathologist:** A person trained to help with speaking and swallowing problems

**Stoma:** The hole in the neck where you insert the trach tube

**Sterile:** Very clean and free from germs

**Suctioning:** One way to keep the inside of the trach tube clean and free of mucus. A small catheter is connected to a suction machine and placed into the trach tube to remove mucous

**Swivel neck plate:** A neck plate that can swivel up and down and/or side to side. Allows for greater range of head and neck movement without discomfort.

**Syringe:** Device to measure medicine

**T**

**Trach:** An opening into the trachea

**Trach mask:** A device that fits on the end of the trach tube to provide moisture

**Trachea:** "Windpipe". The tube through which air flows between the larynx and the lungs

**Tracheal wall:** The inside lining of the trachea

**Trach Tube:** A tubular device placed into the trach



**Trach Ties:** Cotton twill or Velcro tapes used to hold the trach tube in place. Connects to the slots in the trach tube neck plate

**V**

**Ventilator:** A machine that helps a person breathe

**Virus:** A germ that can cause illness

**Viscid:** Thick or sticky

**Vocal cords:** Two strips of tissue in the voice box in the neck, which allows vocalization

**W**

**Wheeze:** A whistling sound coming from the lungs because of a narrowing in the wind pipe or airways.

## Section #2: Healthcare Professionals

### Discharge Identification & Preparation

 Identification and Preparation Tool

### Discharge Checklists

 Preparation for ICU Discharge

 Preparation for Hospital Discharge



## Section #2: Healthcare Professionals

### Discharge Identification & Preparation

 Identification and Preparation Tool

### Discharge Checklists

 Preparation for ICU Discharge

 Preparation for Hospital Discharge



# Discharge Identification & Preparation

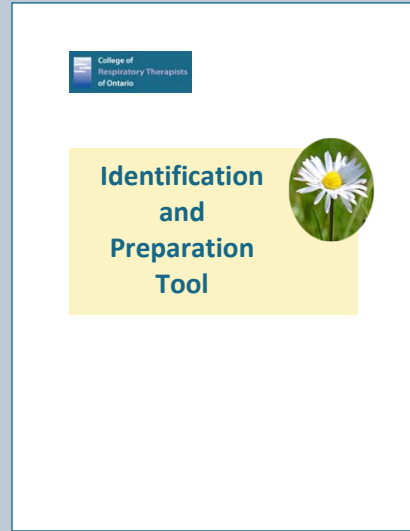







College of  
Respiratory Therapists  
of Ontario

# Identification and Preparation Tool





# Evaluation and Discharge Planning

---

## Discharge Assessment

The following is a high-level approach the interdisciplinary team can use during the preliminary stages of identifying a candidate for home or community placement.

### Assessment of the Home Environment

Assessment includes geographic location, available space, and accessibility.

- ✓ A home to go to
- ✓ Home environment prepared in advance to accommodate the patient's needs
- ✓ Adequate number of grounded electrical outlets
- ✓ Respiratory equipment supplier is aware of individual
- ✓ Sturdy bedside table for the ventilator placement

### Assessment of Caregivers

Caregivers must be motivated and able to learn the care routines.

- ✓ Patient is able and willing to supervise/direct care
- ✓ Individual is able and willing to participate in self care, or has sufficient caregiver assistance to adequately meet medical, respiratory, and personal care needs

### Education and Training

There is a comprehensive education plan with learning objectives and evaluation for individual, family and caregivers.

- ✓ Caregivers identified and trained prior to discharge (See *Home Ventilation & Tracheostomy Care, and Education Checklist and Learning Log* provided in this manual)
- ✓ Adequate nutrition program is in place
- ✓ Successful and stable trials: for at least two weeks prior to discharge with no changes
  - On home equipment ventilator prior to discharge, (e.g. ventilator, monitor, oxygen, if applicable)
  - Leaving the hospital setting with home caregivers

## Assessment of Resources

This includes professional services, support systems, individual's financial resources.

- ✓ Adequate financial resources and mechanisms for reimbursement identified prior to discharge
- ✓ Potential referrals in place: Respiriologist, Occupational Therapist, Physical Therapist, Social Worker, Registered Dietitian, Pharmacist, Community Care Access Centres (CCAC)
- ✓ Appropriate application forms completed:
  - Assistive Devices Program:
    - Tracheostomy
    - Ventilator
    - Enteral feeds, if applicable
  - Home Oxygen Program, if applicable
  - Special services at home
  - Handicapped parking permits
  - Wheelchair
- ✓ Contact the Ventilator Equipment Pool (VEP) to discuss the most appropriate equipment available and lead time for delivery

## Plan of Care

A written management plan for respiratory, medical care, and emergencies.

- ✓ Individual is medically stable: oxygen requirement less than, or equal to 40%; stable blood gases; mature tracheostomy and no events requiring CPR for at least one month
- ✓ Comprehensive discharge plan in place
- ✓ The treatment plan for all medical conditions is in place
  - Plan does not require frequent changes
  - Plan is transferable to the community
- ✓ Discharge planning meetings in place, including the individual, caregivers, healthcare team and community services

## Team Meetings

Initial team meetings are to take place while the ventilator-assisted individual (VAI) is in the hospital.

### First Team Meeting

Primary aims of this meeting are:

- ✓ Determine the short and long term goals
- ✓ Identify issues and potential barriers to discharge
- ✓ Create plans to manage issues and potential barriers to discharge
- ✓ Complete feasibility assessment of required community support
- ✓ Identify additional funding opportunities for the patient

Team members should include the individual, their caregivers and the inter-professional team:

- |  |                               |
|--|-------------------------------|
| ✓ Individual                           | ✓ Speech Language Pathologist |
| ✓ Family and caregivers                | ✓ Occupational Therapist (OT) |
| ✓ Most responsible physician           | ✓ Registered Dietitian (RD)   |
| ✓ Nurse (RN)                           | ✓ Pharmacist                  |
| ✓ Community Respiratory Therapist (RT) | ✓ CCAC Case Manager           |
| ✓ Social Worker (SW)                   | ✓ Discharge planner           |
| ✓ Physical Therapist (PT)              |                               |

### Second Team Meeting

Primary aims of this meeting are:

- ✓ Determine if discharge to home or community facility is achievable
- ✓ Prioritize goals and timelines; those to be achieved prior to discharge
- ✓ Determine a realistic discharge date
- ✓ Delineate roles and responsibilities for all team members, including the caregiver and family
  - Care plans
  - Funding applications
  - Discharge guidelines
  - Learning needs assessments
  - Education training programs
  - Equipment acquisition



Additional team members at this meeting should include the community care providers:

- ✓ Community RT
- ✓ Community PT
- ✓ Community OT
- ✓ Nursing agency provider

### **Follow up Meetings**

Primary aims of this meeting are:

- ✓ Monitor progress toward goals
- ✓ Update the patient and caregivers
- ✓ Identify other barriers to discharge and develop a resolution plan
- ✓ Communicate among the inter-professional disciplinary team

# Placement Considerations in the Home

---

## Adequate Daily Care Coverage

In addition to the care provided by the caregiver(s), the patient may receive additional care hours through CCAC. Access to immediate assistance is recommended for any individual who requires 24 hours ventilation or is fully dependent in their activities of daily living. This can be a trained community care provider, such as a Registered RT, Nurse, PSW or trained family member.

Individuals who live in Ontario who require suctioning or catheterization as part of their normal daily routine have a legislated exemption in the Regulated Health Professional Act (RHPA) allowing non-registered professionals to provide this service, provided they are competent to do so.

## Additional Considerations

### Mobility

A VAI may require a wheelchair with ventilator and oxygen carrying capacity. The vehicle used for mobility **must** be able to safely carry a ventilator and external battery without tipping. Home ventilators can weigh up to 35 lbs. Ventilator shelves can be attached to some standard wheelchairs, but some of these chairs may not be wide enough or balanced enough to hold the additional weight. Often a VAI has their own wheelchair that can be adapted by the supplier to carry the ventilator and battery. If this is not possible, an application for a customized wheelchair with ventilator carrying capability can be made.

Assessment and applications are usually made by the OT or PT and signed by the physician. The chair supplier will need the ventilator and battery dimensions. Information that can be obtained from the RT.

Other mobility devices may be required, such as ambulation aids and positioning devices (lifts).

Applying early in the process will reduce delays. Check with the equipment provider for the anticipated delivery date.

## Equipment Acquisition

The Ministry of Health and Long-Term Care (MOHLTC) funds 75% of the cost of respiratory supplies through the Assisted Devices Program (ADP). **The remaining 25% is the responsibility of the individual.**

Contact the VEP or alternate provider for details on equipment acquisition. Note: some individuals are not eligible for equipment through the VEP. For example, patients discharged to long term care facilities do not have access to VEP equipment. See VEP website for more information on eligibility <http://www.ontvep.ca>.

## Home Mechanical Ventilators

A VAI discharged to the community is provided with:

- ✓ Ventilator(s)
- ✓ Battery charger
- ✓ Heated humidifier
- ✓ External battery for emergency power only
- ✓ Battery cable
- ✓ Re-useable ventilator circuits

The cost of **this** equipment is 100% covered by the MOHLTC, through ADP. Applications must be signed by the physician.

The VAI should have completed several successful trials on a home mechanical ventilator, before setting them up for indefinite use.

## Other Respiratory Supplies

Requests are made by the home respiratory care service, to the ADP. This equipment may include:

- ✓ Apnea cardiorespiratory monitors
- ✓ Compressors for aerosolized medication delivery
- ✓ Postural drainage boards
- ✓ Suction machines
- ✓ Tracheostomy supplies
- ✓ Percussors
- ✓ Resuscitators
- ✓ Positive airway pressure systems

75% of the cost of **this** equipment may be covered by the MOHLTC. **The remaining 25% is the responsibility of the individual.**

Some equipment, although necessary for some VAIs, may not be funded through ADP. The following equipment is **not** funded:

- cough-assist devices
- oximeters for individuals 18 years or older
- 12 volt batteries for mobility purposes

### Other Medical Supplies

Other medical supplies may be necessary in the community setting and eligible for ADP funding e.g. enteral feed equipment. Check with the interprofessional healthcare team for details.

### Individual, Home Care Providers and Family Education

A successful discharge requires a simplified and comprehensive transfer of care routines from healthcare team to the community provider team. Ideally the community team would receive the transfer of skills within the acute care facility. This allows them to be in direct contact with the individual and work closely with the acute care team. This training technique serves to increase the confidence and comfort of both the community care providers, the individual and the caregivers.

Information provided in respiratory teaching packages typically should cover:

- ✓ Tracheostomy and ventilator care
- ✓ Individual-specific training checklist that must be completed prior to discharge; can also be used as a scheduling guide
- ✓ Emergency guidelines that are provided to address common problems that may arise within the home environment

### Respiratory Education

The training should include, but is not limited to:

- |   |                                      |
|---|--------------------------------------|
| ✓ Respiratory anatomy and physiology                  | ✓ Use of the manual resuscitator bag |
| ✓ Hands-on training with tracheal suctioning          | ✓ Switching to ventilator battery    |
| ✓ Ventilator troubleshooting and maintenance          | ✓ Charging the ventilator battery    |
| ✓ Tracheostomy tube cuff care; changing if applicable | ✓ Circuit assembly                   |
|   | ✓ Emergency planning                 |
|   | ✓ Cleaning of equipment              |
|   | ✓ Volume augmentation manoeuvres     |

## Emergency Plan and Recommended Physician Coverage

Emergency guidelines are provided to address common problems that may arise within the home environment. These guidelines are provided for each individual and placement situation. Included are: what should be done; who should do it; what services should be called, etc.

The individual's wishes regarding resuscitative efforts should be addressed and be available in the home for emergency response personnel.

The individual must have:

- ✓ A Family Physician who will manage day to day general medical needs
- ✓ A Respiriologist or other consultant who has expertise in mechanical ventilation, to manage ventilation needs
- ✓ A “home-base” hospital location should an emergency occur that cannot be solved at home. Ideally this is the acute-care facility discharging the individual home

For those caregivers wishing for Cardiopulmonary Resuscitation (CPR) certification, discuss this training with your healthcare provider.

Guidelines are provided that include contact numbers of home care providers and support services.

## Communication and Transfer of Information to Community Providers

With the individual’s consent, the discharge team should ensure the community care partners receive information on:

- ✓ Medical history
- ✓ Written consent
- ✓ Care plan, preferences, daily routines, typical patterns where interventions are required
- ✓ Transfer and discharge notes from the discharging physician
- ✓ Emergency guidelines
- ✓ Equipment and supplies list



## References

---

Dyson, J., Vrlak, A., & Provincial Respiratory Outreach Program (PROP). (2004). *Provincial Respiratory Outreach Program discharge planning guide* (User Guide). Vancouver: BC Association for Individualized Technology and Supports for People with Disabilities (BCITS).

Long-term Ventilated Patient Transfer Working Group. (2007). *Preparation of an ICU patient for transfer to LTV Unit*. Toronto: Toronto Central Local Health Integration Network.

Make, B., Hill, N., Goldberg, A., Bach, J., Criner, G., Dunne, P., et al. (1998). *Mechanical ventilation beyond the intensive care unit. Quick reference guide for clinicians. Highlights of patient management*.

Make, B., Hill, N., Goldberg, A., Bach, J., Criner, G., Dunne, P., et al. (1998). Mechanical ventilation beyond the intensive care unit. Report of a consensus conference of the American College of Chest Physicians. *Chest*, 113(5 Suppl), 289S-344S.

Montgomery, J. (2006). *An aid for identification and considerations for community placement of the long term ventilator dependent person*. London: Respiratory Community care, London Health Sciences Centre.



# Discharge Checklists

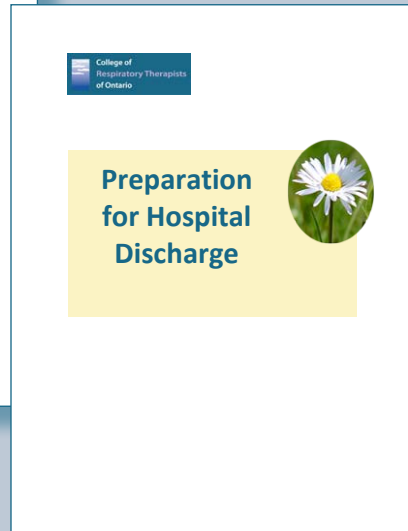
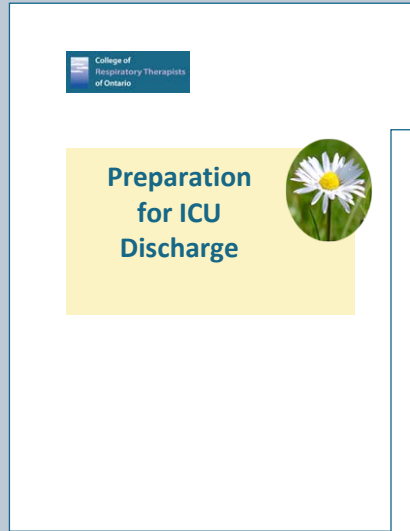





College of  
Respiratory Therapists  
of Ontario

# Preparation for ICU Discharge





# Decrease Invasive Monitoring

---

## Lines

- ✓ Remove arterial line
- ✓ Remove Nasogastric tube (NG tube), and other invasive lines/tubes
- ✓ If patient cannot have oral intake, switch NG tube to Gastrostomy tube (G-tube) or a Jejunostomy tube (J-tube)
- ✓ Cap Peripherally Inserted Central Catheter (PICC) lines if possible

## Blood Work

- ✓ Reduce blood work frequency

## Ventilation and Oxygenation

- ✓ Reduce to lowest FiO<sub>2</sub> to maintain SpO<sub>2</sub> 88-92%, and lowest PEEP (if at all required)
- ✓ Avoid using continuous pulse oximetry once Arterial Blood Gases (ABG) and oximetry have determined oxygen requirements. Use for periodic assessments of SpO<sub>2</sub>
- ✓ If available, switch the patient from a critical care ventilator to one that would be used in the home/community setting



# Treatment Plan

---

## Ventilation & Weaning

- ✓ If weaning is an option, consult/refer to Toronto East General Weaning Centre of Excellence
- ✓ Have ICU staff and allied healthcare professionals refrain from using the word “weaning” Instead, encourage staff to use the phrase “ventilator free time”
- ✓ Encourage the patient to increase their ‘ventilator free time’, even if it is in small increments. In the event of an accidental disconnect from the ventilator at home, the longer the ventilator free time, the safer. This also reduces caregiver anxiety
- ✓ For mechanical ventilation, use the simplest settings. Use assist control mode whenever possible since it is the most widely used ‘invasive’ mode. Most home ventilators do not have a pressure support option. However, one can petition the Ministry of Health for a ventilator with pressure support, if this is the only approach to ventilate

## Tracheostomy Tube

Select a tracheostomy tube that is most appropriate for the patient’s comfort and goals. The most desirable features for the new tracheostomy tube are:

- ✓ Cuffless or ‘Tight to Shaft’ Cuff: This decreases secretions caused from irritation of the cuff, increases potential for speech and increases sense of smell and taste
- ✓ Nonfenestrated Limitations: Tends to cause granulomatous tissue in the airway
- ✓ Reusable Inner Cannula: To decrease the frequency of suctioning, teach the patient to cough to the inner cannula and keep it clear
- ✓ Other tracheostomy tube models or characteristics are fully acceptable, if the above choices are not suitable
- ✓ Changing the tracheostomy tube to one of these desirable tubes is not a necessity before transferring out of the ICU, but will ease the transition
- ✓ If the caregivers in the community or the long-term care facility do not have access to or experience with alternative tracheostomy tubes, it would be best for the patient to wait before transitioning home
- ✓ If a specialty tracheostomy tube is selected, ensure that the caregivers or the long-term care facility knows how to reorder the speciality tubes
- ✓ Assess the patient for the ability to communicate/speak while ventilated
  - cuff deflation
  - cuffless tube
  - speaking valve/one way valve usage

- ✓ Ensure that the patient is well rested and there are no nutritional deficiencies
- ✓ Consider a swallowing study by a Speech-Language Pathologist, if not already completed

## Increase Independence

- ✓ Discuss differences between ICU care and care in the home/community or long-term care facility e.g.:
  - Expectation that patient will dress daily
  - Radically reduced “patient/staff” ratio
  - Increased independence
- ✓ Educate and train patient/family/caregivers on manual resuscitation bagging and suctioning techniques (these will be reinforced in the community)
- ✓ Move the patient to an area of the ICU with less activity, if possible
- ✓ Step down nursing complement. Consider the patient to nurse ratio
- ✓ Encourage use of a call bell, if able
- ✓ Dress the patient in his/her own clothes
- ✓ Encourage the patient to move to an upright chair as often as possible
- ✓ Have Occupational Therapy (OT) assess and begin process for obtaining equipment necessary for mobility and increased independence
- ✓ Consider taking the patient out of ICU for short periods of time, i.e. with staff and/or family
- ✓ Establish a routine bowel/bladder plan of care – regular day/night routine
- ✓ If going to a long-term care facility have someone from the receiving facility speak with family/caregivers about the program and take a tour of the facility

## Other

- ✓ Co-payment charges should be discussed with the family
- ✓ Possible equipment and service charges such as TV, telephone, chiropody, hairdressing





College of  
Respiratory Therapists  
of Ontario

# Preparation for Hospital Discharge





# Hospital Discharge Checklist

	Tasks	Initials of HCP	Date Completed
<b>Patient/client is Medically Stable</b>	<input type="checkbox"/> Stable blood gases		
	<input type="checkbox"/> Oxygen less than, or equal to 40%		
	<input type="checkbox"/> Established tracheostomy		
	<input type="checkbox"/> No CPR required for at least one month		
<b>Successful Trial on Home Equipment</b>	<input type="checkbox"/> Plan for family/caregivers to do more independent care		
	<input type="checkbox"/> Home ventilator obtained		
	<input type="checkbox"/> Patient/Client set-up on home unit		
	<input type="checkbox"/> Hospital walks, off unit		
	<input type="checkbox"/> Trial car ride		
	<input type="checkbox"/> Car seat test, if applicable		
	<input type="checkbox"/> Monitors		
	<input type="checkbox"/> Oxygen		
<b>Decrease Invasive Monitoring</b>	<input type="checkbox"/> Feeding pump		
	<input type="checkbox"/> Remove any invasive lines		
	<input type="checkbox"/> Ensure education for lines that will remain in place at home		
	<input type="checkbox"/> Ensure feeding is established <ul style="list-style-type: none"> <li>- NG tube</li> <li>- G-tube</li> <li>- J-Tube</li> <li>- oral</li> </ul>		
	<input type="checkbox"/> Reduce blood work frequency		
	<input type="checkbox"/> Switch over to home ventilator		
	<input type="checkbox"/> Ensure patient is weaned on current settings		
	<input type="checkbox"/> Self inflating resuscitation bag to be with patients at all times		
<b>Treatment Plan</b>	<input type="checkbox"/> Use simplest ventilation settings, if possible		
	<input type="checkbox"/> Use a trach tube that is appropriate for the patient's comfort/goals		
	<input type="checkbox"/> Ensure schedule is established for other therapies		

	Tasks	Initials of HCP	Date Completed
	<input type="checkbox"/> Suctioning		
	<input type="checkbox"/> Tracheostomy mask		
	<input type="checkbox"/> Breath stacking		
	<input type="checkbox"/> In-Exsufflator		
	<input type="checkbox"/> Speaking valve		
	<input type="checkbox"/> Other: _____		
<b>Caregiver and Family Education</b>	<input type="checkbox"/> Caregiver education is complete (See <i>My Education Checklist and Learning Log</i> )		
	<input type="checkbox"/> Plan for caregivers to do more independent care (including walks off the unit and trial car rides)		
	<input type="checkbox"/> CPR Certification		
	<input type="checkbox"/> Care by parent completed (at least 24 hours unassisted) using own home equipment.		
	<input type="checkbox"/> Tour of ICU/NICU Education of community caregivers (including Daycare or School).		
	<input type="checkbox"/> Family/Caregiver visit to current home ventilated patient		
	<input type="checkbox"/> Ensure the home care company has provided all the necessary equipment and training in the use of equipment provided to the family, i.e. compressor, cardiorespiratory monitor, suction unit and their accessories		
<b>Documents</b>	<input type="checkbox"/> Discuss ADP funding		
	<input type="checkbox"/> Complete ADP applications (contact ADP if help is required)		
	<input type="checkbox"/> Equipment from the Ventilator Equipment Pool; Ventilators, Oximeters, Bilevel devices. Contact VEP for estimated delivery time; often takes 2-4 weeks		
	<input type="checkbox"/> For other related respiratory supplies, contact the vendor of client's choice		
	<input type="checkbox"/> Complete Assistance for Children with Severe Disability (ACSD) application with physician letter, if appropriate		
	<input type="checkbox"/> Complete HOP form with qualifying oximetry strip, if appropriate		





	Tasks	Initials of HCP	Date Completed
	<input type="checkbox"/> Insurance contacted		
	<input type="checkbox"/> Contact Ontario Disability Support Program (ODSP) or other funding agency for battery to be mounted on wheelchair, if appropriate		
	<input type="checkbox"/> Family to contact private insurance, if appropriate		
	<input type="checkbox"/> Social worker to assist in securing additional funds		
	<input type="checkbox"/> Phone contact list for family/caregivers		
	<input type="checkbox"/> "Who to call and when" list to family/caregivers		
	<input type="checkbox"/> Ensure family/caregivers have teaching material, manuals needed		
	<input type="checkbox"/> Letters given to family to provide to police, ambulance, hydro, and telephone facilities (to alert community providers)		
	<input type="checkbox"/> Application for Accessible Parking Permit		
	<input type="checkbox"/> Discharge summary		
	<input type="checkbox"/> Rehab reports and referrals; including respite care		
	<input type="checkbox"/> Prescriptions provided and medications ordered		
<b>Equipment Needs</b>	<input type="checkbox"/> Confirm delivery date of equipment		
	<input type="checkbox"/> Car seat test done		
	<input type="checkbox"/> Specialty seating and mobility devices set up		
	<input type="checkbox"/> Equipment set up on wheelchair or stroller		
	<input type="checkbox"/> For patients that are off their ventilators for short periods or all day, a trach hood and appropriate humidity set ups are also required		
	<input type="checkbox"/> Contact OT for assistance in mounting ventilator on wheelchair		
<b>Follow-up</b>	<input type="checkbox"/> Community paediatrician identified and patient summary delivered		
	<input type="checkbox"/> Follow-up appointments made		

	Tasks	Initials of HCP	Date Completed
<b>Home and Community</b>	<input type="checkbox"/> Home ready including electrical needs		
	<input type="checkbox"/> Emergency action plan has been devised		
	<input type="checkbox"/> Enhanced respite funding (CCAC)		
	<input type="checkbox"/> Letter to police, fire, ambulance, hydro, and telephone facilities		
	<input type="checkbox"/> Arrangements made with pharmacy		
	<input type="checkbox"/> Calendar of appointments		
	<input type="checkbox"/> Contact List: "Who to call and when" list to family/caregiver		

Healthcare Provider (HCP) Name/Designation	Signature	Initials

## Section #3: Patients/Clients & Caregivers



### Ventilation & Tracheostomy Care

-  Home Ventilation & Tracheostomy Care (for Adults)
-  Non-Invasive Positive Pressure Ventilation (for Adults)
-  Home Ventilation & Tracheostomy Care (for Pediatrics)

### Pulmonary Clearance Techniques

-  Pulmonary Clearance Techniques

### Education Checklists

-  Routine Tasks
-  My Education Checklist and Learning Log
-  Oximeter Teaching Checklist

### Troubleshooting

-  Troubleshooting Guide

### Emergency Contacts & Planning

-  Emergency Contacts and Planning
-  Useful Web Resources
-  Acknowledgement of Source
-  Emergency Preparedness Guide for People with Disabilities/Special Needs



## Section #3: Patients/Clients & Caregivers

### Ventilation & Tracheostomy Care

- 📖 Home Ventilation & Tracheostomy Care (for Adults)
- 📖 Non-Invasive Positive Pressure Ventilation (for Adults)
- 📖 Home Ventilation & Tracheostomy Care (for Pediatrics)

### Pulmonary Clearance Techniques

- 📖 Pulmonary Clearance Techniques

### Education Checklists

- 📖 Routine Tasks
- 📖 My Education Checklist and Learning Log
- 📖 Oximeter Teaching Checklist

### Troubleshooting

- 📖 Troubleshooting Guide

### Emergency Contacts & Planning

- 📖 Emergency Contacts and Planning
- 📖 Useful Web Resources
- 📖 Acknowledgement of Source
- 📖 Emergency Preparedness Guide for People with Disabilities/Special Needs



# Ventilation & Tracheostomy Care

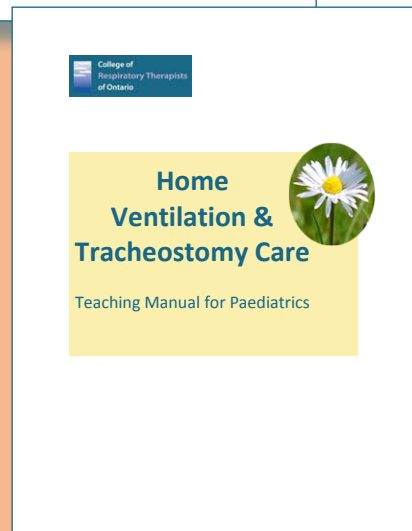
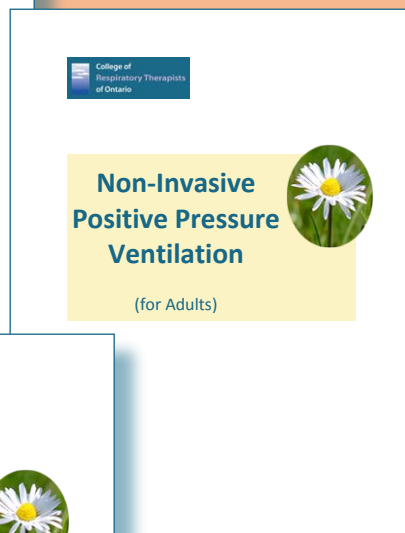
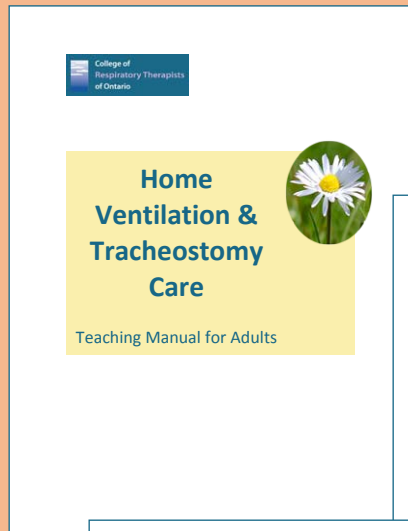





College of  
Respiratory Therapists  
of Ontario

# Home Ventilation & Tracheostomy Care



Teaching Manual for Adults





# Table of Contents

---

<b>Introduction</b> .....	<b>1</b>
<b>The Normal Respiratory System</b> .....	<b>2</b>
What Happens When I Breathe? .....	6
<b>Preventing Infection</b> .....	<b>7</b>
What can I do to Prevent Infections? .....	7
What is Pneumonia? .....	8
What are the signs of an infection? .....	8
What should I do if I have an infection? .....	8
Washing Your Hands at Home .....	9
Sterilizing Distilled Water.....	10
<b>Tracheostomy Care</b> .....	<b>11</b>
What is a Tracheostomy?.....	11
How do I Prepare to go Home With a Tracheostomy? .....	12
Where should I do my trach care?.....	13
Description of Tracheostomy (Trach) Tubes.....	14
Types of Trach Tubes .....	17
How do I know when I should replace my trach tube? .....	19
Stoma Care.....	20
Trach Tube Care .....	22
Other Information About Trach Tubes .....	26
Speaking Valves.....	29
Trach Kit .....	32
Special Considerations .....	29
Tracheal Suctioning.....	33
Other Helpful Tips .....	37
Changing the Trach Tube .....	38

<b>Mechanical Ventilation .....</b>	<b>41</b>
What is Mechanical Ventilation? .....	41
Why is Mechanical Ventilation Needed? .....	41
Ventilator Settings .....	42
Modes of Ventilation .....	42
Ventilator Rate .....	43
Ventilator Power Sources .....	45
The Ventilator Circuit .....	50
Ventilator Safety and Trouble Shooting.....	54
<b>Other Equipment .....</b>	<b>57</b>
Using and Cleaning the Portable Suction Unit.....	57
The Manual Resuscitation Bag.....	59
Humidifiers.....	63
Inhaled Medicine .....	68
<b>Other Issues.....</b>	<b>69</b>
Assistive Devices Program (ADP) Funding for Respiratory Supplies.....	69
The Ventilator Equipment Pool.....	71
<b>References .....</b>	<b>73</b>

## Introduction

---

This Manual has been written to help you learn how to care for your ventilator and tracheostomy. It will provide instructions on the basic care of a tracheostomy tube and will be yours to keep as a reference guide. This Manual will give you some instruction on how to suction, change the trach ties, change the trach tube, and some general safety guidelines. This book is only a guide. If you have any questions, ask any of your healthcare professionals.

**Important terms are used in this manual. Please refer to the Glossary of Terms for a complete list of definitions. A Troubleshooting section is also available.**

## The Normal Respiratory System

The respiratory system is made up of the:

### Upper Respiratory Tract

- ✓ Nose
- ✓ Mouth
- ✓ Larynx (voice box)

### Lower Respiratory Tract

- ✓ Trachea (windpipe)
- ✓ Right and Left Lung
- ✓ Airways (bronchi)
- ✓ Alveoli (air sacs)
- ✓ Capillaries

### Respiratory Muscles

- ✓ Diaphragm (largest muscle)
- ✓ Intercostals (rib cage muscles)
- ✓ Abdominal Muscles

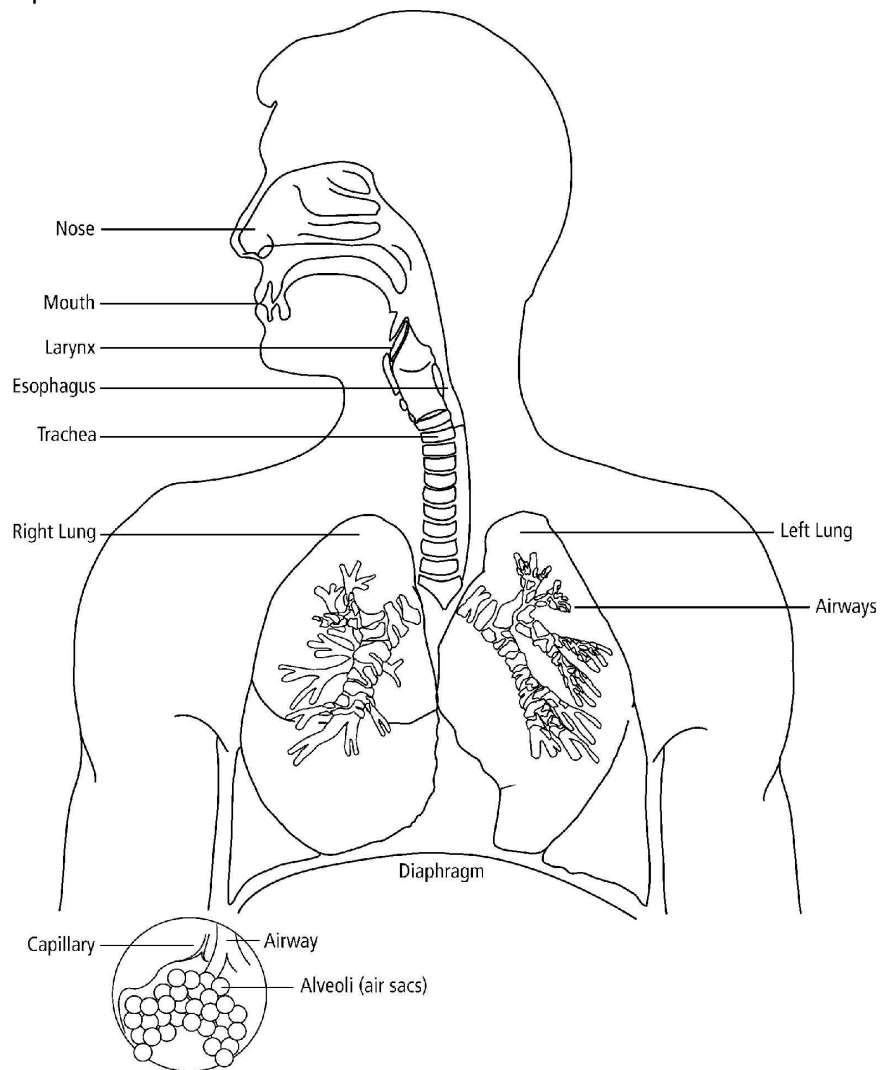

**Figure 1: Respiratory System**

Illustration used with permission from Hamilton Health Sciences

The **nose** is the best way for outside air to enter the lungs. In the nose the air is cleaned, warmed and moistened. There are hairs lining the inside of the nose that filter the air.

When you breathe through your **mouth** you are not filtering the air, but it will be warm and moist. When you have a cold and your nose is blocked you may not be able to breathe through your nose.

The **larynx** (voice box) contains the vocal cords. This is the place where air, when breathed in and out, creates voice sounds. It is also used to build up pressure for a strong cough.



**Figure 2: Larynx**

Reproduced with permission from Ottawa Rehabilitation Centre

The **epiglottis** is a flap of tissue that hangs over the larynx (voice box). When you swallow food or drink this flap covers the voice box and windpipe so you do not choke.

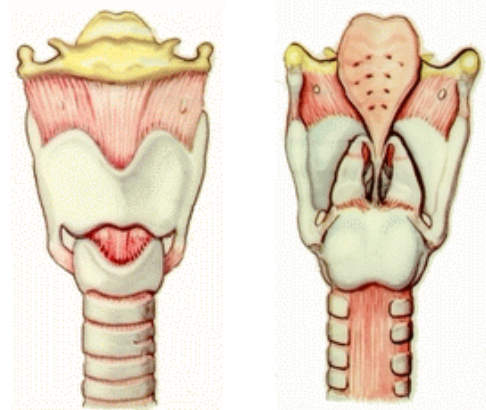

**Figures 3 & 4: Epiglottis**

Reproduced with permission from Ottawa Rehabilitation Centre

The **trachea** (wind pipe) is the tube leading from the voice box to the lungs.

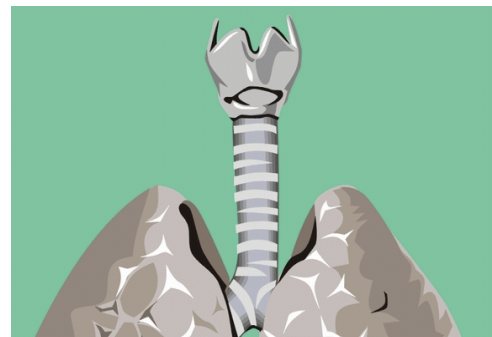

**Figure 5: Trachea**

Reproduced with permission from Ottawa Rehabilitation Centre

The **bronchi** are tubes that let air in and out of the lungs. The bronchi lead to tiny air sacs called the **alveoli**.

**Mucous** is made in the smaller tubes. The mucous traps dust, germs and other unwanted matter that has been breathed into the lungs.

Tiny hairs called **cilia** move back and forth moving the mucous up toward the throat where it can be coughed out or swallowed.

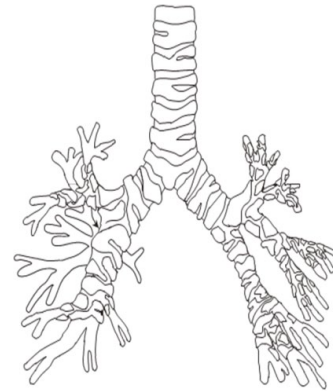

**Figure 6: Bronchi**

Reproduced with permission from Ottawa Rehabilitation Centre

The **capillaries** are blood vessels that are in the walls of the alveoli (air sacs). Blood flows through the capillaries, removing carbon dioxide from the air sacs and picking up oxygen.

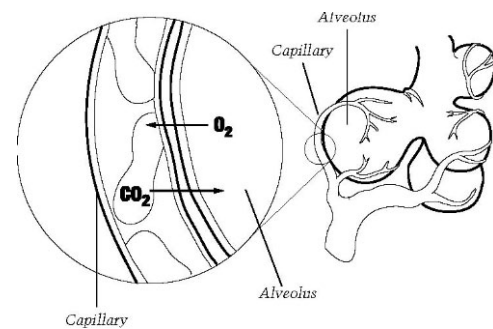

**Figure 7: Capillaries and Air Sac**

Diagram courtesy of SIMS Portex Inc Tracheostomy Care Handbook 1998

The **ribs** are bones that support and protect the chest cavity. They move up and out, helping the lungs expand and contract.

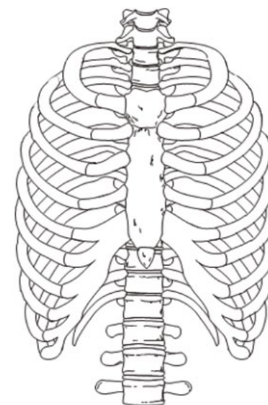

**Figure 8: Rib Cage**

Reproduced with permission from Ottawa Rehabilitation Centre

The **diaphragm** is a large strong muscle that separates the lungs from the belly. When the diaphragm contracts it moves downward, creating a suction effect, drawing air into the lungs.

The **intercostals** are the muscles in-between the ribs. There are two types of intercostals muscles.

The **external intercostals** help you take deep breaths in, such as when you prepare to cough.

The **internal intercostals** help you forcefully breathe out, such as when you cough or sneeze.

The **abdominal muscles** help create a good strong cough.

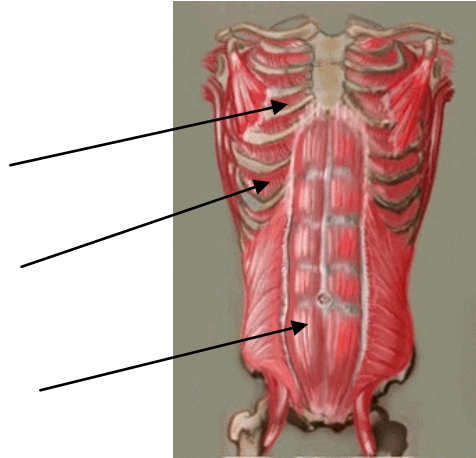

**Figure 9: Intercostal and Abdominal Muscles**

Reproduced with permission from Ottawa Rehabilitation Centre



## What Happens When I Breathe?

### Breathing In

When you breathe in a large muscle called the diaphragm contracts causing air to be sucked into the lungs. The air that is carried into the lungs contains oxygen that your body needs to survive.

When you breathe in, the diaphragm moves down and the ribs move out and up. This causes a suction effect that lets air come into the lungs. The air comes into the nose where it is warmed, filtered and moistened. The air then goes down the windpipe past the voice box. From there it moves into two large main branches of the lungs called the left and right bronchi. The air moves through airways that get smaller and smaller until they reach tiny air sacs. These air sacs let oxygen into the capillaries. The blood flows from these capillaries to the heart where it is pumped out to the body.

### Breathing Out

When you breathe out the lungs remove carbon dioxide, a gas that your body does not need.

Just before you begin to breathe out the carbon dioxide goes across from the capillaries into the air sacs. The air sacs begin to relax and the air begins to move out of the lungs. Then the diaphragm and the muscles between the ribs also relax. This causes the ribs to gently fall, helping to push the air out from the lungs. Under normal conditions, the diaphragm and rib cage muscles are relaxed when you breathe out. However, when you cough or sneeze, these muscles work hard to push the air out quickly.

Normally breathing takes place without any thought. Some conditions can cause breathing problems. Every condition is different. So talk to your healthcare professionals about how your condition affects your breathing.

# Preventing Infection

---

## What can I do to Prevent Infections?

Keep Things Clean!

### Hands

- ✓ Insist that everyone wash their hands, often
- ✓ Buy hand sanitizers for your home

### Air

- ✓ Make your home smoke free. Insist that no one smoke around you
- ✓ Tell friends and family to stay away if they have a cold or the flu. If they need to be near you they **must** wear a mask and wash their hands often

### Trach

- ✓ Follow trach care instructions carefully. Clean trach tubes
- ✓ Keep the trach dressings and the stoma (opening) clean and dry

### Equipment

- ✓ Clean equipment regularly, such as ventilator tubing and suction equipment
- ✓ Replace equipment on a regular schedule. Ask your healthcare professional when supplies are to be thrown out

---

**IMPORTANT! It is very important that *everyone* wash their hands. Wash your hands before and after doing anything with the trach tube or the stoma.**

---

## What is Pneumonia?

It is important to protect the lung from viruses and germs. If the air you breathe is clean and moist, it will stop an infection from happening.

Breathing in dry, dirty air can cause germs and viruses to get into the lung, which can lead to pneumonia. Pneumonia is a lung infection where the airways swell and more mucous than normal, is made. Pneumonia can lower the amount of air getting into the lungs. It can also lower the amount of oxygen getting into the blood.

---

**IMPORTANT! Wash your hands before and after doing anything with the tracheostomy.**

---

## What are the signs of an infection?

If you have any of these signs, it may mean you have an infection.

You are:

- ✓ coughing more
- ✓ have a fever or the chills
- ✓ feeling unwell or are really tired
- ✓ more short of breath
- ✓ having chest tightness

You need:

- ✓ to be suctioned more often
- ✓ to take your puffers more often

Your ventilator:

- ✓ has higher than normal pressures

Your mucous:

- ✓ is thick and/or there is more of it
- ✓ is yellow or green
- ✓ has an unpleasant smell

Your stoma:

- ✓ is red, swollen or is painful

## What should I do if I have an infection?

- ✓ Call your doctor or healthcare professional if think you have an infection.
- ✓ Follow your doctor's orders on taking medicine, such as antibiotics.
- ✓ If you have an action plan, go over it with your healthcare professional. Do not be afraid to ask for advice.

## Washing Your Hands at Home

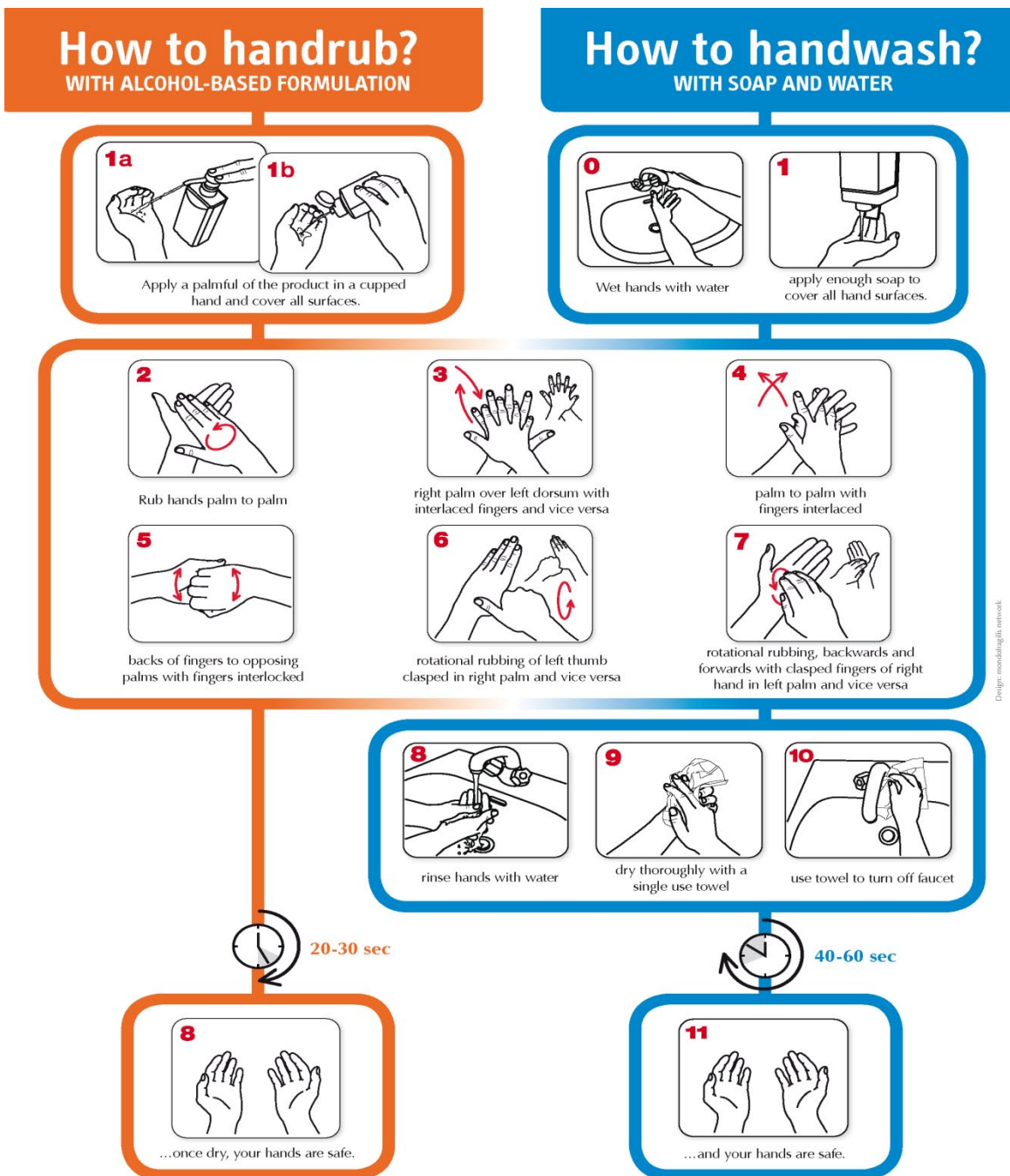

WHO acknowledges the Hôpitaux Universitaires de Genève (HUG), in particular the members of the Infection Control Programme, for their active participation in developing this material.



October 2006, version 1.

**Figure 10 : Hand Washing**

Reproduced with permission from the World Health Organization

Accessed on July 7, 2009 from: <http://www.who.int/gpsc/tools/GPSC-HandRub-Wash.pdf>

## Sterilizing Distilled Water

### Why do I need sterile distilled water?

You will be instructed to use sterile distilled water several times in this manual. To help stop infections from happening you need to make sure you use **sterile** distilled water.

You will need sterile distilled water when you:

- ✓ Suction the trach tube
- ✓ Fill a pass over humidifier
- ✓ Clean the tracheostomy opening
- ✓ Clean the trach tube inner cannula

Legionella is a germ that can grow in water. To stop germs from growing, use *sterile distilled water*. You can buy *sterile distilled water* or you can boil distilled water to sterilize it. You can buy distilled water from your home care company, drug store or supermarket.

---

**IMPORTANT! Only use distilled water that has been sterilized.  
This will help stop lung infections from happening.<sup>1</sup>**

---

### How do I make sterile distilled water?<sup>2</sup>

Follow the directions below to make enough sterile distilled water to last 2 or 3 days. Do not use the water after the 3rd day. Make or buy more.

1. Find one pan with a lid, large enough to boil enough water for 2-3 days. Use this pan for sterilizing distilled water **only**. Do not use this pan to cook with
2. Bring the distilled water to a boil. Let boil for 5 minutes<sup>3</sup>
3. Turn off heat and cover the pan. Never leave the pan unattended. Use the boiled distilled water as soon as it has cooled or put it in a clean container and seal. It does not need to be refrigerated
4. To sterilize the containers, put the containers in the water and let the water boil for 10 minutes. Turn off heat and cover the pan with a lid
5. Leave the lid on the pan while the water is cooling. Do not use ice to cool down the water

---

<sup>1</sup> The APIC Curriculum for Infection Practice, Vol. III. 1988.

<sup>2</sup> This section on distilled water is courtesy of Hamilton Health Science and Saint Elizabeth Care.

<sup>3</sup> <http://www.phoenixchildrens.com/emily-center/child-health-topics/handouts/Sterile-Water-Saline-861.pdf>

## Tracheostomy Care

---

### What is a Tracheostomy?

A tracheostomy is an opening made into the windpipe just below the vocal cords. The hole, called the stoma, is where the trach tube is put in. You can breathe and cough through the trach tube as long as it stays clear.

Your nose normally warms and moistens the air you breathe. With a trach, the air goes right into the lungs and not through the nose first. Without moisture your mucous will become thick and it will be hard to cough out. This can lead to problems breathing. There are ways to warm, filter and moisturize the air for those with a trach tube in place.

When you have a trach tube you need a way to moisten and filter the air. This can be done using a nebulizer, a humidifier or a heat moisture exchanger ('HME').

A trach tube can be cuffed or uncuffed. When the trach tube is cuffed, there is a balloon on the tube, called a cuff. When it is inflated it seals the airway. When the trach tube is uncuffed, some air can pass around the tube and up through the mouth and nose. People with a cuffed trach tube cannot speak when the cuffed balloon is inflated. This is because no air is reaching the voice box. If the trach tube is uncuffed or the cuffed tube has the balloon deflated, the person can often speak with the trach tube in the airway. There are devices that can help the person with a trach speak.

A tracheostomy tube is often called a "trach tube." There are many kinds of trach tubes.

You have a \_\_\_\_\_ trach tube

## How do I prepare to go home with a tracheostomy?

While you are in the hospital you and your support person will learn how to take care of your tracheostomy. Caregivers will visit you in your home on a regular basis. Your community respiratory therapist, nurse or personal support worker, will be available to help you care for your trach.

### Contact List

Make a Contact List with the following information:

- ✓ Include all your Doctors names and phone numbers
- ✓ Oxygen company, if you have one
- ✓ Ventilator Equipment Pool phone number
- ✓ Ventilator settings
- ✓ Trach tube information: size, type
- ✓ Emergency Phone numbers
- ✓ Your community healthcare support telephone number
- ✓ Community Care Access (CCAC) phone number
- ✓ Equipment supplier number, e.g. home care company
- ✓ Put the Contact List in a place where you and others can easily find it

### Diary

You may find that keeping a diary of your questions or problems will help you communicate with your healthcare professionals.

- ✓ Changes to the trach tube
- ✓ When it was changed
- ✓ What size tube was put in
- ✓ Why the tube was changed
- ✓ Changes to the ventilator settings
- ✓ When it was done
- ✓ What settings were changed
- ✓ Why it was changed

## Where should I do my trach care?

Consider a room that is private and away from distractions. It should be away from any open windows, heating ducts and fans. Children and pets should not be allowed in this room.

Your room should have:

- ✓ A mirror
- ✓ Good lighting
- ✓ A comfortable spot to sit or lie down
- ✓ Shelves or large drawers for all your supplies; they should be easy to clean

When doing your trach care:

- ✓ Do your care around the same time every day
- ✓ Set aside 20 to 45 minutes to complete the care and make sure you are not going to be interrupted. For example, do not answer the phone while you are doing your trach care
- ✓ Change the trach tube when your doctor tells you to. Some people need to change their trach tubes once a month. Others will be told when to change it
- ✓ Read the directions that are in the trach tube package

---

**IMPORTANT! If you have any questions, ask your doctor.**

---



## Description of Tracheostomy (Trach) Tubes

Trach tubes are man-made airways that are made to fit into a cut in your neck.

There are many kinds of trach tubes. They can be made from rubber, plastic, silicone, nylon, Teflon, polyethylene, or metal. The most common type of tube is made from a plastic called Polyvinyl Chloride (PVC). All trach tubes are made with non-toxic materials.

Everyone has a different size neck, so the tubes come in different sizes. The length can vary from 5cm to 15cm and the width of the opening can vary from 2mm to 12 mm wide.

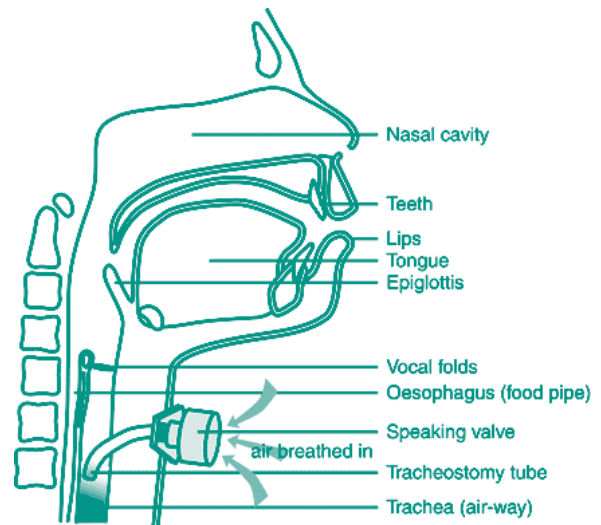
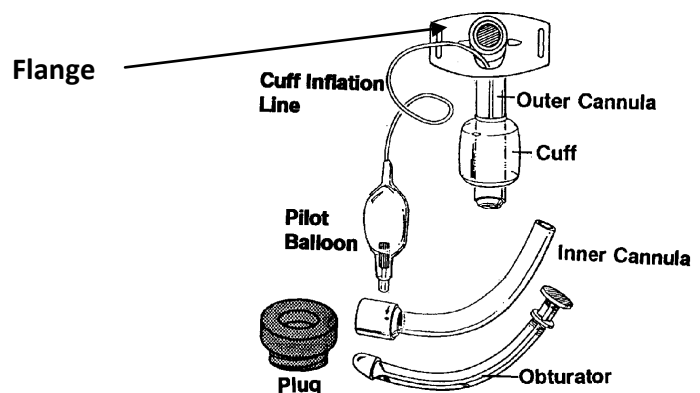

**Figure 11: Trach Tubes**

Reproduced with permission from Great Ormond Street Hospital for Children NHS Trust. Copyright GOSH 2008.

[http://www.ich.ucl.ac.uk/gosh\\_families/information\\_sheets/speaking\\_valves/inhalation.gif](http://www.ich.ucl.ac.uk/gosh_families/information_sheets/speaking_valves/inhalation.gif)

## Trach Tube Parts



**Figure 12: Trach Tube Parts**

Reproduced with permission from the Ohio State University Medical Centre (OSUMC).

<http://medicalcenter.osu.edu/pdfs/PatientEd/Materials/PDFDocs/procedure/tube-care/trach/fenestr.pdf>

### Obturator (OB-ter-ay-ter)

- ✓ This is an important piece. The obturator goes into the trach tube and is used to put the trach tube in the stoma (opening). It is also used when changing trach tubes
- ✓ The obturator is specially made for the size of trach tube in that package. So you will not be able to use an obturator from one size trach tube to put in a tube that is a different size

---

**IMPORTANT! Keep the obturator somewhere where it is easy to find. If the trach tube falls out by accident, you need to use the obturator that came with that trach tube to put the trach tube back in.**

---

### Inner Cannula (CAN-you-luh)

- ✓ This is a smaller tube that fits inside the trach tube. It can be removed quickly if it becomes blocked with mucous
- ✓ Most inner cannulas are disposable, but some inner cannulas are reusable and need to be cleaned. Ask your nurse or respiratory therapist about what type you have and how to take care of it
- ✓ Some trach tubes do not have an inner cannula

### Cuff

- ✓ Trach tubes are made with and without cuffs. An uncuffed trach tube has no cuff and no pilot balloon. A cuffed trach tube has a balloon-like device at the end
- ✓ The cuff is a small balloon that is at the end of the trach tube. When this balloon is inflated it seals against the wall of your windpipe. A seal is often needed when you are on a ventilator. The seal stops the air flow from going into your mouth
- ✓ Some cuffs are filled with air, some are filled with water. It is important to know what your cuff needs to be filled with
- ✓ The cuff needs to be filled (inflated) with the smallest amount of air, or water to seal the airway
- ✓ When you inflate the cuff you are putting air or water into the *pilot balloon*. When the cuff is full of air or water it is said to be “up”. There is a set amount of air or water to fill the cuff and it is measured with a syringe. The amount of air (or water) will be different for each person and will depend on the size of the trach tube
- ✓ Be careful when inflating the balloon. Too much pressure can cause damage to the windpipe. Have your nurse or respiratory therapist shows you how to properly fill your cuff

- ✓ When the cuff is flat, or deflated, it said to be “down”. When the cuff is down there is no seal against the windpipe wall and air can go up through the vocal cords and out the mouth

### Cuff Inflation Line

- ✓ This is a thin piece of tubing that carries air to and from the cuff

### Flange or Neck Plate

- ✓ This is the piece found at the top of the trach tube that lies flat against the neck and has holes to secure the trach ties to. The flange will have the brand and size of trach tube printed on it

### Ties or Trach Holder

- ✓ Ties are used to hold the trach tube to the neck so it will not fall out. There are foam, Velcro®, and twill trach ties
- ✓ Care must be taken when putting the trach ties on. They are not to be tied too tight or too loose. When tied correctly you will be able to fit one or two fingers between the trach ties and the neck

### Cork

- ✓ The cork is a plug for the trach tube. It is also called a button, plug, or cap, depending upon the type of tube. When the cork is placed over the trach tube, it seals off air entering the trach tube
- ✓ When the cork is in place the cuff is to be ‘down’ or deflated, so you can breathe around the trach tube. This will allow air to pass over the voice box allowing you to talk

---

**IMPORTANT! Make sure the cuff is deflated, or in the “down” position before using a cork. Take off the cork before you inflate the cuff.**

---

## Speaking Valve

- ✓ These are one-way valves. When using a speaking valve, you need to first put the cuff 'down'. When the valve is placed on the end of the trach tube, air goes into your lungs when you breathe in. When you breathe out the valve shuts and the air will go up through your voice box and out your mouth. This will allow speech
- ✓ Speaking valves can also help with coughing and swallowing

---

**IMPORTANT! Make sure the cuff is deflated, or into the "down" position before using a speaking valve. Take off the speaking valve before inflating the cuff.**

---

## Types of Trach Tubes

There are many kinds of trach tubes; there are Portex, Shiley and Bivona TTS Tubes

### Bivona TTS Tubes

- ✓ A *Bivona Tight-to-the shaft (TTS) Tube* is made of silicone and has no inner cannula
- ✓ *Cuffed Bivona TTS Tube*. When the cuff is deflated, it flattens very close to the shaft of the trach tube, allowing for speech. Fill the cuff with sterile distilled water
- ✓ *Uncuffed Bivona Tube*. It looks the same as the Bivona TTS tube except there is **no** cuff or pilot line

### Cleaning Bivona Tubes

- ✓ You can re-sterilize these tubes up to 10 times.
- ✓ These tubes have a special Superslick® coating on them that keeps mucous from sticking to them. Do not scrub too hard or the coating will come off.



**Figure 13: Bivona Tubes**

Reproduced with permission from Smiths Medical North America <http://www.smiths-medical.com/upload/products/mainImages/670180.jpg>

---

**IMPORTANT! Only use sterile distilled water to inflate TTS tube cuffs. If you fill it with air, it will leak.**

---

### Portex and Shiley Tubes

These tubes are made of plastic and can come with or without a cuff. If these brands have a cuff, the cuff is always filled with air. Some models have an inner cannula, some do not. The Portex BlueLine Ultra tubes are colour coded.

---

**IMPORTANT! Always fill Portex and Shiley tube cuffs with air. Never fill with water.**

---

See your personal information for your tube and size.

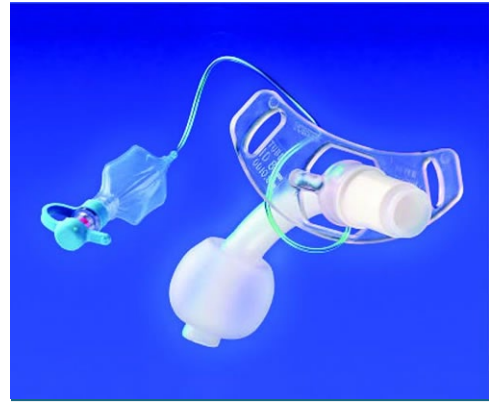

**Figure 14 : Portex Tube**

Source: [www.vitalitymedical.com/isroot/Stores/VitalityMedical/picxl/S PX505080.jpg](http://www.vitalitymedical.com/isroot/Stores/VitalityMedical/picxl/S PX505080.jpg)



**Figure 15: Shiley Tubes**

Reproduced with permission from the American College of Chest Physicians (Pulmonary & Critical Care Updates; Vol. 18, lesson 15)  
[www.chestnet.org/images/education/online/pccu/vol18/lesson15/fig1.jpg](http://www.chestnet.org/images/education/online/pccu/vol18/lesson15/fig1.jpg)

## How do I know when I should replace my trach tube?

You need to replace your trach tube when the:

- ✓ Obturator is too tight
- ✓ Trach shaft is not centred
- ✓ Trach tube is 'off color'
- ✓ Trach tube markings have faded

---

**IMPORTANT! Always have an extra trach tube with you at all times. Have a trach tube that is one size smaller than one in use. Keep the obturator on hand at all times.**

---

- ✓ My trach tube type is: \_\_\_\_\_
- ✓ The trach tube size is: \_\_\_\_\_
- ✓ My trach has an inner cannula
- ✓ My trach does not have an inner cannula
- ✓ My trach has a cuff:
  - needs to be filled with \_\_\_\_\_ ml of air
  - needs to be filled with \_\_\_\_\_ ml of water
- ✓ My trach does not have a cuff

## Stoma Care

The stoma is the hole made in your windpipe that is kept open with a trach tube. Stoma care is the cleaning of the skin around the opening in the neck. Good stoma care will help prevent infections. Do stoma care at least once a day, such as first thing in the morning or just before going to bed. Clean it more often when the skin is swollen, red, or tender to touch.

### How do I clean the stoma?

1. You will need:
  - ✓ Sterile distilled water (or sterile normal saline)
  - ✓ Cotton tipped swabs or gauze
  - ✓ Sterile trach dressings
  - ✓ Disposable cups for water
  - ✓ Suction equipment
  - ✓ Disposable gloves
2. Wash hands well
3. Put on clean gloves
4. Make sure you are in a comfortable position and can see the trach area easily. You may find using a mirror helpful
5. Suction, if needed

---

**IMPORTANT! Make sure the trach tube is stable and not at risk of falling out during the cleaning process.**

---

6. Take off the old dressing and throw it in the garbage. Note the colour of the mucous, the amount of mucous and if there is any unpleasant smell
7. Check the skin around the trach opening (stoma) every day for signs of an infection

Watch for:

- ✓ Redness or swelling
- ✓ Creamy yellow or green mucous
- ✓ Crusting, dry mucous
- ✓ An unpleasant smell
- ✓ Pain or tenderness around the stoma
- ✓ Any extra tissue growth

Take note of any differences and report them to your healthcare professional

8. Dip a cotton swab or gauze in sterile distilled water and clean the area around the opening, gently removing any dried mucous
9. Clean from the skin opening outward. Check to see that the opening is not open more than usual. Throw away each swab or gauze after use
10. Dip a new cotton-tipped swab or gauze in sterile distilled water and clean/rinse the area
11. Dry with fresh applicator swab or gauze
12. Put on the sterile dressing being careful not to twist the trach tube or pull on the flange
13. Change trach ties when they are dirty or when the Velcro® is no longer holding properly
14. Pour the water into the toilet and clean the containers
15. Take off gloves and wash hands well
16. Gather clean supplies so they are ready for the next cleaning



**Figure 16: Stoma Care**

Reproduced with permission from the Ohio State University Medical Centre (OSUMC)  
<http://medicalcenter.osu.edu/pdfs/PatientEd/Materials/PDFDocs/procedure/tube-care/trach/t-non-di.pdf>

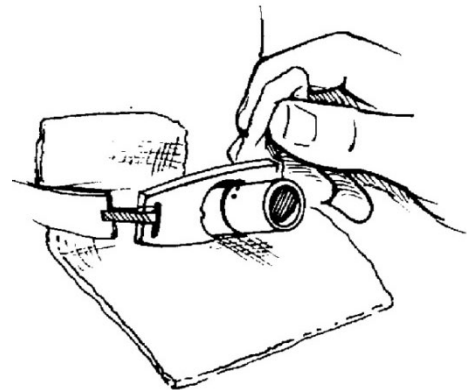

**Figure 17: Putting on the trach dressing**

Reproduced with permission from the Ohio State University Medical Centre (OSUMC)  
<http://medicalcenter.osu.edu/pdfs/PatientEd/Materials/PDFDocs/procedure/tube-care/trach/t-non-di.pdf>

---

**IMPORTANT! Dirty swabs and dressings may cause infections so they should be thrown away carefully. Wrap them in a plastic or paper bag and then put them in the garbage.**

---



## Trach Tube Care

### How do I clean my inner cannula and corks?

Many trachs have an inner cannula that needs to be cleaned or replaced on a daily basis. If there is a lot of mucous in the inner cannula, you need to clean it more often. Proper cleaning of the inner cannula will help stop lung infections from happening.

### Daily

1. You will need:
  - ✓ A clean inner cannula, cork or speaking valve
  - ✓ Cotton tipped swabs or gauze
  - ✓ Tweezers
  - ✓ Pipe cleaners
  - ✓ Clean small plastic bags or dry container
  - ✓ Suction machine and supplies
  - ✓ Disposable gloves
  - ✓ Two covered containers to be numbered and labelled
2. Label the containers #1 and #2 to avoid mixing up the clean and dirty containers
3. *Container #1* is for the dirty cannula and corks. Pour hydrogen peroxide or sterile distilled water into this container
4. *Container #2* is to rinse the cleaned cannula and corks. Pour sterilized distilled water into this container
5. Wash hands well and put on clean gloves
6. Make sure you are in a comfortable position. Make sure you can see the trach area easily. You may find using a mirror helpful
7. Suction, if needed
8. Remove the dirty inner cannula, the cork or speaking valve from the trach tube and place it into container #1 (hydrogen peroxide or sterile distilled water)
9. Put in a clean inner cannula, cork or speaking valve and lock in place

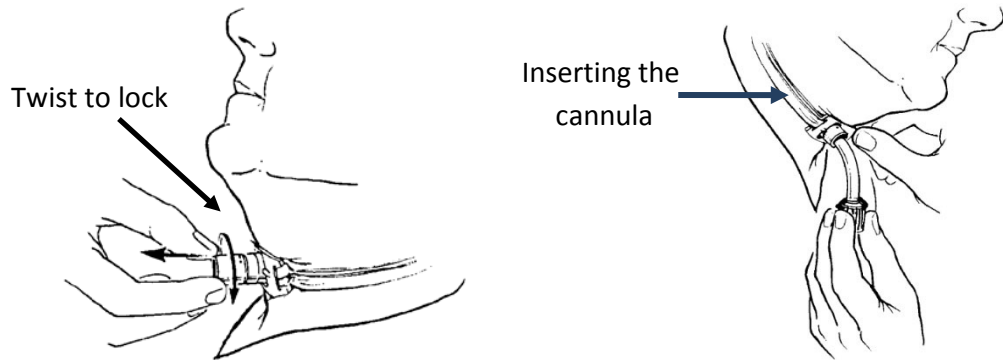

**Figures 18, 19: Cleaning the Cannula**

Reproduced with permission from the Ohio State University Medical Centre (OSUMC)  
<http://medicalcenter.osu.edu/pdfs/PatientEd/Materials/PDFDocs/procedure/tube-care/trach/t-non-di.pdf>

10. Remove the **dirty** cannula from **container #1** with tweezers and clean with a cotton swab, gauze, or pipe cleaners. Do not scrub
11. Look for cracks or breaks in the tube and locking mechanism. If there are cracks or breaks the trach tube needs to be changed
12. Place the cannula in **container #2** (sterile distilled water) and **rinse** well
13. Remove the cleaned cannula from container #2 (sterile distilled water) with the tweezers
14. Dry the outside of the inner cannula with clean dry gauze. Tap it against the gauze to remove any drops of water from inside the cannula



**Figure 20: Drying the inner cannula**

Reproduced with permission from the Ohio State University Medical Centre (OSUMC)  
<http://medicalcenter.osu.edu/pdfs/PatientEd/Materials/PDFDocs/procedure/tube-care/trach/t-non-di.pdf>

**IMPORTANT! Do not whip or shake the cannula to remove drops as this can spread drops into the air.**

15. Store the now clean inner cannula in a small clean plastic bag or dry container
16. Throw out all soiled supplies, along with the dirty distilled water and hydrogen peroxide
17. Wash all containers in soap and water. Rinse well. You can wash the containers on the top shelf in the dishwasher

18. Take off gloves and wash hands well
19. Get clean supplies ready for the next use

---

**IMPORTANT! Be sure to change the distilled water and hydrogen peroxide every day!**

---

### Weekly

Soak each container and lid in a solution of 1 part vinegar and 3 parts water for 20 minutes. Rinse and let air dry.

### How do I clean a metal or silver trach tube?

Hydrogen peroxide can damage these tubes. If you have a metal or silver trach tube, ask your respiratory therapist for cleaning instructions.

### How do I change my trach ties? <sup>4</sup>

Keeping the trach ties clean and dry will prevent skin irritation, sores and infections from occurring around the neck area.

The only thing holding your trach tube in place is the trach ties. These ties are usually made of twill cotton or cloth with a Velcro® closure.

When changing the ties be careful not to accidentally remove the trach tube. The ties should be changed by two people. One person will hold the trach in place, while the other person cleans the skin and changes the ties. If a second person is not around to help, tie the clean ties first and then remove the old ones. This will keep the trach tube from coming out by accident.

---

<sup>4</sup> This section on changing trach ties is courtesy of "Changing Tracheostomy Ties" from the Department of Inpatient Nursing, The Ohio State University Medical Center 2005  
<http://medicalcenter.osu.edu/pdfs/PatientEd/Materials/PDFDocs/procedure/tube-care/trach/changing.pdf>

**Change the tie tapes daily and as needed.**

1. You will need:
  - ✓ New trach tube ties
  - ✓ Clean gloves
  - ✓ Ask second person to assist, if available
  - ✓ Tweezers
  - ✓ Scissors
  - ✓ Suction machine and supplies
  - ✓ Tracheostomy Kit
  
2. Make sure you are in a comfortable position. Make sure you can see the trach area easily. You may find using a mirror helpful
3. Wash hands well and put on clean gloves
4. Have the second person hold on to the trach tube by gently holding onto the edges of the flange
5. Cut and remove the dirty trach ties. If you have a pilot line on the cuff, take care that you do not cut it by accident
6. Put one end of the clean trach tie through the hole on one side of the flange. Use the tweezers to pull the trach tie through the hole
7. Pull the ends of the ties so they are even
8. Bring both pieces of the ties around the back of the neck to the other side of the trach flange
9. Using tweezers take one end of the tie and pull it through the hole on one side of the flange
10. Bring the ends of the tie to the side of the neck and tie them in a knot

Example of one method of securing cotton ties



**Figure 21: Securing Trach Ties**

Reproduced with permission from the Ohio State University Medical Centre (OSUMC)

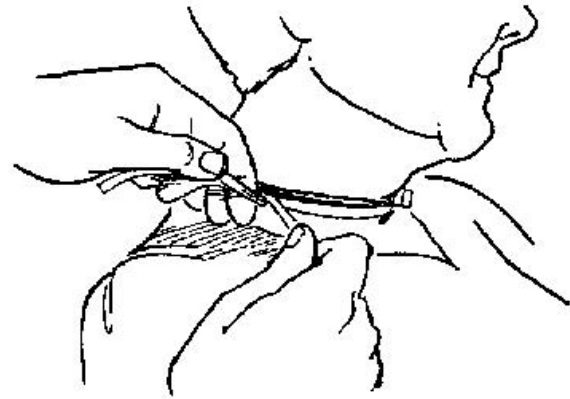

**Figure 22: Assisting with Trach Ties**

Reproduced with permission from the Ohio State University Medical Centre (OSUMC)

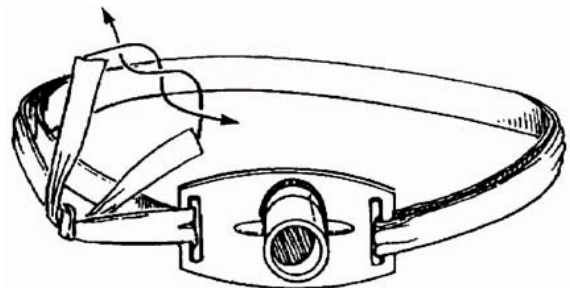

**Figure 23: Securing Trach Ties**

Reproduced with permission from the Ohio State University Medical Centre (OSUMC)

11. Do not tie them too tightly. Allow enough space for 1-2 fingers between your neck and the trach ties. To check this, place 1 or 2 fingers under the tie at the side of the neck, your fingers should fit snugly under the tie
12. Take off gloves and wash hands well

## Other Information About Trach Tubes

### What is a cuff?

The cuff is a balloon around the outside of the trach tube. When the balloon is inflated it fits the shape of your windpipe and it seals off the space between the wall of your windpipe and the trach tube. This seal might be needed if you are on a breathing machine (ventilator). If the cuff is not inflated, air can pass around the outside of the trach tube up through the voice box.

The cuff is inflated by putting either air or water in through the pilot line. If you have a cuffed *Shiley* or a *Portex* trach tube, you will fill the balloon with *air*. If you have a *Cuffed Bivonia TTS Tube*, you will fill the balloon with distilled *water*.

The pilot balloon on the inflation line shows whether the cuff is 'up' or 'down'. The pilot balloon does not tell you how much air or water is in the cuff. Ask your respiratory therapist or nurse how much air or water needs to be in your cuff.

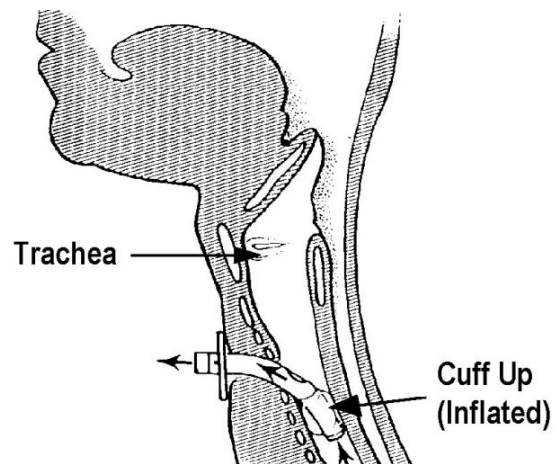

**Figure 24: Inflated Cuff**

Reproduced with permission from the Ohio State University Medical Centre (OSUMC)

---

**IMPORTANT! Make sure that you know how much air or water needs to go into your cuff. Ask your healthcare professionals to show you how.**

---

### Deflating the Cuff – Putting the Cuff “down”

1. Suction the mouth, if needed

**Note:** Sometimes mucous sits in the throat or on top of an inflated cuff. When the cuff is deflated, this mucous can fall from around the cuff into the lungs making you cough. It is a good idea to have a suction catheter ready in case this happens.

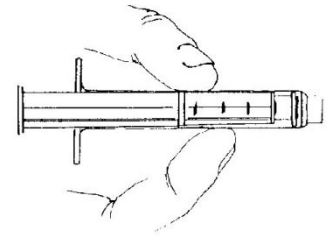

**Figure 25: Syringe**

Reproduced with permission from the Ohio State University Medical Centre (OSUMC)

2. Get a syringe (without the needle) and push the plunger all the way in to remove the air from the syringe
3. Attach the syringe to the cuff pilot line
4. Slowly pull back on the plunger of the syringe until the pilot balloon on the cuff pilot line is flat and the syringe plunger cannot be pulled back any more
5. You have now deflated the cuff

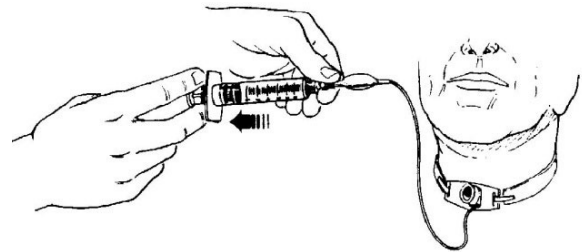

**Figure 26: Deflating the Cuff**

Reproduced with permission from the Ohio State University Medical Centre (OSUMC)

### Inflating the Cuff- Putting the Cuff “up”

1. Make sure that the trach tube is not blocked, so the air can move freely through it. Before inflating the cuff, attach a syringe to the cuff pilot line. Draw back on the syringe to suck out any air that may be in the cuff. The cuff needs to be fully “down” before filling it again. If the pilot balloon already has air in it you should **not** add more air

**IMPORTANT! Never add air to a cuff that already has air in it.**

- ✓ My trach has a cuff that needs to be filled with:
- ✓ \_\_\_\_\_ml of air (Shiley or Portex tubes)
- ✓ \_\_\_\_\_ml of distilled water (Bivona TTS Tube)

2. Attach the syringe to the cuff pilot line. Slowly push the plunger in so the air (or distilled water) fills the cuff with the right amount
3. Remove the syringe. There is a valve in the pilot line that stops the air or water from leaking out
4. If there is a leak around the cuff, see “How do I fix a Cuff Leak?” question below

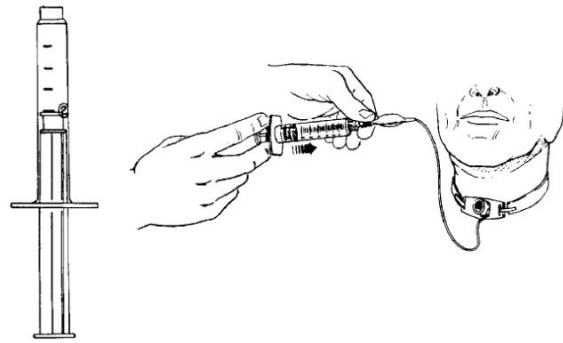

**Figure 27: Inflating the Cuff**

Reproduced with permission from the Ohio State University Medical Centre (OSUMC)

---

**IMPORTANT! If the cuff is filled with too much air or water, it will cause damage to the trachea. Do not over inflate the cuff.**

---

### How do I fix a cuff leak?

First remove all the air (or distilled water) from the cuff. Then reinflate the cuff with the right amount of air or distilled water. Wait a few minutes. If there is a leak, then:

1. Remove all the air or distilled water from the cuff
2. If the amount removed was less than it was suppose to be, and then re-inflate with the correct amount
3. If your cuff is filled with air you can try this. Put the pilot balloon in a cup of water while it is “inflated”. If you see bubbles then there is a leak in the pilot line or pilot balloon
4. If there is still a leak, the trach tube needs to be changed

### I have tried everything and there is still a leak in the cuff, what do I do now?

If you have been given directions on how to do this, and you are comfortable doing a trach change, then change the tube. If you have not been told what to do, or you are not comfortable call your home care worker or respiratory therapist for help. If no one is available to help , go to the nearest emergency room.

## Speaking Valves

A speaking valve is a one-way valve that allows air in but not out. The one-way valve connects to the trach tube and only opens when you breathe in, letting air go into your lungs. The valve will close when you breathe out, forcing the air up around the outside of the trach tube, through the voice box, and out your mouth, so you can speak.

There are many brands of speaking valves, but the Passy Muir valve is the most common. Speaking valves can be used while you are on humidity or oxygen and even if you are on a ventilator.

Speaking valves can improve:

- ✓ Swallowing – You will be less likely to choke on your food
- ✓ Smelling – You will smell your food and improve your appetite
- ✓ Coughing – You will have a stronger cough and will not need to be suctioned as often

## Special Considerations

- ✓ Do not use with inflated trach cuff
- ✓ The valve may occasionally pop off; just be sure connections are tight
- ✓ The valve can be attached to the trach tie with a fastener

### Remove the speaking valve when:

- ✓ Having an aerosol treatment
- ✓ Suctioning is needed
- ✓ Sleeping



**Figure 28: Passy-Muir® Tracheostomy Speaking Valve**

This section on speaking valves is courtesy of “Passy-Muir® Tracheostomy Speaking Valve” from the Department of Inpatient Nursing, The Ohio State University Medical Center, 2002

<http://medicalcenter.osu.edu/pdfs/PatientEd/Materials/PDF/Docs/procedure/tube-care/trach/passey.pdf>

---

**IMPORTANT! Never use a speaking valve when the cuff is “up” or in the inflated position.**

---



✓ Your trach speaking valve is: \_\_\_\_\_

**Figure 29: One Way Valve**  
Reproduced with permission from the Ohio State University Medical Centre (OSUMC)

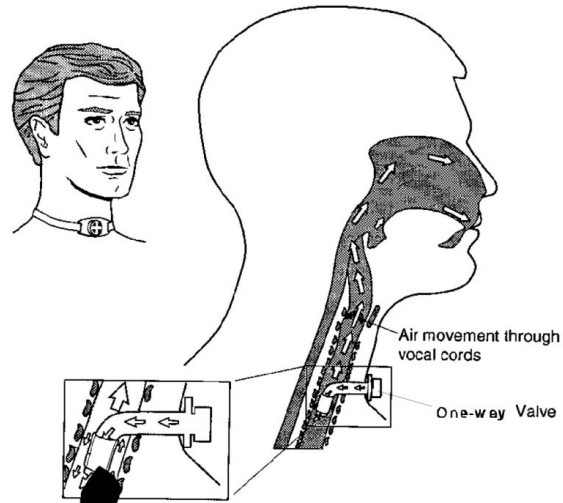

## How do I use a speaking valve?

**If you are not on a ventilator and are able to breathe on your own:**

1. Cough out any mucous in your lungs or mouth. If the mucous cannot be coughed out, then suction it out
2. Completely deflate the trach tube cuff
3. Remove the oxygen and humidity, if you have it on

To put the valve on:

1. Gently hold on to the edges of the trach tube flange and put the speaking valve onto the trach tube
2. Twist the valve gently to make sure it is on the trach tube properly. The valve may sometimes pop off. If this happens just replace it and be sure the connection is tight
3. Replace the oxygen and humidity, if you have it

To remove the valve:

1. Gently hold the flange and twist the valve off
2. Replace the oxygen and humidity, if you have it

**If you are on a ventilator and cannot breathe on your own:**

1. Cough out any mucous in your lungs or mouth. If the mucous cannot be coughed out, then suction it out
2. Completely deflate the trach tube cuff (put the cuff 'down')
3. Place the valve in-line with the ventilator tubing in the following way. Have your nurse or respiratory therapist fill in the steps you should follow below:

a. \_\_\_\_\_

b. \_\_\_\_\_

c. \_\_\_\_\_

4. Change the ventilator settings to:

FiO<sub>2</sub> or O<sub>2</sub> litre flow: \_\_\_\_\_ Tidal Volume: \_\_\_\_\_

Pressure Control: \_\_\_\_\_

Alarms: Low Pressure; test to be sure that the Low Pressure Alarm is working with the valve in-place

5. To remove the valve, take the valve out of the ventilator circuit

6. If you are on a ventilator return the settings to:

FiO<sub>2</sub> or O<sub>2</sub> litre flow: \_\_\_\_\_ Tidal Volume: \_\_\_\_\_

Alarms: \_\_\_\_\_

Other: \_\_\_\_\_

7. When the speaking valve is removed, it is safe to inflate the cuff again

### How do I clean my speaking valve?

If you take care of these valves they will last a long time. Before replacing a valve with a new one, first wash and dry it carefully. If the valve is still sticky, noisy or begins to vibrate talk to your respiratory therapist for more information.

Clean the speaking valve **every day** using a mild soap and warm water. Rinse well. Allow to air dry. When dry, store it in sealed plastic container.

Some cleaning products will damage the valve.

---

**Do not use the following:**

**Hot water or harsh chemicals**

**Hydrogen Peroxide, bleach**

**Alcohol**

**Cleaning brushes**

---

### Trach Kit

- Trach tube of current size
- Trach tube that is half a size smaller than the current one
- Obturator
- Trach ties
- Water soluble lubricant
- Normal saline nebulers
- Trach gauzes
- Scissors
- Suction unit
- Suction catheters
- Suction tubing
- Oximeter with probe
- Manual Resuscitator Bag

## Tracheal Suctioning

Suctioning removes mucous from the windpipe and the trach, keeping the airway open. A suction catheter is a tube that is used to take out mucus from the lungs and mouth.

- ✓ Patient specific suction unit pressure set at<sup>5</sup>: \_\_\_\_\_
- ✓ Size of suction catheters to be used: \_\_\_\_\_ fr

***NOTE: The following steps to suction are directed towards the person doing the suctioning procedure.***

Suctioning is considered a **clean** process. It is not a sterile process. Clean disposable gloves are fine to use. You **do not need sterile gloves**. However it is very important to keep the process as clean as possible.

Sometimes masks and gloves are worn by the person doing the suctioning so that the mucous and germs are not transferred to them.

---

**IMPORTANT! Check your suction equipment every day;  
it must always be ready-for-use.**

---

<sup>5</sup> Simmons K.F. (1990). Airway Care. In Scanlan C.L, Spearman C.B., & Sheldon R.L.. (Eds.). (1990). Egan's Fundamentals of Respiratory Care (5<sup>th</sup> Ed). Toronto: The C.V. Mosby Company.

1. You will need:
  - ✓ Suction machine – electrical or portable
  - ✓ Suction tubing
  - ✓ Sterile Distilled water (flushing solution)
  - ✓ Clean container for flushing solution
  - ✓ Disposable suction catheters of correct size
  - ✓ Clean disposable gloves
  - ✓ Hand sanitizer
  - ✓ Manual resuscitation bag with flex hose and trach adapter, if needed
  - ✓ Extra inner cannula, if needed
  - ✓ Obturator
  - ✓ Suction unit plug and charger, if needed
  - ✓ Plastic bag for disposal of materials
2. Wash hands well
3. Fill the container with sterile distilled water
4. Attach the suction catheter to the connecting tubing of the suction machine
5. Turn on the suction machine and be sure there is good suction
6. Make sure the person you will be suctioning is in comfortable position. Their head should be above their shoulders
7. Put on clean gloves being careful not to touch anything except the catheter

---

**IMPORTANT! Use a clean suction catheter for each suction session.**

---

8. Withdraw the catheter from package slowly. Hold the catheter with your gloved hand 10 to 15 cm (4 to 6 inches) from the tip
9. Remove the cork, trach mask, ventilator or manual resuscitator bag from the trach, if needed
10. Gently put the catheter 4 to 5 inches into the trach opening. Stop if there is resistance or if there is a cough. It is normal for someone to cough when they are being suctioned. But not everyone will cough

---

**IMPORTANT! Do not push or force the catheter.**

---

11. If you hit resistance, pull back slightly
12. You are now ready to apply the suction. Cover the thumb hole on the catheter and slowly take the catheter out while twisting, or 'rolling' it between your fingers. You can pull the catheter straight out or roll it back and forth between your fingers. It all depends on what works best to remove the mucous. It takes practice to find what works best to remove the mucous

---

**IMPORTANT! Do not cover the thumb hole on the catheter until you are ready to suction. Suction only when you are removing the catheter.**

---

---

**IMPORTANT! The suction catheter should not be in the trach for more than 20 seconds.**

---

13. Rinse the catheter out by dipping the catheter tip into sterile distilled water and suction water through the catheter and suction tubing until it is clear. You can use the same catheter to suction a few times, as long as it is kept clean. However, if the catheter becomes blocked with mucous, remove it and use a new one
14. Ask the patient "Do you need to be suctioned again?" Suctioning is needed if you hear "gurgling" sounds during breathing. Repeat steps 10 to 14, if more suctioning is needed
15. Note: Suctioning can cause the patient to feel very short of breath. So take breaks between suction attempts. You may need to place the patient back on ventilator for a while or give them some manual breaths with the resuscitation bag in between the suctioning sessions
16. Look at the mucous being suctioned out. Take note of the amount, the colour, the thickness and the smell
17. When you are finished suctioning, put the cork, trach mask or ventilator back on the trach tube, if needed. Be sure to replace the cork/speaking valve and/or the heat and moisture exchanger (HME) after the suction session
18. Coil or wrap the suction catheter around the fingers and palm of one hand, then pull the cuff of the glove over the top of the coiled catheter to completely cover it. Throw out the gloves and dirty catheter. Throw out the suction catheter after each suction session
19. Turn off the suction unit
20. Empty and clean the suction drainage bottles and containers, if needed

21. Wash hands well
22. Be sure the suction equipment and supplies are ready for the next use. You never know when a trach patient needs to be suctioned. Have all your suctioning equipment ready in case you need it quickly

### **When should I suction?**

Many people suction at least once a day, such as first thing in the morning or before going to bed.

A person needs to be suctioned when they:

- ✓ Are not able to cough out the mucous
- ✓ Are having trouble breathing or breathing sounds harsh
- ✓ Are on a ventilator and the airway pressures are higher than normal
- ✓ Have mucous in the trach tube or in the ventilator tubing

### **Why does the person feel so short of breath when they are suctioned?**

The suction catheter removes both mucous and oxygen from the airway when suctioning. Try to keep the suction time to less than 20 seconds. This will help. Allow time between suction attempts to allow them to catch their breath.

You may also manually ventilate, using a manual resuscitator, before and after suctioning. This often helps move mucous up the airway so it is easier to suction or cough up. This may also help relieve the shortness of breath that occurs when being suctioned.

### **Why is blood coming up the suction tube?**

This may happen if the suction catheter is too large. Bleeding may also happen if the catheter is pushed too hard into the airway, causing tissue damage. Introduce the catheter gently. Do not force it if you meet resistance. You can prevent bleeding by using the right size catheter and not forcing the catheter down the airway.

## Suctioning on the go

Before going out make sure the portable suction unit is fully charged and you have all your supplies.

Portable suction supplies:

- ✓ Suction catheters
- ✓ Connecting tubing
- ✓ Gloves
- ✓ Masks
- ✓ Hand sterilizer
- ✓ Distilled water, if desired
- ✓ Spare inner cannula, if applicable
- ✓ Manual resuscitator
- ✓ Trach Kit

## Other Helpful Tips

- ✓ The same catheter may be used during each suction attempt as long as it has remained clean
- ✓ The same suction catheter should not be used for more than one suction session
- ✓ If the catheter becomes plugged, throw it out. Replace with another sterile catheter
- ✓ Some individuals may have to be manually ventilated (bagged) before and after suctioning  
This may help move mucous higher in the airway. This may also help with breathing
- ✓ Replace cork/speaking valve and/or the heat and moisture exchanger when needed
- ✓ Suctioning is a clean procedure so it does not require the use of sterile gloves. Clean gloves are used to act as a protective barrier so that secretions or organisms cannot be transferred to the caregiver.



## Changing the Trach Tube

Many people change their own trach tubes. Some people change their trach tube once a month, others change it more often. Some will change it if it becomes plugged or falls out by accident. The following are steps everyone in the family needs to know. In case of an emergency, you need to be prepared and know what to do. Everyone in the family should know what to do if the trach were to become plugged, or falls out by accident. Do a practice-drill at home, so you can remain calm if these situations arise.

For a trach change, it is best if you have a second person to help you.

1. You will need:
  - ✓ Clean or new trach tube with obturator; same size as the one that is currently in
  - ✓ One size smaller trach tube – in case of an emergency where you cannot get the new same size tube in
  - ✓ Trach ties
  - ✓ Supplies to clean the stoma
  - ✓ Syringe, if the tube is cuffed
  - ✓ Scissors
  - ✓ Sterile distilled water
  - ✓ Manual resuscitation bag and mask
  - ✓ Water soluble lubricant
  - ✓ Suction machine and suction catheter
2. Wash your hands well and put on clean gloves
3. Check the new trach tube:
  - ✓ Remove the trach tube from the package. Look at the new tube. If you notice any cracks or breaks get a new tube
  - ✓ If there is a cuff on the tube, check that it is working by inflating it and deflating it
  - ✓ Inflate the cuff with air or water, as ordered by your doctor. If you notice a leak, get another tube. If there are no problems, deflate the cuff completely
4. To keep the tube as clean as possible, touch only at the flange
5. Put the obturator into trach tube
6. Lubricate the end of the trach tube with a water soluble lubricant
7. Make sure the person is comfortable and lying on their back with their neck tilted slightly backward. To do this, some people find it helpful to put a rolled towel under their shoulders

8. Do stoma care, if needed
9. Suction, if needed
10. Have the second person hold the trach tube at the flange. Remove the old trach ties. Take care the trach tube does not fall out accidentally
11. If the patient has a cuffed tube, deflate the cuff completely
12. Take out the old trach tube but try not to pull it straight out. Use a motion that follows the curve of the trach tube
13. Guide the new trach tube into the stoma. Again, try using a motion that follows the curve of the trach tube
14. As soon as the new trach tube is in, remove the obturator
15. If the person is on a ventilator and has a cuffed tube, inflate the cuff
16. Place back on ventilator, or oxygen, if needed
17. Tie the trach ties and put on a clean dressing
18. Wash your hands

### **What should I do if I cannot get the trach tube in?**

1. Moisten the trach tube with sterile distilled water and try again
2. Make sure you are using the obturator and that the cuff is completely deflated
3. Make sure the neck is extended. You may need to reposition the person
4. If the person can breathe and is not in distress:
  - ✓ Ask the person to take a big breath in. Guide the tube in as they breathe in
  - ✓ Try to put in a smaller size trach tube in
5. Put the obturator into the stoma and gently pull down on the skin around the opening. This should open the stoma a little more giving you room to put in the smaller trach tube
6. If the smaller tube will not go in and the person is having trouble breathing:
  - ✓ Put the face mask on the manual resuscitator bag and place the mask over the nose and mouth to ventilate. You will need to cover the stoma
  - ✓ Have the second person call 911

**The trach tube is out a little, but has not completely fallen out.****What do I do?**

1. Deflate the cuff on the trach tube (if it has one)
2. Gently push the tube back in
3. Adjust the ties so the trach tube will not fall out

**What do I do if the trach tube is plugged?**

1. If the patient is on a ventilator, the high pressure alarm will probably go off
2. Check to see if the patient is having trouble breathing
3. If so, try suctioning. If the suction catheter does not go down the trach very far then it may mean that the tube is plugged
4. If the patient is having trouble breathing you will need to act fast. Remove the trach tube and insert a new one

# Mechanical Ventilation

---

## What is Mechanical Ventilation?

You may need a ventilator to move air in and out of your lungs because you cannot breathe well enough on our own. The ventilator can do all of the breathing (total support) or just partly help your own breathing effort (partial support). Most ventilators can also give extra pressure (PEEP pressure) to hold the lungs open so the air sacs do not collapse. Mechanical Ventilation can be done using a ventilator and a trach tube, a ventilator and a mask, or a ventilator and a mouthpiece.

### Total Support

Those people who need the ventilator to do all their breathing would be on total support. A trach tube is often used for those who need the ventilator to do all their breathing. People on 'total support' are not able to use a mask.

### Partial Support

This is when the person is able to breathe on their own in between the breaths delivered by the ventilator. The ventilator does not have to deliver the full breath, if the person has some breathing effort of their own.

## Why is Mechanical Ventilation Needed?

Certain lung diseases change how the respiratory system works. Mechanical ventilators are used when the:

- ✓ Brain cannot send signals to the lungs to breathe
- ✓ Lung is too stiff to expand fully
- ✓ Lung tissue is damaged causing breathing problems
- ✓ Muscles for breathing are not strong enough to move air in and out of the lungs
- ✓ Heart has been damaged and causes the lungs to work very hard

## Ventilator Settings

Below is a list of the most common ventilator settings. Your ventilator settings will depend on your ventilator type and mode.

## Modes of Ventilation

The ventilator mode is the how the ventilator delivers the breath.

Common ventilator modes are:

AC or C - Assist/Control or Control

IMV - Intermittent Mandatory Ventilation

SIMV - Synchronized Mandatory Intermittent Ventilation

CPAP- Continuous Positive Airway Pressure

PS - Pressure Support

When Pressure Support is working, the machine will deliver a set pressure when the person breathes a breath on their own. It helps to boost the breath, so it is larger than they might do on their own

PC - Pressure Control

This sets the highest pressure to be delivered during a breath. This pressure is held for the whole 'breathing in' time

**Ventilator Rate**

- ✓ Also known as Breath Rate and Respiratory Rate
- ✓ The number of breaths the ventilator delivers in one minute

**Tidal Volume**

- ✓ The amount of air the ventilator gives with each breath

**Inspiratory Time**

- ✓ The time it takes for the ventilator to give one breath

**Inspiratory Flow Rate**

- ✓ How fast the air travels during one breath

**I: E Ratio (Inspiratory to Expiratory Ratio)**

- ✓ The length of time it takes to breathe in compared to the time it takes to breathe out
- ✓ This is often expressed as a ratio

**Peak Inspiratory Pressure (PIP)**

- ✓ This shows the amount of pressure it takes to fill up the lungs when you breathe in
- ✓ The number shown may be slightly different with each breath
- ✓ Each person has a normal PIP
- ✓ The amount of pressure is displayed on the control panel of the ventilator, either as a number on a screen or on a gauge

**PEEP (Positive End Expiratory Pressure)**

- ✓ This is the pressure the ventilator holds at the end each breath. PEEP helps to keep the air sacs open so they do not collapse

**Sensitivity or Breathing Effort**

- ✓ This control shows how much effort is needed to start a new breath from the ventilator

### Low Pressure Alarm

- ✓ This is a safety alarm that goes off when the ventilator does not reach the pressure needed to give the full breath
- ✓ This usually means there is a leak somewhere in the tubing or that the ventilator tubing has come off the patient's trach tube. For a more information on low pressure alarms, see the **Troubleshooting** section

### High Pressure Alarm

- ✓ This is a safety alarm that goes off when the ventilator reaches the high pressure setting.
- ✓ This usually happens when:
  - There is a blockage in the airway, often caused by too much mucous. The patient might need to be suctioned
  - The patient is wheezing, coughing or hiccupping
  - There is a kink in the ventilator tubing

### Oxygen

- ✓ If your doctor wants to give more oxygen, it may be added into the ventilator tubing

Your ventilator is a: \_\_\_\_\_

The ventilator settings are: \_\_\_\_\_

---

## Ventilator Power Sources

Ventilators operate on electricity. There are three sources of electricity that are available to run the ventilator: Alternating Current (A/C), External D/C battery and Internal D/C battery

### Alternating Current (A/C)

Most of the time your ventilator will be plugged into your home wall outlet which is 120 volts of alternating current (A/C). Always use wall outlet power if you are planning to stay in one place.

### Internal Direct Current (D/C)

This is the battery inside the ventilator. It is used when there is a sudden drop in electricity to power the ventilator. This may happen when the ventilator is unplugged accidentally, or during a power failure. A fully charged battery should keep the ventilator working for about 30-60 minutes.

This battery should not be used often. This battery is a safety feature and is only to be used in an emergency. Keep the ventilator plugged into a wall outlet so the battery will always be charged.

The Internal D/C battery is:

- ✓ Built into the ventilator
- ✓ For short term emergency power only
- ✓ On when the ventilator is on
- ✓ On when you unplug the ventilator from the wall or an external D/C battery
- ✓ Recharged when the ventilator is plugged in to a wall outlet
- ✓ Able to power the ventilator for 30-60 minutes, if it is fully charged
- ✓ To be discharged and recharged every month

***Note: Depending on the ventilator, this battery may not recharge when the ventilator is plugged into a D/C external battery. Check with your respiratory therapist.***



## External Direct Current (D/C)

If a power failure were to last longer than 30-60 minutes, the battery inside your ventilator will not last. So you need to have another way to power the ventilator, if this were to happen.

The Ventilator Equipment Pool (VEP) provides an external D/C battery for emergencies such as a power outage. The battery is a standard 12 volt battery that would provide power to the ventilator for 5-12 hrs.

---

**IMPORTANT! This battery should not be used for portability, such as with a wheelchair. They are for emergency backup power only.**

---

## How do I hook up the external battery to the ventilator?

1. Check to make sure the battery is fully charged. If it needs charging, do so first. Never charge the battery while the battery is connected to the ventilator
2. Place the battery in a safe place away from the ventilator's inlet filter (on the back of the ventilator panel). Do not put the battery on top of ventilator
3. Plug the battery cable into the proper connection on the ventilator
4. Plug the battery cable into the battery

---

**IMPORTANT! Some internal ventilator batteries may not recharge when the ventilator is plugged into an external D/C battery.**

---

## How do I remove the external battery from the ventilator?

1. Unhook the battery cable from the battery
2. Unhook the battery cable from the ventilator
3. Make sure ventilator is plugged into the wall outlet (A/C power source)
4. Recharge the battery in a well ventilated area

## I would like to use my ventilator with my wheelchair. What battery should I use?

- ✓ A battery is needed when you use your ventilator with your wheelchair. You will need to buy another battery for this purpose

- ✓ Do not use the external battery that VEP has given you. That one is for emergency use only.  
**VEP does not supply batteries for wheelchair use**

### When do I need to recharge the external battery?

- ✓ Recharge the battery after every use in a well ventilated area
- ✓ Old batteries will lose their charge quickly so check the battery charge every week
- ✓ Discharge and recharge the battery monthly

### How do I recharge the external battery?

1. Charge the battery in a well ventilated area
2. Do not charge the battery when it is hooked up to the ventilator
3. Use a 12 volt battery charger to recharge the battery
4. Connect the battery to the charger
5. Connect the charger to the wall outlet (A/C power)
6. Let the battery charge. **Note: It will take one hour of recharge time for every hour that it was used**
7. When the battery is 80% charged, the yellow light will flash
8. When the battery is 90% charged the green light will come on. When the green light is on it means the charge is complete
9. Leave the battery hooked up to the charger for another 3 hours **after** the green light comes on
10. When the battery is fully charged, unplug the charger from the wall outlet first, before unhooking the charger from the battery

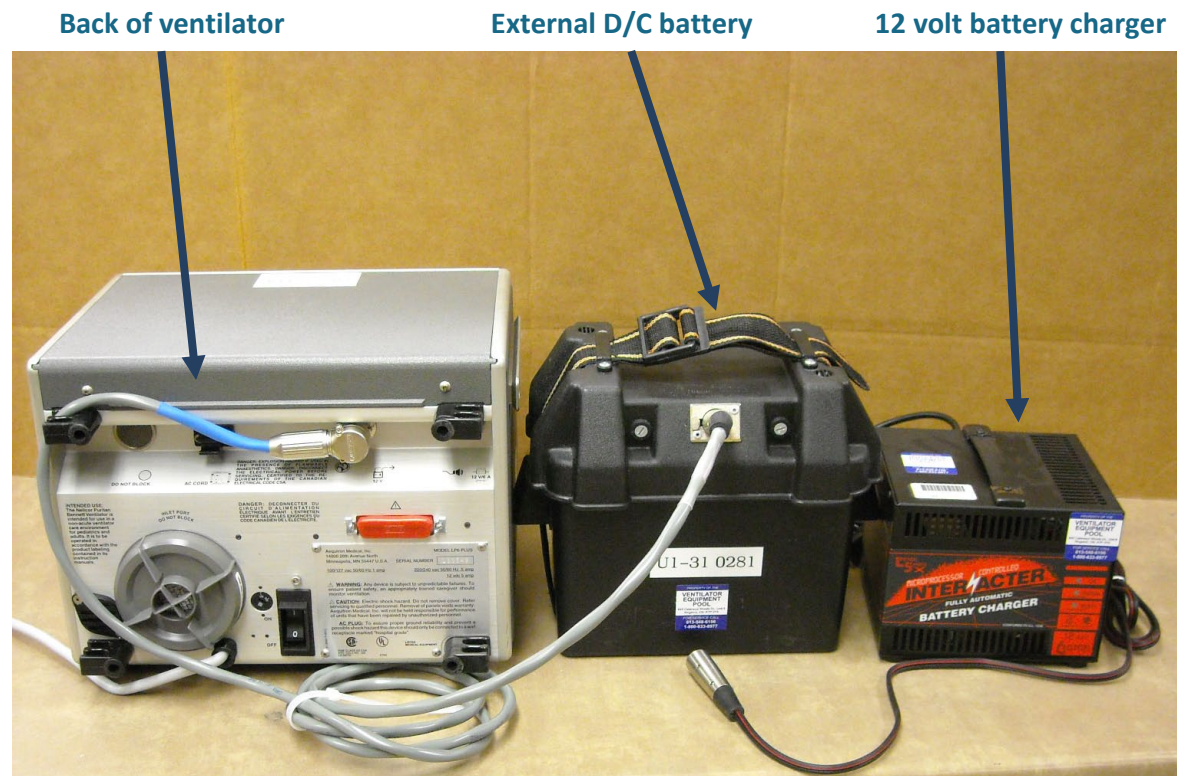

**Figure 30: Ventilator & Battery**

Photo courtesy of Ventilator Equipment Pool

### General Tips: Ventilator Management

- ✓ Place the ventilator on a night stand or a table away from drapes or other things that could block the air flow to the inlet filter opening
- ✓ Spills will damage the ventilator and cause it to not work properly. Never place food or liquids on top of the ventilator
- ✓ Use the protective doors, covers or lock out features on the ventilator. They protect the settings from being changed by mistake
- ✓ Make sure the humidifier is lower than your head
- ✓ Make sure the alarm port is not blocked by objects. If it is blocked, it may not be heard if it goes off

**Daily**

- ✓ Make sure the ventilator is plugged into a 3 - pronged wall outlet (A/C power source)
- ✓ Turn the ventilator on and check that the proper lights and sounds come on. Your ventilator manual will tell you what to look for
- ✓ Check the ventilator settings to make sure that they are set correctly
- ✓ Check the respiratory rate. To do this the person cannot be connected to the ventilator. Hold a glove tightly over the flex tube connector where it would attach to the patient. Count the number of breaths for one minute (60 seconds). It should be the same as the set breath rate on the machine
- ✓ Test the Ventilator Circuit by doing a 'Low Pressure Test' and a 'High Pressure Test'

**Weekly**

- ✓ Wipe down the ventilator with a damp cloth
- ✓ Clean and change the Ventilator Circuit
- ✓ Clean the Portable Suction machine
- ✓ Check that the external battery is charged

**Monthly**

- ✓ Change the bacteria filter in the breathing circuit
- ✓ Change or clean the inlet filters on the ventilator. These must be replaced/cleaned as needed
- ✓ Discharge and recharge the external battery

**Annually, or as needed**

- ✓ Preventive maintenance is recommended by the manufacturer. Some ventilators need to be serviced every 1-2 years, or after a certain number of hours of use
- ✓ The Ventilator Equipment Pool staff will call you when your ventilator needs maintenance

## The Ventilator Circuit

Below is a picture of a ventilator circuit. Your ventilator circuit may look a little different than this picture. Circuits are currently provided through the Ventilator Equipment Pool. Please see specific user's manual for circuit details

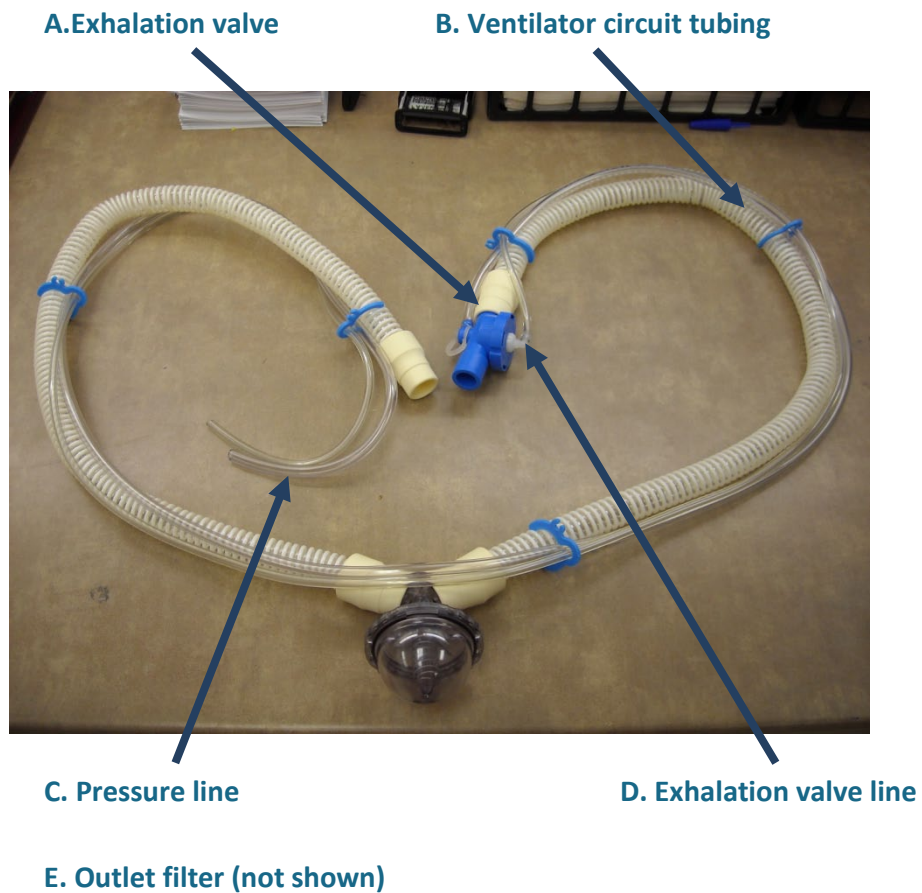

**Figure 31: Ventilator Circuit**  
Courtesy of Ventilator Equipment Pool

**A The *exhalation valve*:** is a balloon that closes when you breathe in and opens when you breathe out. The flex tube attaches to one end and the ventilator circuit tubing to the other end.

**B The *ventilator circuit tubing*:** is a 6 foot hose that attaches to the exhalation port at one end and to the outlet port on the ventilator on the other end.

**C The *pressure line*:** is a small tube that is connected to two pressure ports; one on the ventilator and the other on the exhalation valve.

**D The *exhalation valve line*:** is connected to the exhalation valve and the exhalation valve port on the ventilator.

**E The *outlet filter*:** *this filters gas coming from the ventilator, going into the ventilator circuit tubing (not shown in the picture above).*



**Figure 32: LTV 950 Ventilator**

Reproduced with permission of CareFusion [www.CareFusion.com](http://www.CareFusion.com)

Figure 32 shows the LTV 950 ventilator. Your ventilator may look different than the picture shown here.

### How do I clean and change the ventilator circuit?

Clean the ventilator circuit, resuscitation bag, humidifier and suction canister at least once a week.

1. You will need:
  - ✓ Mild dishwashing soap
  - ✓ Pail for soaking
  - ✓ Water
  - ✓ White vinegar
  - ✓ Clean towel
  - ✓ Storage bag
2. Take apart the ventilator circuit. This includes the tubing, connectors and humidifier reservoir jar, if used. Refer to your Patient Circuit Assembly Instructions

---

**IMPORTANT! The ventilator will *not* work properly if water gets into the pressure sensor line or exhalation valve.**

---

3. Wash tubing and connectors in warm soapy water
4. Rinse with tap water to remove the soap
5. Make a solution of 1 part vinegar to 3 parts water in the pail. Soak humidifier jar, tubing, and connectors in the vinegar solution for 30 minutes. Make sure that all the parts are in the solution
6. Drain and rinse well. Place connectors and humidifier jar on a clean towel to air dry. Hang the hoses to dry. Allow all parts to air dry completely before putting back together
7. Look carefully at the tubing and equipment for breaks or cracks. Check that everything is clean. Replace anything that is broken or cannot be cleaned properly
8. Put the ventilator circuit together, so it is ready to use. If it is to be stored, cover the circuit with a clean towel or store it in a clean plastic bag

## Testing the Ventilator Circuit

1. Inspect the Circuit
  - ✓ Make sure that all connections are tight
  - ✓ Make sure the humidifier and exhalation valve are put together properly
  - ✓ Check that the sensor lines are all connected
2. Do the “Disconnect Test” (Low Pressure Test)
  - ✓ Make sure the low pressure alarm setting is set correctly
  - ✓ Turn on the ventilator with the circuit connected
  - ✓ Do not connect the circuit. Wait to see if the low alarm goes off
3. If the alarm does not sound, check the alarm setting to make sure it is set correctly
4. If it still is not alarming:
  - ✓ Check the exhalation valve
  - ✓ Try another circuit or use another ventilator, if you have one. You may need to use a manual resuscitation bag to ventilate the person
  - ✓ Then contact the Ventilator Equipment Pool (VEP) right away if it is still not alarming
5. Do the “High Pressure Test”. The purpose of this test is to check that there are no holes or leaks in the tubing or connections
  - ✓ Glove one hand
  - ✓ Block the end of the trach adapter with your gloved hand and wait for the ventilator to give a breath
  - ✓ A high pressure alarm should sound after 1 - 3 breaths
  - ✓ If there is no alarm check the high pressure alarm setting to make sure it is set correctly  
Also check all the connections to make sure they are tight and secure
  - ✓ If still not alarming, try another circuit or use another ventilator if available

---

**IMPORTANT! Use a manual resuscitation bag to ventilate the patient. Call the Ventilator Equipment Pool (VEP) if your ventilator continues to not work.**

---



## Ventilator Safety and Troubleshooting

Below is some information to help you troubleshoot some common problems that may occur. For more information read the user manual supplied with your ventilator. Also read the “Problems and Emergency Manual”.

### What do I do if an alarm is sounding?

When a ventilator alarms you will see a warning light come on and hear a warning sound. Alarms are to alert you to a safety concern. **When an alarm goes off you need to pay attention to it right away!**

---

**IMPORTANT! Do not change the alarm settings!**

---

## Ventilator Troubleshooting Guide

Alarm	Possible Causes	Steps to Take
<p><b>Ventilator IN OP</b></p> <p>You will see a warning light and hear a warning sound.</p>	<p>There is a problem with how the ventilator is working</p>	<p>Turn the main power switch on the ventilator <i>off</i> and then <i>on</i> again. If the IN OP alarm is still alarming, <b>do not</b> use this ventilator</p> <ul style="list-style-type: none"> <li>✓ Switch to another ventilator, if available</li> <li>✓ Use manual resuscitator bag</li> <li>✓ Call VEP right away</li> </ul>
<p><b>High Pressure</b></p> <p>You will see a warning light and hear a warning sound.</p>	<ol style="list-style-type: none"> <li>1. Mucous is blocking the airway</li> <li>2. Wheezing or bronchospasm</li> <li>3. There is a respiratory infection</li> <li>4. Alarm setting is not set correctly</li> <li>5. Damaged Exhalation Balloon (valve)</li> <li>6. Kink in the tubing</li> <li>7. Water in tubing</li> <li>8. Coughing, swallowing or hiccupping</li> </ol>	<ol style="list-style-type: none"> <li>1. Suction to remove mucous.</li> <li>2. Give inhaled medicine</li> <li>3. Contact the healthcare professional</li> <li>4. Change alarm to proper setting</li> <li>5. Replace exhalation valve or change the circuit.</li> <li>6. Straighten the tubing</li> <li>7. Drain water</li> <li>8. If coughing, try suctioning</li> </ol>

Alarm	Possible Causes	Steps to Take
<p><b>Low Pressure/Apnea</b></p> <p>You will see a warning light and hear a warning sound.</p>	<ol style="list-style-type: none"> <li>1. Visual and auditory</li> <li>2. Leaks in the ventilator circuit (exhalation valve, humidifier, pressure line, holes in tubing)</li> <li>3. Water in the pressure line</li> <li>4. The ventilator has come off the patient's trach</li> <li>5. Leak around patient's trach and/or cuff</li> <li>6. Alarm set incorrectly</li> <li>7. Incorrect circuit</li> <li>8. Loose trach ties</li> <li>9. Loose inner cannula</li> </ol>	<ol style="list-style-type: none"> <li>1. Look and feel for any leaks. Do the "Disconnect Test"</li> <li>2. Recheck circuit and test</li> <li>3. Drain water</li> <li>4. Connect the ventilator to trach tube</li> <li>5. Verify the volume in the trach cuff. Deflate and reinflate cuff. Reposition the patient and/or tube. May need a trach tube change</li> <li>6. Set the correct alarm setting</li> <li>7. Change circuit</li> <li>8. Tighten trach ties</li> <li>9. Change inner cannula or change trach tube</li> </ol>
<b>Setting</b>	<ol style="list-style-type: none"> <li>1. Settings are incorrect</li> <li>2. Dirty inlet filter</li> </ol>	<ol style="list-style-type: none"> <li>1. Correct the settings</li> <li>2. Replace filter</li> </ol>
<b>Power Switch Over</b>	<ol style="list-style-type: none"> <li>1. Power source has changed from AC (wall outlet) to internal or external power source</li> <li>2. Power source has changed from external to internal</li> </ol>	<ol style="list-style-type: none"> <li>1. Make sure the ventilator is plugged in and there is power and press the reset button</li> </ol>
<b>Low Power</b>	Internal battery has drained and needs to be recharged	Operate ventilator on AC power for at least three hours

Always follow the instructions found in your ventilator manual.

**IMPORTANT! When a ventilator alarms, look at the person on the ventilator to see how they are doing. If they are not doing well, use a manual resuscitation bag to ventilate them.**

## Other Equipment

### Using and Cleaning the Portable Suction Unit

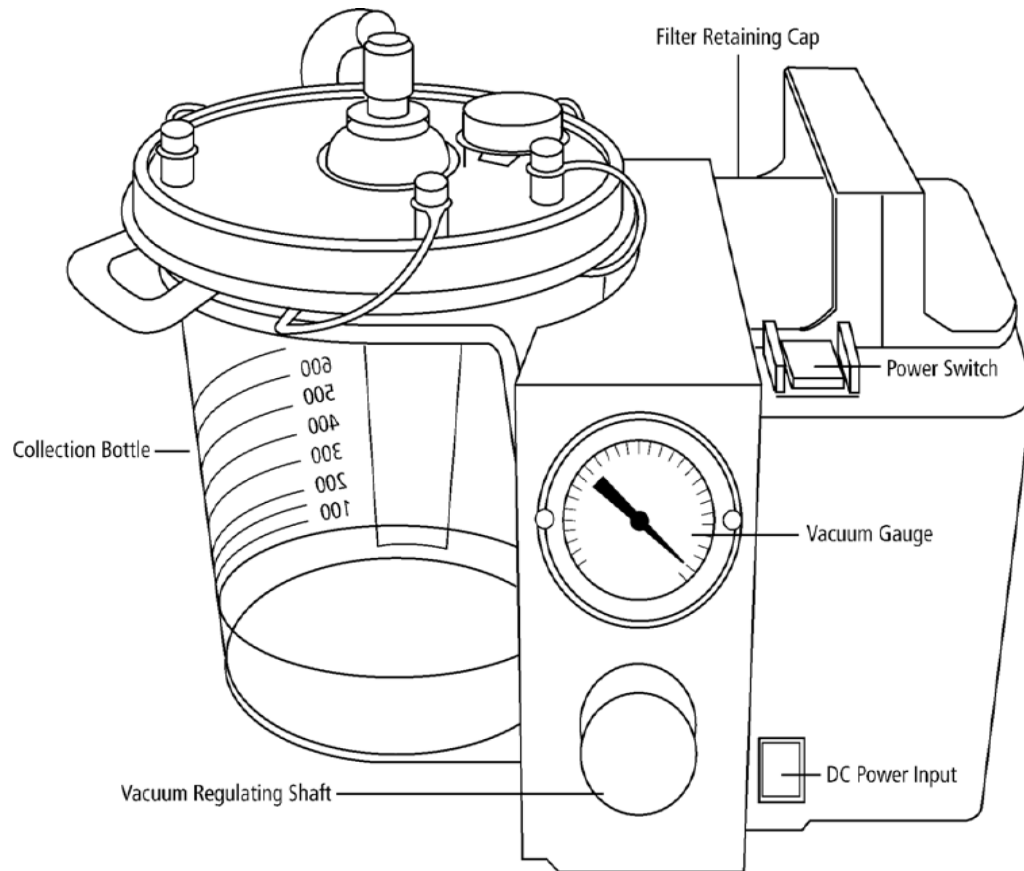

**Figure 33: Portable Suction Machine**

Reproduced with permission from Hamilton Health Sciences Centre

These units are portable so if you are going somewhere, make sure the machine's battery is fully charged and that you have all your supplies (see "Suctioning on the Go", page 37).

### How do you set the suction pressure?

The suction pressure is preset by your healthcare professional. To check the suction pressure, first turn on the unit. Then cover the open end of the connective tubing with your finger and look at the number on the gauge.

### How do I charge the battery?

Plug the portable suction machine into AC power (home wall outlet) when it is not in use. When using the machine on AC power, the on/off light will come on. When using the machine from the battery power the on/off switch **does not** light up.

### How do I clean the suction unit?

#### Daily

The canister should be emptied daily into the toilet. Wash it with soapy water and rinse well. Leave a little water in the bottom of the canister as it will stop mucous from sticking to the bottom.

#### Weekly

Clean the suction canister at least once a week.

1. You will need:
  - ✓ Mild dishwashing soap
  - ✓ White vinegar
  - ✓ Water
  - ✓ Two pails:
    - One for warm soapy water
    - One for vinegar (1 part) and water (3 parts) mix
  - ✓ Clean towel
2. Remove the short tubing from the lid. Unfasten the canister and remove the lid from the suction unit. Empty the contents into the toilet
3. Wash all parts in warm soapy water
4. Rinse with tap water to remove soap

5. Sink the pieces in one part vinegar to three parts water for **30** minutes. Rinse well and remove the extra water. Place parts on a dry towel to air dry
6. Put the tubing and canister back together. Look for any cracks and tears. Throw away and replace any broken or cracked parts
7. Wipe the machine down with a damp cloth
8. Change the connecting tubing weekly or when soiled
9. Wash hand well

### Monthly

Look at the filter and change it when it looks dirty or at least once every 2 months.

## The Manual Resuscitation Bag

The resuscitation (re-suss-i-TAY-shun) bag is a football-shaped bag that can help give breaths to someone who needs help breathing or is unable to take breaths on their own. When the bag is squeezed, the air leaves the bag and goes into the person's lungs. The air they breathe out goes out of the lungs and through a valve in the resuscitation bag. Manual resuscitations bags are also called "bags", "ambu bags" or "manual ventilators".

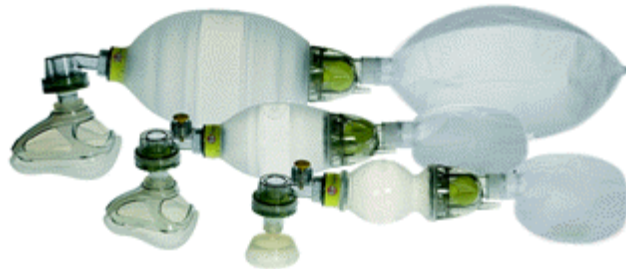

**Figure 34: Laerdal Bag**

Photo Courtesy of Hamilton Health Sciences, used with permission of Laerdal Medical Canada Ltd [www.laerdal.ca](http://www.laerdal.ca)

Your manual resuscitator bag may look different from the picture above.

### When do I need to use a manual resuscitator bag?

- ✓ When the person is having trouble breathing
- ✓ When there is a problem with the ventilator, or there is no power available to operate the ventilator
- ✓ Before and after suctioning, if needed

## How to use the Manual Resuscitator Bag

1. You will need:
  - ✓ Manual resuscitator bag
  - ✓ Adaptor for the trach tube
  - ✓ Flex hose/tube
  - ✓ Oxygen tubing, if needed
2. Take the patient off the ventilator
3. Connect the resuscitator bag to the patient's trach tube
4. Squeeze the bag gently – try to deliver about 1/3 - 1/2 the volume of the resuscitator bag  
Squeezing the bag should take about 1 second
5. Look at the patient to make sure:
  - ✓ The chest is rising
  - ✓ They are comfortable, are awake and aware of what is happening
  - ✓ They are not turning blue
6. As soon as you finish squeezing the bag completely, release the bag to let the patient breathe out. Make sure you give the person enough time to breathe out before squeezing the bag again
7. Squeeze the resuscitator bag in a regular pattern, about once every 4 - 5 seconds. Ask "Is this enough air? Do you want more?" Adjust how much and how fast and how much you are giving based on the person's needs and comfort level

---

**IMPORTANT! Never squeeze too hard on the manual resuscitator bag, as it could damage the lungs. Do not squeeze the bag too fast. If the patient is not responding while bagging, then call 911 right away.**

---

## How do I care for a Manual Resuscitator Bag?

A leak in the resuscitator bag will stop the right amount of air from filling the lungs. In order for the bag to work well it must be leak free. Every day you must do these two simple tests to make sure there are no leaks in the manual resuscitator bag.

### Test # 1

1. Wash hands well and put on gloves
2. Cover the outlet of the resuscitator bag with the palm of your gloved hand
3. With your other hand squeeze the resuscitator bag; you should feel the pressure in the bag against your hand
4. If you hear or feel a leak then tighten all the connections
5. After checking all the connections, test again for leaks by repeating steps 2 & 3. If it does not leak continue to *Test #2*
6. If it still leaks, you will have to replace your manual resuscitator bag. Call your respiratory home care professional

### Test # 2

1. Squeeze the resuscitator bag to empty it
2. Cover the outlet of the resuscitator bag with the palm of your gloved hand
3. Release the resuscitator bag while keeping the outlet covered with your gloved hand
4. The resuscitator bag should fill up freely. If it does not, then the inlet valve maybe sticking
5. If the bag does not refill, unscrew the inlet valve assembly (pieces 6, 7 and 8 in picture) and gently loosen the valve. Then put it back together
6. Do the test over again to make sure the resuscitator bag fills freely. If it still does not fill freely, you will have to get another manual resuscitator bag. Call your respiratory healthcare professionals



### How do I clean the Manual Resuscitator Bag?

1. Clean the bag at least once a month, or when it is dirty
2. Take apart all the pieces of the resuscitator bag
3. Fill sink/pail with warm soapy water
4. Put all the pieces in the soapy water making sure all pieces are covered for 20 minutes
5. Rinse the pieces well
6. Fill sink/pail with 1 part vinegar to 3 parts water. Soak for 20 minutes
7. Rinse well
8. Place on clean towel to dry
9. Reassemble pieces of resuscitator and do both the leak and pressure tests

The pieces go together in order from 1 to 8 from photo below.



**Figure 35: Manual Resuscitator Bag**

Photo Courtesy of Hamilton Health Sciences, used with permission of Laerdal Medical Canada Ltd [www.laerdal.ca](http://www.laerdal.ca)

**IMPORTANT! Anyone who needs a ventilator to breathe, will need a manual resuscitation bag. Those with a trach but do not need a ventilator to breathe, may also need a manual resuscitation bag.**

## Humidifiers

Humidification means to make moist or wet. Proper humidification helps keep the mucous thin and easy to cough up. There are two common types of humidifiers; the Heat and Moisture Exchanger (HME) and the pass-over humidifier.

### What is a Heat and Moisture Exchanger (HME)?

An HME is a filter-like sponge that is put onto the trach tube and stays there while the person breaths. It traps the heat and moisturize from the air that is breathed out from the lungs. On the next breath in, the air passes through the HME and becomes warm and moist.

HMEs are sometimes called an 'artificial nose'.

---

**IMPORTANT! Never dampen the HME with water.**

---

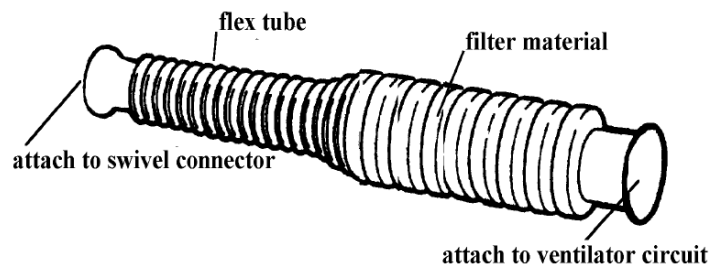

**HEAT & MOISTURE EXCHANGER**

**Figure 36: Illustration of an Heat Moist Exchanger**

Reproduced with permission from West Park Healthcare Centre Long-Term Ventilation Centre of Excellence.

### When do I need to change the HME?

Change the HME:

- ✓ Every day, if you are always using one
- ✓ Every second day, if you are using it only at night time
- ✓ When it becomes dirty

### What is a Pass-Over Humidifier?

Air from the ventilator passes over heated water, becoming warm and moist before going to the lungs.

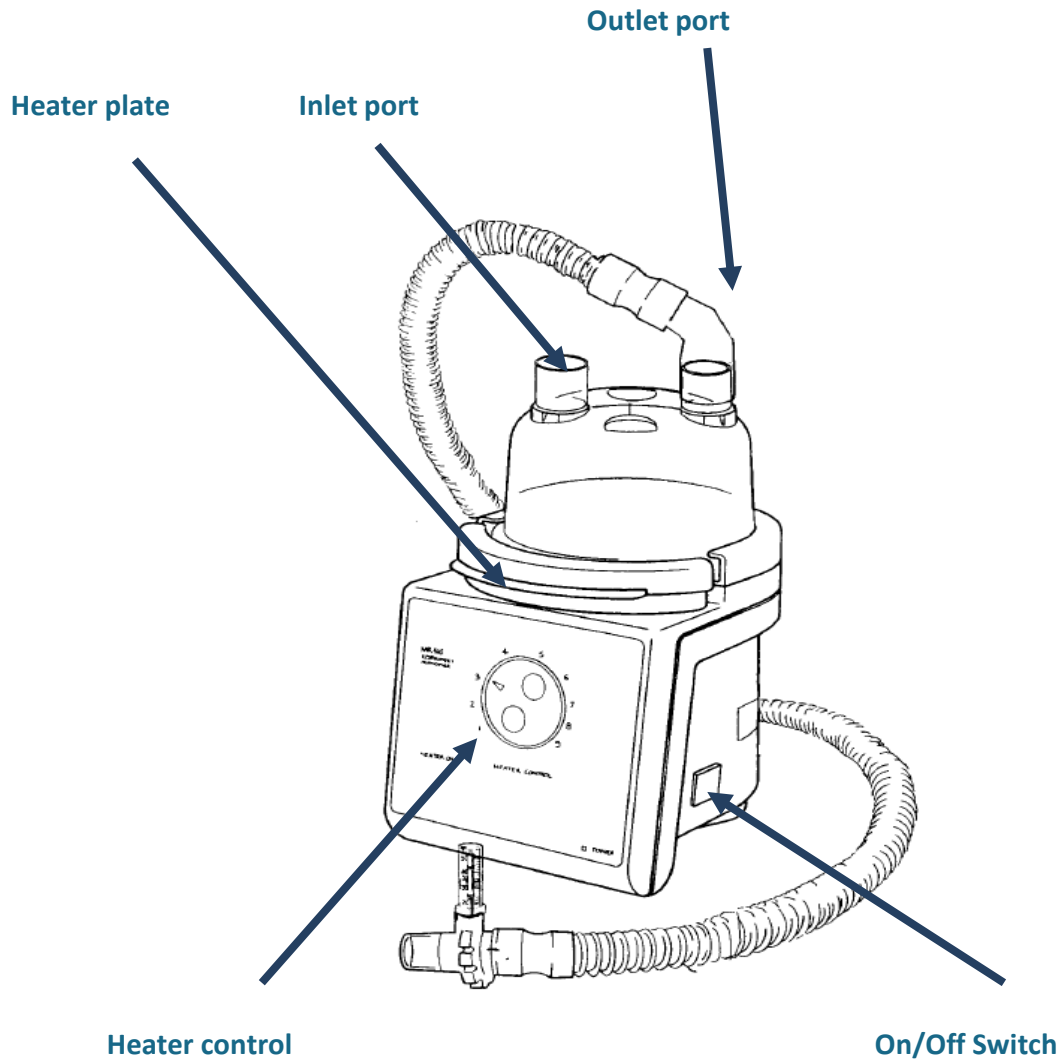

**Figure 37: Fisher Paykel MR 410 Humidifier**  
Reproduced with permission from Fisher & Paykel Health Care Inc

There are many types of pass-over humidifiers. All work in the same way, but the parts may look different. A common brand is The Fisher-Paykel humidifier. To learn more about how to care for your unit, read the user manual that comes with your equipment.

All units have:

- ✓ Three pronged wall plug for electricity
- ✓ Reservoir unit to hold the water
- ✓ Heater control that controls water temperature
- ✓ Heating plate that heats the water to the temperature that is dialled in

---

**IMPORTANT! Only use sterile distilled water. Sterile distilled water is very clean and free of germs.**

---

### Changing the Temperature

- ✓ The numbers on the heating control are “guides” for changing the temperature
- ✓ The temperature will depend on your comfort level and your healthcare professional’s instructions
- ✓ It takes a little time for the unit to warm up
- ✓ The water temperature can change depending on the room temperature, heaters, fans, or blankets

### How do I fill the reservoir unit with water?

The humidifier works best when you keep the water in the reservoir unit between the ‘refill’ and the ‘full’ line. Keep the water level in the reservoir at the highest water level mark.

Although the water between the lines will last for a number of hours, you will have to fill or refill the humidifier often. Once the level is at the low water level mark, throw out any water left in the reservoir.

Ensure that you change the water every day and that the humidifier is in a safe place so it will not get tipped over.

---

**IMPORTANT! Never drain water from the ventilator tubing back into the reservoir. Always drain the water from the ventilator tubing into a separate container.**

---

**If the ventilator is not in use:**

1. Wash your hands well
2. Use a funnel or a measuring cup
3. Disconnect the humidifier tubing and throw out the water
4. Rinse well and refill with sterile distilled water (Fill to the 'full line' marking)
5. Reconnect the circuit tubing to the reservoir port opening

**If you are using the ventilator:**

You will need to know how long the person can stay off the ventilator, while breathing on their own, before doing this next step. You will need to complete all the steps in the time they are off the ventilator and breathing on their own. Ensure you have a manual resuscitation bag on hand, in case they need to be given some breaths while off the ventilator.

1. Wash your hands well
2. You will need to change the circuit to 'go around' the humidifier. You can do this by following these steps:
  - ✓ Take off the short hose going to the humidifier from the ventilator outlet port
  - ✓ Separate the patient tubing from the humidifier port
  - ✓ Connect the patient tubing directly to the ventilator outlet port. Make sure there is no water in the circuit
3. Throw out any water that is in the reservoir unit and rinse well
4. Fill the reservoir unit by using a funnel or measuring cup and fill with sterile distilled water to the "fill line" marking
5. Disconnect the patient tubing from the ventilator outlet port and reconnect it to the humidifier port
6. Re-connect the short humidifier tubing to the ventilator outlet port

### There is water in the tubing, what should I do?

Sometimes when the air leaves the humidifier it cools in the tubing and water will collect in the ventilator tubing. Water in the circuit can:

- ✓ Cause problems ventilating the patient
- ✓ Cause germs to grow in the tubing which can lead to a lung infection

To remove the water from the circuit:

1. Wash your hands well.
2. If the circuit has a “water trap”, let the water inside the tubing run down into the water trap. Then empty the water trap collector. **Note: you do not have to unhook the ventilator circuit when emptying the “water trap” collector**
3. Disconnect the ventilator tubing from the patient at the trach site
4. Empty the short flex hose tubing by stretching it out and letting any water drain into a container
5. Remove the ventilator tubing from the humidifier outlet and drain it away from the exhalation valve
6. Drain the flex hose **away** from the exhalation manifold
7. Do not shake water from the tubing as it may spread germs
8. Attach the short flex hose to the patient's trach tube

## Inhaled Medicine

The use of inhalers or “puffers” is one way to give medicine. Often only a small amount is needed. Because the medicine is breathed into the lungs, it does not take long to work.

Puffers can be given to someone on a ventilator, by using a special chamber such as the AeroVent®.



**Figure 38: Puffer Canister and Aerovent Chamber**  
Reproduced with permission from Trudell Medical International

### How do I give a puffer to someone on a ventilator?

1. Make sure that you are using the most current puffer ordered by your doctor
2. Check the expiry dates
3. Check that there is medicine in the canister. Shake the canister slowly close to your ear to feel if it is full
4. Place the chamber into the inspiratory side of the ventilator circuit. If you have an HME on, take it off
5. Shake the canister 10 times
6. Attach the puffer canister to the chamber adaptor (AeroVent®)
7. Press down on the canister once, just as the patient begins to breathe in
8. Remove the canister. Replace the cap on the inlet port, to stop any leaks
9. Wait 30 seconds. If another puff is needed, repeat steps 5-8

Clean the chamber once a week, or when you clean the ventilator circuit. Also inspect the puffer adaptor for cracking and leaks.

## Other Issues

---

### Assistive Devices Program (ADP) Funding for Respiratory Supplies

#### How do I get funding for a ventilator and other supplies?

Anyone getting a ventilator and related supplies has to apply to ADP for funding assistance. While you are in the hospital getting ready to go home, you and your doctor will be asked to complete an ADP form to see if you qualify for funding.

To be approved for funding you must:

- ✓ Be an Ontario resident
- ✓ Have a valid Ontario Health Card
- ✓ Have a physical disability for at least 6 months
- ✓ Have the proper ADP forms completed by your doctor
  - A sample ADP form can be found in **Appendix A** in this Manual
  - The ADP forms need to be filled out every 3 years to renew the funding

The Assistive Device Program will pay for 100% of the cost of your ventilators and **some** of the accessories. ADP will pay 75% of the cost of your respiratory care supplies, such as:

- ✓ Custom-made masks
- ✓ Commercial masks
- ✓ Ventilator circuit supplies
- ✓ Suction units
- ✓ A manual resuscitation bag
- ✓ Disposable trach supplies

There is a limit on the amount of supplies that will be covered. To find out more about what is covered and what is not, you can read the ADP Respiratory Manual or talk to your respiratory therapist.

The Ventilator Equipment Pool (VEP) supplies your ventilator and ventilator circuits, battery, battery cable and humidifier. The VEP is located in Kingston Ontario. You will not need to go there to get your equipment. It will be sent to your home.



ADP is a part of the Ontario Ministry of Health & Long Term Care (MOHLTC) which is part of the Ontario government. Your ADP bill will be sent to the MOHLTC who will pay for your equipment. You will need to pay the remaining cost, which is 25% of the total for respiratory supplies.

### **What other funding sources are there?**

If you cannot afford to pay the remaining 25%, there are also some other options. Try the following agencies.

#### **Insurance Companies**

- ✓ Extended Health Care (EHC) Insurance through workplace or privately e.g. Ontario Blue Cross

#### **Government assistance programs**

- ✓ Ontario Disability Support Program (ODSP)
- ✓ Ontario Works
- ✓ Assistance for Children with Severe Disabilities (ACSD)

If you are interested in finding out more about other funding sources, contact your CCAC case worker, social worker or physician who will help you find out what is best for you.

## The Ventilator Equipment Pool

### What is the Ventilator Equipment Pool (VEP)?

The VEP is a central place where the ventilators are kept. VEP is part of Assistive Devices Program (ADP). The VEP supplies your ventilator and related equipment for those who are approved by ADP.

### Getting your Ventilator

Once ADP approves your request they inform VEP. VEP will then send you the equipment that your doctor has ordered.

### Ventilator Circuits

VEP will send you two ventilator circuits for every ventilator you are approved for. You will get 2 new circuits every 2 years.

### The equipment is to be returned to VEP if you:

- ✓ No longer need it
- ✓ Are not approved for funding
- ✓ Are admitted to hospital and are not coming home for quite a while
- ✓ Are living in Long Term Care

The VEP does not give ventilators for use in long term care facilities. Patients entering these facilities must tell VEP that their status has changed.

### Who will service and repair the ventilator?

The ventilator will need regular service. Service and repairs are done by the VEP at no cost to you. It is important to make sure that your ventilator receives the service when it should. Read the manual that came with the ventilator for more information.

VEP will **not** pay for equipment that is lost, stolen or damaged through neglect or abuse.

- ✓ When it is time for service, the VEP will call and to make arrangements to pick up the ventilator
- ✓ The replacement ventilator will be sent from Kingston and it will become your new ventilator. You will keep this 'new' ventilator until the next time your ventilator needs to be sent back for service

- ✓ Make sure the ventilator settings and alarm limits are set properly, before using the new ventilator

### I am having problems with my ventilator. Who do I call?

If you are having problems with your ventilator first look at the manual and the trouble shooting section in this book. **Your home care company may be able to help you to find out what the problem might be.** If you are still having problems with the ventilator, then contact your equipment provider.

Call your home care company if you have problems with your ventilator circuit, such as the tubing and connectors.

---

**IMPORTANT! Call your ventilator equipment provider if you are having trouble with your ventilator.**

---

#### My ventilator equipment provider is:

- VEP

VEP phone number is **1-800-633-8977** or **1-613-548-6156**.  
Follow the prompts on the message for service after business hours. A respiratory therapist is available 24 hours a day.

- My ventilator supply provider's name is:

\_\_\_\_\_

Phone number is: \_\_\_\_\_

## References

---

Department of Critical Care Nursing. (2002). *Passy-Muir® tracheostomy speaking valve*. Ohio: The Ohio State University Medical Center.

Department of Critical Care Nursing. (2007). *Tracheostomy suctioning*. Ohio: The Ohio State University Medical Center.

Department of Inpatient Nursing. (2005). *Changing tracheostomy ties*. Ohio: The Ohio State University Medical Center.

Department of Inpatient Nursing. (2005). *Reinsertion of a tracheostomy tube*. Ohio: The Ohio State University Medical Center.

Department of Inpatient Nursing. (2005). *Tracheostomy care. Disposable inner cannula*. Ohio: The Ohio State University Medical Center.

Department of Inpatient Nursing. (2005). *Tracheostomy tubes*. Ohio: The Ohio State University Medical Center.

Department of Inpatient Nursing. (2007). *Tracheostomy care with non-disposable inner cannula*. Ohio: The Ohio State University Medical Center.

Division of Nursing: The James Cancer Hospital and Solove Research Institute. (2004). *Tracheostomy cuffs*. Ohio: The Ohio State University Medical Center.





College of  
Respiratory Therapists  
of Ontario

# Non-Invasive Positive Pressure Ventilation



(for Adults)

**This booklet has been developed by**

Kingston General Hospital Staff

Including:

Layout and Design: F. Toop RPSGT

Illustrations: K. Thibault RPSGT

**Contributors**

L. Anderson RPSGT, E. Crochrane RRT RPSGT B.Comm,

L. Danahy RT RPSGT, C. Dawson BA Honours RPSGT,

H. Driver PhD RPSGT D.ABSM,

N. Farr RPSGT, Dr. M. Fitzpatrick M.D. FRCPC D.ABSM

S. Fodey RRT, A. Leach RRT, Dr. P. Munt M.D. FRCPC,

C. Phillips MSc RRT, C. Pugh RRT, K. Thibault RPSGT, F. Toop RPSGT

Copyright© 2008, Kingston General Hospital

All rights reserved.

Edited by Rosanne Leddy RRT

**Reproduced with permission from Kingston General Hospital.**

## Table of Contents

---

Funding Coverage .....	1
Getting Started .....	2
Living With Bi-Level.....	4
Bi-Level Units .....	5
Cleaning.....	9
Troubleshooting.....	12
Contact Information.....	16

## Funding Coverage

---

**The Assistive Devices Program (ADP) funds the Ventilator Equipment Pool (VEP). Equipment from the VEP is provided free-of-charge to you on a loan basis for as long as it is required.**

The ADP will help cover some of the cost of the mask, headgear, tubing, and filters required. For example, ADP will currently contribute to a maximum of 75% of \$350.00 toward the purchase of a mask. ADP will also contribute funding towards consumable supplies such as a non-invasive circuit (tubing and filters), and provide up to 3 masks over a claim period. Your healthcare provider will discuss this with you. Once you have been approved by ADP you will become a client of the VEP. You may have additional financial assistance through your insurance company. You may be entitled to social assistance benefits such as Ontario Works (OW), Ontario Disability Support Program (ODSP), or Assistance to Children with Severe Disabilities (ACSD).

The application process for the Bi-Level unit generally takes 6-8 weeks. Under special circumstances some people may receive a machine on loan or as a rental before they have been officially approved. Once you have been approved, you will then become a client of the VEP. This means that you will be loaned a Bi-Level unit for as long as you require it. Once you no longer need the unit, it should be returned to the VEP.

### Contact VEP:

<http://www.ontvep.ca>

**1-800-633-8977 (Toll free in Ontario)**

**or (613) 548 6156**



## Getting Started

---

Bi-Level machines consist of inspiratory and expiratory pressures. Your unit will also have a back-up rate, which ensures a minimum number of breaths are provided each minute. Some patients with respiratory disorders may show a breathing pattern of small lung volumes and increased breath rates. This can cause a decrease in the amount of oxygen in your blood, and an increase in the carbon dioxide levels. When the Bi-Level unit is set correctly, lung volumes and breath rates return to acceptable values, resulting in more normal breathing patterns. This in turn will help improve your levels of oxygen and carbon dioxide.

These machines are loaned free of charge, to clients approved by the ADP through the Ontario ministry of Health & Long Term care. In order to qualify for funding you must meet the following criteria:

1. Must be an Ontario resident with a valid Ontario Health Card
2. You must reside in either the community or a group home setting where the facility is your long-term residence

You are not eligible if you meet one of the following:

1. If you live in an acute or chronic care hospital
2. If you reside in a Long Term Care Facility
3. You are eligible to receive benefits from the Worker's Compensation Board (WCB) or Veteran's Affairs (DVA) Group A. Check with DVA as they may only fund certain situations. This may avoid wasted time and longer application wait time due to eligibility criteria

The VEP was developed in order to provide a cost-effective way of allowing patients to return home with respiratory equipment to assist with their breathing.

Although this machine will help your breathing, it is **not intended for life support**. You have or will be given 2 ADP/Equipment Supply Authorization (ESA) forms to sign along with instructions. One of these forms will be sent to Toronto with a letter from the doctor concerning your diagnosis and the need for this type of machine. **The second form is for you to take to the homecare vendor of your choice for the purchase of masks, headgear, filters, tubing etc.** This form is valid for 3 years and after that time a new ADP form will be filled in. The client may purchase any quantity of masks to a maximum of three in the three year claim

period. For example, clients may choose to purchase two masks up front and then purchase the third mask in year two or year three. Often having a spare mask is a good idea although purchasing all three at once is discouraged in case there is a weight loss requiring a new mask during the claim period.

Numerous styles of masks are available from these vendors. You will want to ensure that you are comfortable with the mask you will be wearing on a nightly basis. Choose a vendor who will be willing to try different masks with you and who is helpful in teaching you how to apply and clean them.

# Living With Bi-Level

---

In this section we will go over some basic information about:

- ✓ Some ways you can help yourself get used to using Bi-Level
- ✓ How to fix basic problems that people often have with Bi-Level

## Getting used to Bi-Level

It may take a little time to get used to wearing Bi-level. If so there are strategies that you can use to help yourself to get used to wearing it. **The risk can be life threatening so make every effort to become comfortable with Bi-Level ventilation.**

Discuss with your physician different scenarios that may lead to the inability to use the bi-level device . Ask what is a safe e.g. “Can I sleep a night without it?” Also ask about different situations such as power failure, blocked nose, equipment failure, away from home and cannot return home.

## Set-up

Place the Bi-Level next to your bed at the same height as or below your head. It should not be placed on the floor or over the head of the bed.

## Bi-Level Units

---

Here are some examples of Bi –Level devices

### TYPE #1



Figure 1: ©ResMed 2006.  
Reproduced with permission.

If you have this Bi-Level unit please put on your mask and have it connected BEFORE you turn on the machine.

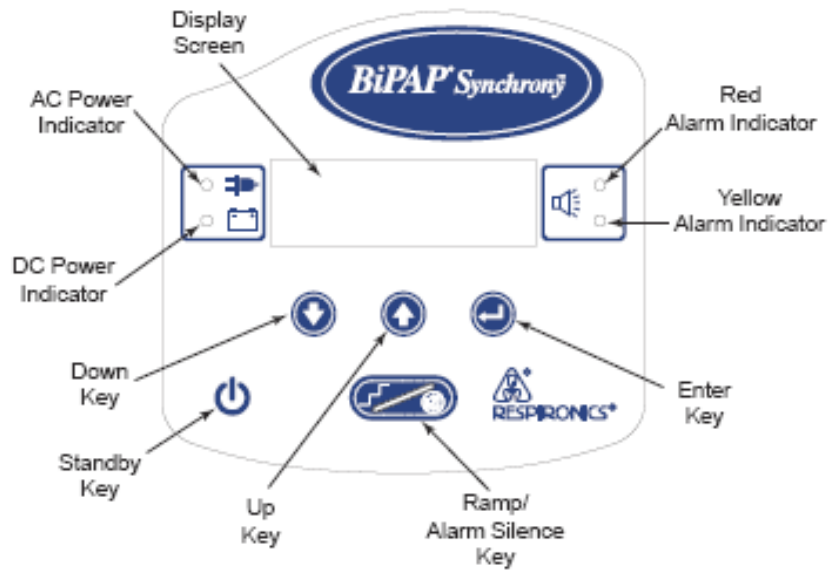

Figure 2: ©ResMed 2006.  
Reproduced with permission.

## Type #2



**Figure 3: Synchrony®**  
©Respiroics Inc. Murrysville, PA.  
Reproduced with permission.



**Figure 4: Detail of the Synchrony® Control Panel.**  
©Respiroics Inc., Murrysville, PA.  
Reproduced with permission.

## Masks

Finding a mask that fits you well is one of the most important steps in getting used to Bi-Level. Don't get discouraged if the first mask you try isn't comfortable after a night or two. Most vendors will allow you to trial masks. The number of masks that they will let you try and the length of the trials vary by vendor. Mask trials can save you from buying something that doesn't work for you.

Poorly fitting masks lead to discomfort and often to not wearing your Bi-Level. Leaking masks or severe mouth leak can decrease the effectiveness of the therapy, making it harder to get used to. Masks that are a good fit improve the effectiveness of the therapy.

**Speak to your physician about the serious health implications of not wearing your Bi-Level mask.**

Some people find it helpful to use more than one kind of mask. Your face changes shape slightly each day, and you may find that some days your mask just doesn't fit perfectly. If you have another mask it might work better for you on those days. This doesn't mean that you have to go out and purchase two masks right from the start, but if you are having a lot of difficulty finding a mask that will work well for you all of the time it may be worth considering.

### There are four basic types of masks:

**Nasal Masks** cover only your nose. They are usually the least expensive masks and work well for most people. If you have any trouble breathing through your nose only, this may not be the mask for you. Every time that you open your mouth with a nasal mask the pressure that is holding your airway open escapes. This means you will not get the full benefit of wearing Bi-Level. A sign that you are not breathing through your nose is when you wake up with a very dry mouth. Sometimes increasing the humidity setting will help. If the problem continues then using a chinstrap (see next page) may help. The next step would be to move to a full face mask.

**Full Face Masks** cover both your nose and mouth. They are usually more expensive than nasal masks. They work very well if you breathe through your mouth. Some people find them more comfortable. Typically there will be more problems with air leaking around the mask than with a nasal mask because it will shift any time that you move your jaw. If there is a reason that you can't breathe through your nose (like congestion or a broken nose) a full face mask may be a good option for you. If you would really like to use a nasal mask you should speak with your doctor to see if something can be done to help you

breathe through your nose. It is important that you continue to use Bi-Level while these steps are taken, so a full face mask may be necessary while you and your doctor work toward a solution.

**Nasal Pillows** are becoming quite popular and there are several different brands available. They fit against or inside your nostrils. Since they put less pressure around your nose than nasal masks they can be more comfortable. As with the nasal mask you need to be able to breathe through your nose. Sometimes they can cause irritation in your nostril. This can be from having the wrong size cushion (or pillow) for you nostril. If the pillow is too large it can put pressure against the inside of your nostril and make it sore. If the pillow is too small then air can leak around it and cause dryness and a burning sensation. They are generally more expensive than nasal masks.

**Oral Masks** are probably the least popular of all the masks. They do work well for a very select group of people. They require you to breathe only through your mouth. They fit into your mouth like a mouthpiece for scuba diving. The most common complaints are pressure on the gums and oral dryness. Air may leak out the nostrils and this may require a method to plug the nose to stop nasal leak.

### Chin Straps

Chin straps can help you wear a mask more effectively. If you find that you are opening your mouth when using a nasal mask you can try wearing a chinstrap. Sometimes people find it helpful to wear one along with their full face mask to keep their jaw from opening wide enough to push the mask off. The chinstrap fits around your head and under your jaw to help keep your jaw from falling open in your sleep. There are several types available from vendors or you can make one yourself.

# Cleaning

---

If you don't clean your Bi-Level system it can lead to many problems. Masks that are not cleaned can lead to sores on your face, and may not seal against air leaks. They do not last as long because the oils from your skin can cause the plastic to break down more quickly. Tubing that is not cleaned can gather dust and sometimes even mold. Filters are made for trapping dust but must be cleaned or replaced to prevent the dust from getting into your tubing. Headgear sits against your hair and skin; like any clothing it will last longer if it is washed regularly. The humidification chamber provides the perfect warm moist place for mold and bacteria to grow and should be rinsed and dried after use. All this can increase the chance of infection.

---

**IMPORTANT! Do not use bleach, chlorine, alcohol or antibacterial products.**

---

## You will need:

- ✓ Mild liquid dish soap, unscented with no antibacterial component
- ✓ Distilled water, which has been boiled for five minutes for use in the heated humidifier
- ✓ Clean sink
- ✓ Somewhere you can hang the tubing to air dry - example: towel rail, shower
- ✓ Please check the manufacturer's specifications as the instructions and recommendations for Bi-Level units, mask cleaning and disinfecting (including the humidification chamber) vary (refer to the user's manual)

## How to clean your mask or nasal pillows:

- ✓ Remove headgear from the mask
- ✓ Gently wash the mask in warm water, mixed with dish soap
- ✓ Rinse thoroughly with warm water
- ✓ Shake mask to remove excess water or wipe gently with a soft cloth
- ✓ Let it air dry for the rest of the day
- ✓ For daily cleaning, specially designed wipes are available. Ask your vendor if available to use with your style of mask or nasal pillows

---

**IMPORTANT! Clean your mask or nasal pillows every day.**

---



### How to clean your headgear:

- ✓ Hand-wash with soap and water, or put it into the washing machine on the cold setting
- ✓ Air drying will extend the life of the headgear

---

**IMPORTANT! Clean your headgear once a week.**

**Do not use heat to dry the headgear. It will shrink the cloth and ruin the Velcro®.**

---

### How to clean your tubing:

- ✓ Remove tubing from machine
- ✓ Place in sink of warm soapy water
- ✓ Place one end of the tubing under the tap and rinse until the water is clear
- ✓ Shake off excess water
- ✓ Hang to air dry (e.g. shower, back of chair) before reconnecting to your Bi-Level unit

---

**IMPORTANT! Clean your tubing at least once a week.**

---

### How to dust your Bi-Level machine:

- ✓ Wipe off the exterior of the Bi-Level machine with a damp cloth
- ✓ Keep the back of the machine clear from dust by cleaning off dust from tabletop

---

**IMPORTANT! Dust your Bi-Level machine and table once a week.**

---

### How to clean your filters:

Rinse-able – once a week (usually black or gray)

- ✓ Remove filter from Bi-Level unit
- ✓ Rinse in warm water (no soap)
- ✓ Gently squeeze out excess water
- ✓ Leave to air dry before replacing

Disposable – monthly (usually white)

- ✓ Check filter weekly
- ✓ Replace every 4 weeks/monthly
- ✓ If blocked by dirt, replace. (It will look grey or brown)

---

**IMPORTANT! Clean your filters regularly**

---

#### How to clean your humidifier:

- ✓ Wash daily
- ✓ Warning: The water and heater plate may be hot
- ✓ Discard excess water
- ✓ Some chambers can be washed in the dishwasher. Consult the manufacturer's manual for instructions
- ✓ Rinse thoroughly with water and air dry
- ✓ Make sure that the docking station or hot plate is dry before replacing the chamber
- ✓ **Use only distilled water that has been boiled and cooled prior to use in the humidifier in the humidifier**

---

**IMPORTANT! Check the manufacturer's specifications as the instructions and recommendations for cleaning and disinfecting the humidification chambers may vary.**

---

---

**IMPORTANT! Clean your humidifier at least once a week**

---

It might be helpful to draw up a cleaning schedule to help you remember when each piece of equipment should be cleaned.

When you first start using your Bi-Level the cleaning can seem a little overwhelming. Your investment of time is well spent in improving your health.

# Troubleshooting

---

## Why does it feel hard to breathe out? Will anything make it easier?

- Remember that it is normal to feel uncomfortable at first. Since you are breathing out against a pressure, it will feel more difficult. Relax and take slow deep breaths

## My eyes are red and sore in the morning or wake me up because they hurt.

### What should I do?

- This can be caused by air leaking around the mask and into your eyes. You should solve this problem quickly to avoid further injury to your eyes
- Start by reapplying the mask and adjusting the straps on the headgear. If you have an adjustable forehead rest on your mask adjust it until the air is not leaking into your eyes (usually moving the button down toward your chin or by turning the adjustable device clockwise)
- Make sure not to over-tighten your mask. If your mask is pressing hard on the skin by your eyes it can also make your eyes sore
- If these steps do not solve your problem then try some different masks. You will need to call your vendor to discuss your options

## My face is red where the mask touches it. What should I do?

- Try loosening your mask. As long as it is not leaking severely, or leaking into your eyes there isn't a need to have it really tight. In fact over-tightening your mask can cause it to leak more
- Try a different mask. Not all masks are the same shape so a different one may not irritate your skin or put pressure in the same places. You will need to call your vendor to discuss your options
- Because a mask is pushing against your skin it can cause irritation. Sometimes using a barrier or cushioning the bridge of the nose with a product like moleskin can help. Ask your vendor about these products
- It is also possible that you are allergic to the mask material or the cleaning agent
- Please be certain that whatever soap you are using is not anti-bacterial. Try using a hypoallergenic soap

### Why is my nose runny when I put on my Bi-Level?

- This is a reaction to the airflow of Bi-Level. Start by increasing the setting of your heated humidifier. Moist air shouldn't irritate your nose as much. If this does not work then please book an appointment to see your doctor. It is possible that you will need to use nasal medication

### Why is my nose stuffy when I put on my Bi-Level?

- The first things to check are the filters in the back of your Bi-Level machine. If they are clogged with dust then it is likely dust is being blown through your Bi-Level unit and into your mask. This not only makes your nose stuffy but is hard on the motor of your Bi-Level unit and it may wear out faster
- This can be another reaction to the airflow of Bi-Level. Adjust your heated humidifier to a higher setting. As long as water is not collecting in your tubing it is OK to turn up the heater. If the stuffy nose lasts more than a week, consult your doctor
- You have a cold
- If you have a cold and just can't breathe through your nose you may need to discontinue use of Bi-Level until your cold is gone, but CONSULT YOUR DOCTOR FIRST. Always discuss missing treatment scenarios with your physician

### It feels like the machine is puffing the air faster than I am breathing. What should I do?

- Try just relaxing and see if you can get used to this different way of breathing
- If your breathing rate was fast when you first started therapy, it may slow down with using Bi-Level. A normal breathing rate is 10 to 12 breaths per minute
- Call the VEP or your vendor to explain your problems. They will work with you to find a solution that will help you be more comfortable on Bi-Level therapy

### My nose is dry and burning inside. What can I do?

- Use a heated humidifier. If you are already using one then adjust it to a higher setting
- If you use nasal pillows talk with your vendor to make sure you have the proper size
- Air leaking out around the edges of your nostrils can dry out your nostrils and make it uncomfortable to wear your Bi-Level
- Bi-Level units have heated humidifiers that make the air you breathe more moist. You should adjust the setting on the heater plate to a level that is comfortable

**My throat is dry when I wake up. What can I do?**

- The unit will blow more air to try and make up for air leaking out the mouth. Try using a chinstrap or a Full Face Mask. Your vendor should be able to help you

**My ears hurt or feel like they need to pop. Why?**

- It can be normal for your ears to feel like they need to pop when you first wear Bi-Level. When the Bi-Level air under pressure enters the nose (or mouth) it hits the back of your throat on its way to the trachea and lungs. The pressurized air can enter the Eustachian tube(s) and give a sense of pressure in the ear. Sometimes increasing your heated humidity setting will help. If you have a cold, post nasal drainage, sinusitis, sore throat, or allergies you can also get inflammation and a little swelling in the back of your throat, that will aggravate the problem, and sometimes bacteria from the throat can cause an infection. If your ears hurt (and don't just pop) please contact your physician

**My sinuses hurt when I put on Bi-Level. What can I do?**

- Try increasing your heated humidity setting, but since pain in your sinuses can be a sign of a sinus infection you should contact your family doctor

**I turned up my heated humidifier and now get woken up by a popping or thumping sound from my tubing. What can I do?**

- The sound is caused by water collecting in the tubing. This can happen because the air around the tubing cools the warm, moist air as it leaves the heated humidifier. Cooler air cannot hold as much moisture so some of the water drops out into your tubing. Make sure there is no air blowing on the tubing such as from a fan or open window. This will cool the tubing and cause more water to develop in the hose. You may try to keep the hose under the sheets if possible. You should call the VEP for possible solutions to this problem
- Empty the water from the tubing . Do not attempt to empty the water back into the humidifier. To decrease the amount of rainout, try using a rainout reduction kit. These are available from your equipment provider

**I push the power button and nothing happens. What should I do?**

- Make sure the power cord is plugged into the wall, the power adapter (if your unit has one), and at the back of the unit
- Make sure that the outlet you used is providing power. Plug something else into it, like a lamp
- Try unplugging it for a few minutes and then plugging it back in. Sometimes after a drop or surge in the power lines the units need to reset

---

**IMPORTANT! If these steps don't work then you will need to contact the Ventilator Equipment Pool or your equipment provider.**

---

## Contact Information

---

Questions concerning your treatment should be directed to:

Your equipment provider for equipment concerns: \_\_\_\_\_

Your health professional/doctor for concerns about your medical condition: \_\_\_\_\_  
\_\_\_\_\_

You respiratory vendor for supplies/oxygen: \_\_\_\_\_

Questions regarding your application can be directed to: \_\_\_\_\_ ext. \_\_\_\_\_

**Equipment issues should be brought to the attention of  
the Ventilator Equipment Pool at (613) 548-6156 or 1-800-633-8977.**

**Questions regarding your application can be directed to  
the Ventilator Equipment Pool at (613) 548-6156 or 1-800-633-8977.**

Date: \_\_\_\_\_

Your current mask: \_\_\_\_\_

Your current Bi-Level settings:

IPAP: \_\_\_\_\_ cmH<sub>2</sub>O

EPAP: \_\_\_\_\_ cmH<sub>2</sub>O

Rate: \_\_\_\_\_ breaths per minute



College of  
Respiratory Therapists  
of Ontario

# Home Ventilation & Tracheostomy Care



Teaching Manual for Paediatrics





# Table of Contents

---

<b>Introduction</b> .....	<b>1</b>
<b>The Normal Respiratory System</b> .....	<b>2</b>
What does the Respiratory System do? .....	6
<b>Preventing Infection</b> .....	<b>7</b>
What can I do to Prevent Infections? .....	7
What is Pneumonia? .....	8
What are the signs of an infection? .....	8
What should I do if my child has an infection? .....	8
Washing Your Hands at Home .....	9
Sterilizing Distilled Water.....	10
<b>Tracheostomy Care</b> .....	<b>11</b>
What is a Tracheostomy?.....	11
Going Home with a Trach .....	12
Description of Tracheostomy (Trach) Tubes.....	13
Types of Trach Tubes .....	16
Stoma Care.....	19
Trach Tube Care .....	21
Other Information About Trach Tubes .....	25
Speaking Valves.....	28
Trach Kit .....	32
Tracheal Suctioning.....	32
Changing the Trach Tube .....	37
<b>Mechanical Ventilation</b> .....	<b>40</b>
What is Mechanical Ventilation? .....	40
Why is Mechanical Ventilation Needed? .....	40
Ventilator Settings .....	41
Modes of Ventilation .....	41
Ventilator Rate .....	42
Ventilator Power Sources .....	44
The Ventilator Circuit.....	49
Ventilator Safety and Trouble Shooting.....	53

<b>Other Equipment .....</b>	<b>56</b>
Using and Cleaning the Portable Suction Unit.....	56
The Manual Resuscitation Bag.....	58
Humidifiers.....	62
Inhaled Medicine .....	67
<b>Other Issues.....</b>	<b>68</b>
Assistive Devices Program (ADP) Funding for Respiratory Supplies.....	68
The Ventilator Equipment Pool.....	70
<b>References .....</b>	<b>72</b>

## Introduction

---

This Manual has been written to help you learn how to care for your child's tracheostomy. It will be used to provide instructions on the basic care of a tracheostomy tube and will be yours to keep as a reference guide. This Manual will give you some instruction on how to suction, change the trach ties, and some general safety guidelines. This book is only a guide. If you have any questions, ask any of your healthcare team professionals.

**Important terms are used in this manual. Please refer to the Glossary of Terms for a complete list of definitions. A troubleshooting section is also available.**

# The Normal Respiratory System

The respiratory system is made up of the:

## Upper Respiratory Tract

- ✓ Nose
- ✓ Mouth
- ✓ Larynx (voice box)

## Lower Respiratory Tract

- ✓ Trachea (windpipe)
- ✓ Right and Left Lung
- ✓ Airways (bronchi)
- ✓ Alveoli (air sacs)
- ✓ Capillaries

## Respiratory Muscles

- ✓ Diaphragm (largest muscle)
- ✓ Intercostals (rib cage muscles)
- ✓ Abdominal Muscles

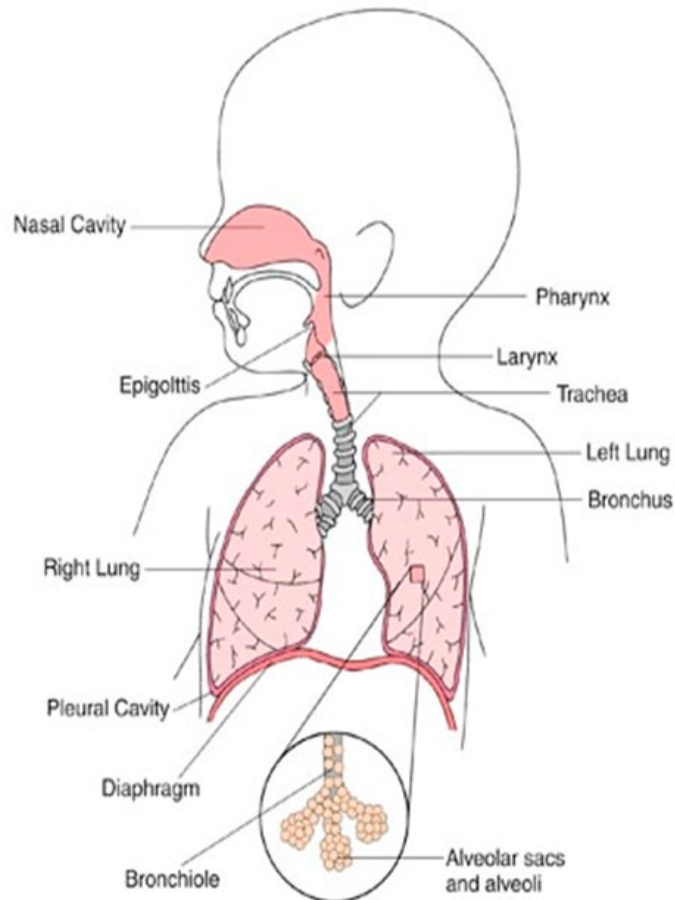

**Figure 1: Respiratory System**

Illustration used with permission from Hamilton Health Sciences

The **nose** is the best way for outside air to enter the lungs. In the nose the air is cleaned, warmed and moistened. There are hairs lining the inside of the nose that filter the air.

When you breathe through your **mouth** you are not filtering the air, but it will be warm and moist. When you have a cold and your nose is blocked you may not be able to breathe through your nose.

The **larynx** (voice box) contains the vocal cords. This is the place where air, when breathed in and out, creates voice sounds. It is also used to build up pressure for a strong cough.



**Figure 2: Larynx**

Reproduced with permission from Ottawa Rehabilitation Centre

The **epiglottis** is a flap of tissue that hangs over the larynx (voice box). When you swallow food or drink this flap covers the voice box and windpipe so you do not choke.

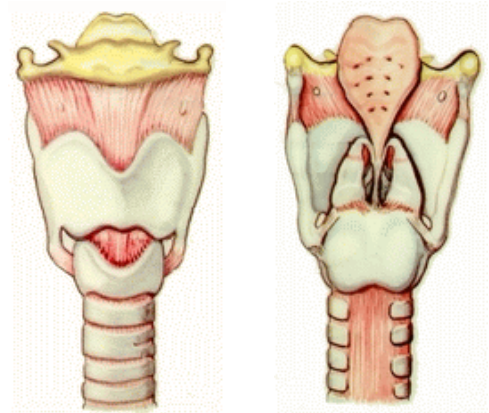

**Figures 3 & 4: Epiglottis**

Reproduced with permission from Ottawa Rehabilitation Centre

The **trachea** (wind pipe) is the tube leading from the voice box to the lungs.

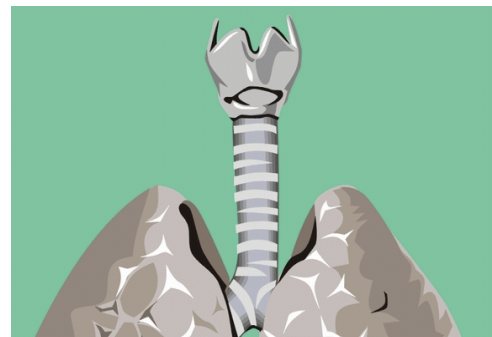

**Figure 5: Trachea**

Reproduced with permission from Ottawa Rehabilitation Centre

The **bronchi** are tubes that let air in and out of the lungs. The bronchi lead to tiny air sacs called the **alveoli**.

**Mucous** is made in the smaller tubes. The mucous traps dust, germs and other unwanted matter that has been breathed into the lungs.

Tiny hairs called **cilia** move back and forth moving the mucous up toward the throat where it can be coughed out or swallowed.

Infants and small children make more mucous than adults. They often have a harder time getting rid of the mucous. Mucous tends to build up and block the nose making it hard to breathe.

The **capillaries** are blood vessels that are in the walls of the alveoli (air sacs). Blood flows through the capillaries, removing carbon dioxide from the air sacs and picking up oxygen.

The **ribs** are bones that support and protect the chest cavity. They move up and out, helping the lungs expand and contract.

Infants and children have weak bucket-handle shaped ribs. This translates into inefficient rib action and lower volumes taken into the lungs.

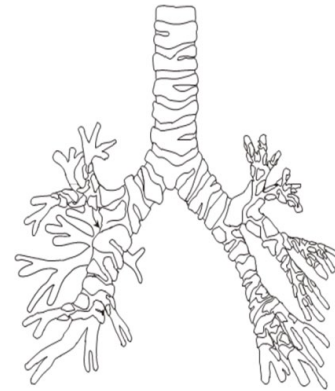

**Figure 6: Bronchi**

Reproduced with permission from Ottawa Rehabilitation Centre

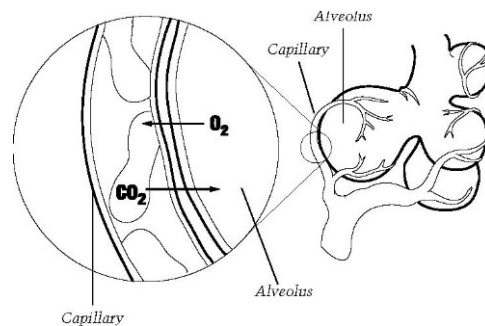

**Figure 7: Capillaries and Aveoli**

Diagram courtesy of SIMS Portex Inc Tracheostomy Care Handbook 1998  
Reproduced with permission  
<http://www.tracheostomy.com/resources/pdf/TrachHandbk.pdf>

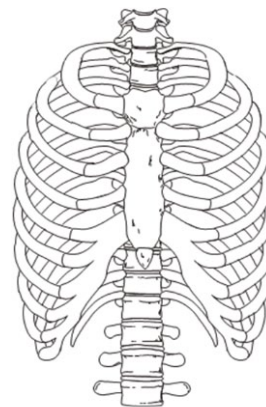

**Figure 8: Rib Cage**

Reproduced with permission from Ottawa Rehabilitation Centre

The **diaphragm** is a large strong muscle that separates the lungs from the belly. When the diaphragm contracts it moves downward, creating a suction effect, drawing air into the lungs.

Infants and children have diaphragms that are higher than in adults. This means they have to work a little harder to breathe in than adults do.

The **intercostals** are the muscles in-between the ribs. There are two types of intercostals muscles.

The **external intercostals** help you take deep breaths in, such as when you prepare to cough.

The **internal intercostals** help you forcefully breathe out, such as when you cough or sneeze.

The **abdominal muscles** help create a good strong cough.

Infants and children have a large tummies compared to their size. This places extra pressure on the chest and gets in the way with how the lungs expand.

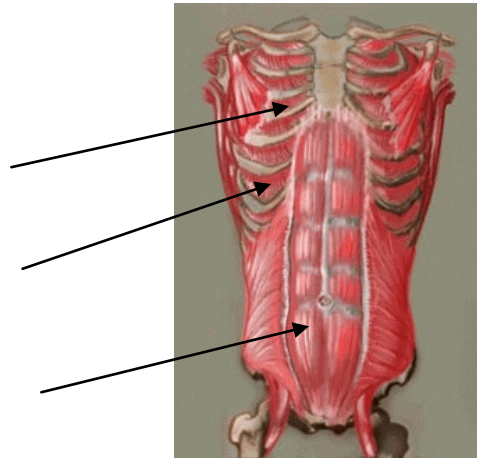

**Figure 9: Intercostal and Abdominal Muscles**  
Reproduced with permission from Ottawa Rehabilitation Centre



## What does the Respiratory System do?

### Breathing In

When you breathe in a large muscle called the diaphragm contracts causing air to be sucked into the lungs. The air that is carried into the lungs contains oxygen that your body needs to survive.

When you breathe in, the diaphragm moves down and the ribs move out and up. This causes a suction effect that lets air come into the lungs. The air comes into the nose where it is warmed, filtered and moistened. The air then goes down the windpipe past the voice box. From there it moves into two large main branches of the lungs called the left and right bronchi. The air moves through airways that get smaller and smaller until they reach tiny air sacs. These air sacs let oxygen into the capillaries. The blood flows from these capillaries to the heart where it is pumped out to the body.

### Breathing Out

When you breathe out the lungs remove carbon dioxide, a gas that your body does not need.

Just before you begin to breathe out the carbon dioxide goes across from the capillaries into the air sacs. The air sacs begin to relax and the air begins to move out of the lungs. Then the diaphragm and the muscles between the ribs also relax. This causes the ribs to gently fall, helping to push the air out from the lungs. Under normal conditions, the diaphragm and rib cage muscles are relaxed when you breathe out. However, when you cough or sneeze, these muscles work hard to push the air out quickly.

Normally breathing takes place without any thought. Some conditions can cause breathing problems. Every condition is different. So talk to your healthcare professionals about how your child's condition affects their breathing.

# Preventing Infection

---

## What can I do to Prevent Infections?

Keep Things Clean!

### Hands

- ✓ Insist that everyone wash their hands, often
- ✓ Buy hand sanitizers for your home

### Air

- ✓ Make your home smoke free. Insist that no one smoke around you
- ✓ Tell friends and family to stay away if they have a cold or the flu. If they need to be near you and your child they **must** wear a mask and wash their hands often

### Trach

- ✓ Follow trach care instructions carefully. Clean trach tubes
- ✓ Keep the trach dressings and the stoma (opening) clean and dry

### Equipment

- ✓ Clean equipment regularly, such as ventilator tubing and suction equipment
- ✓ Replace equipment on a regular schedule. Ask your healthcare professional when supplies are to be thrown out

---

**IMPORTANT! It is very important that *everyone* wash their hands. Wash your hands before and after doing anything with the trach tube or the stoma.**

---

## What is Pneumonia?

It is important to protect the lung from viruses and germs. If the air your child breathes is clean and moist, it will stop an infection from happening.

Breathing in dry, dirty air can cause germs and viruses to get into the lung, which can lead to pneumonia. Pneumonia is a lung infection where the airways swell and more mucous than normal, is made. Pneumonia can lower the amount of air getting into the lungs. It can also lower the amount of oxygen getting into the blood.

---

**IMPORTANT! Wash your hands before and after doing anything with the tracheostomy.**

---

## What are the signs of an infection?

If your child has any of these signs, it may mean they have an infection.

Your child is:

- ✓ coughing more
- ✓ has a fever or the chills
- ✓ feels unwell or are really tired
- ✓ is more short of breath
- ✓ is having chest tightness

Your child's mucous:

- ✓ is thick and/or there is more of it
- ✓ is yellow or green
- ✓ has an unpleasant smell

Your child needs:

- ✓ to be suctioned more often
- ✓ to take puffers more often

Your child's ventilator:

- ✓ has higher than normal pressures

Your child's stoma:

- ✓ is red, swollen or is painful

## What should I do if my child has an infection?

- ✓ Call your doctor or healthcare professional if think your child has an infection
- ✓ Follow your doctor's orders on giving your child medicine, such as antibiotics
- ✓ If you have an action plan, go over it with your healthcare professional. Do not be afraid to ask for advice

## Washing Your Hands at Home

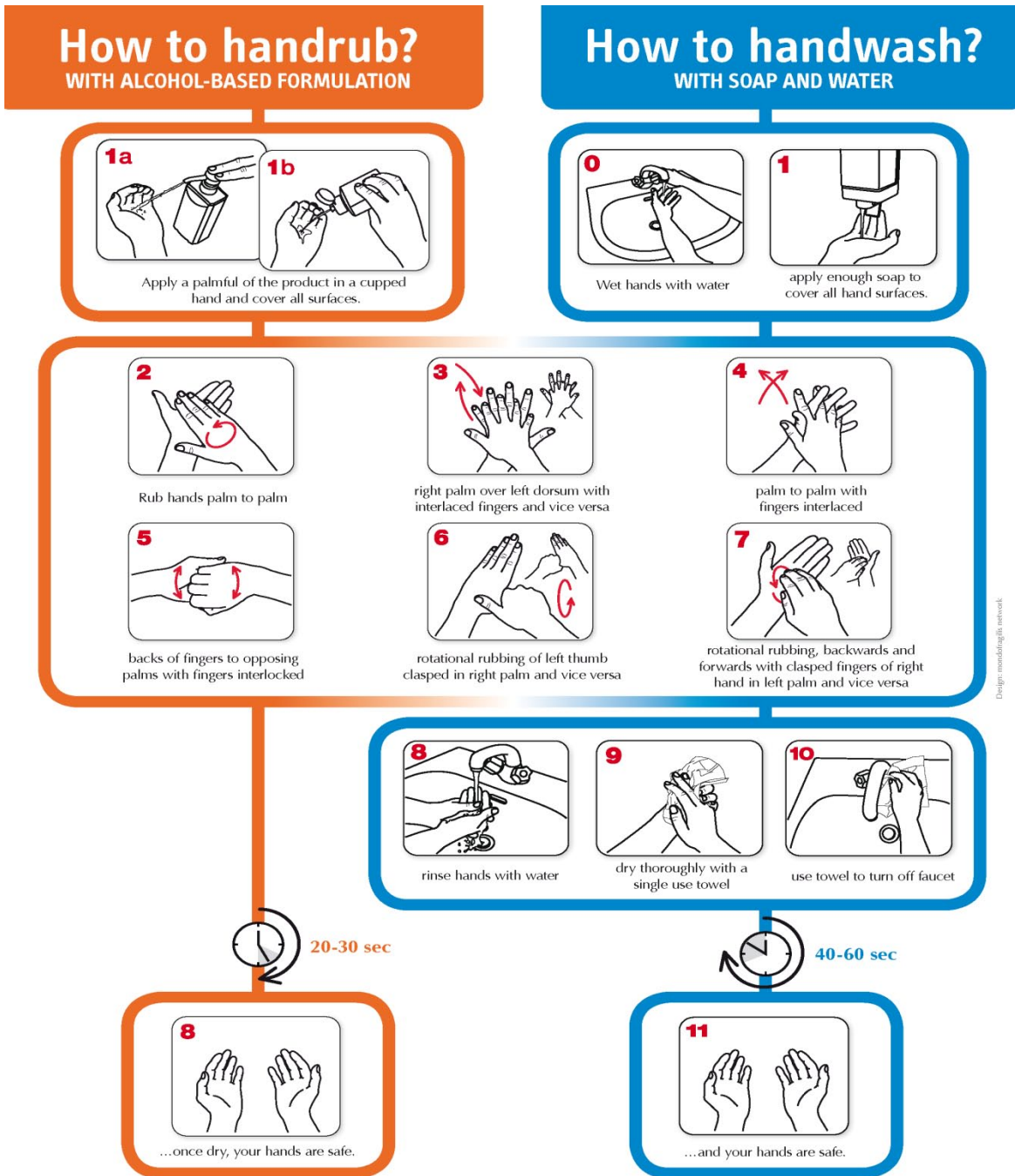

WHO acknowledges the Hôpitaux Universitaires de Genève (HUG), in particular the members of the Infection Control Programme, for their active participation in developing this material.



October 2006, version 1.

**Figure 10: Hand Washing**

Reproduced with permission from the World Health Organization

Accessed on July 7, 2009 from: <http://www.who.int/gpsc/tools/GPSC-HandRub-Wash.pdf>

## Sterilizing Distilled Water

### Why do I need sterile distilled water?

You will be instructed to use sterile distilled water several times in this manual. To help stop infections from happening you need to make sure you use **sterile** distilled water.

You will need sterile distilled water when you:

- ✓ Suction the trach tube
- ✓ Fill a pass over humidifier
- ✓ Clean the tracheostomy opening
- ✓ Clean the trach tube inner cannula

Legionella is a germ that can grow in water. To stop germs from growing, use *sterile distilled water*. You can buy *sterile distilled water* or you can boil distilled water to sterilize it. You can buy distilled water from your home care company, drug store or supermarket.

---

**IMPORTANT! Only use distilled water that has been sterilized. This will help stop lung infections from happening.<sup>1</sup>**

---

### How do I make sterile distilled water?<sup>2</sup>

Follow the directions below to make enough sterile distilled water to last 2 or 3 days. Do not use the water after the 3rd day. Make or buy more.

1. Find one pan with a lid, large enough to boil enough water for 2-3 days. Use this pan for sterilizing distilled water **only**. Do not use this pan to cook with
2. Bring the distilled water to a boil. Let boil for 5 minutes<sup>3</sup>
3. Turn off heat and cover the pan. Never leave the pan unattended. Use the boiled distilled water as soon as it has cooled or put it in a clean container and seal. It does not need to be refrigerated
4. To sterilize the containers, put the containers in the water and let the water boil for 10 minutes. Turn off heat and cover the pan with a lid
5. Leave the lid on the pan while the water is cooling. Do not use ice to cool down the water

---

<sup>1</sup> The APIC Curriculum for Infection Practice, Vol. III. 1988.

<sup>2</sup> This section on distilled water is courtesy of Hamilton Health Science and Saint Elizabeth Care.

<sup>3</sup> <http://www.phoenixchildrens.com/emily-center/child-health-topics/handouts/Sterile-Water-Saline-861.pdf>

## Tracheostomy Care

---

### What is a Tracheostomy?

A tracheostomy is an opening made into the windpipe just below the vocal cords. The hole, called the stoma, is where the trach tube is put in. You can breathe and cough through the trach tube as long as it stays clear.

The nose normally warms and moistens the air we breathe. With a trach, the air goes right into the lungs and not through the nose first. Without moisture your child's mucous will become thick and it will be hard to cough out. This can lead to problems breathing. There are ways to warm, filter and moisturize the air for those with a trach tube in place.

When someone has a trach tube you need a way to moisten and filter the air. This can be done using a nebulizer, a humidifier or a heat moisture exchanger (*HME*).

A trach tube can be cuffed or uncuffed. When the trach tube is cuffed, there is a balloon on the tube, called a cuff. When it is inflated it seals the airway. When the trach tube is uncuffed, some air can pass around the tube and up through the mouth and nose. Children with a cuffed trach tube cannot speak when the cuffed balloon is inflated. This is because no air is reaching the voice box. If the trach tube is uncuffed or the cuffed tube has the balloon deflated, the child can often speak with the trach tube in the airway. There are devices that can help the child with a trach speak.

A tracheostomy tube is often called a "trach tube." There are many kinds of trach tubes.

Your child has a \_\_\_\_\_ trach tube

## Going Home with a Trach

While in hospital you or a support person will learn how to care for your child's trach. When you go home your caregivers will assist you if you need help. Your community respiratory therapist, nurse or personal support worker will also support you.

Have a spare trach tube at all times. Keep the obturator available at all times.

This unit will cover the following:

- ✓ Description of trach tubes – parts and brands
- ✓ Stoma care – cleaning
- ✓ Trach tube care – cleaning and changing ties/holders
- ✓ Other information about trach tubes – cuffs, fenestrations and speaking valves
- ✓ Tracheal suctioning

When your child has a trach, it is a good idea to:

- ✓ Have your emergency numbers close by
- ✓ Have your community healthcare support telephone number close by
- ✓ Equipment supplier number, e.g. home care company, Community Care Access (CCAC)
- ✓ Keep a list of questions, problems, notes in a book or diary
- ✓ Keep a calendar for follow-up appointments

Setting up your home:

- ✓ Good lighting
- ✓ A place to put all your child's supplies; a room with shelves or an empty large drawer
- ✓ A room that is easy to keep clean and free of dust
- ✓ A comfortable spot in the room to sit or lie down
- ✓ A safe area away from other children and pets
- ✓ A place free of drafts away from open windows, heating ducts and fans

When doing your child's trach care:

- ✓ Your child's trach tube needs to be changed every 1 to 2 weeks
- ✓ Do trach care at the same time each day
- ✓ Set aside 20 to 45 minutes
- ✓ Limit distractions (do not answer your phone)

## Description of Tracheostomy (Trach) Tubes

Trach tubes are man-made airways that are made to fit into a cut in the neck.

There are many kinds of trach tubes. They can be made from rubber, plastic, silicone, nylon, Teflon, polyethylene, or metal. The most common type of tube is made from a plastic called Polyvinyl Chloride (PVC). All trach tubes are made with non-toxic materials.

All children have a different size neck, so the tubes come in different sizes. The length can vary from 5cm to 15cm and the width of the opening can vary from 2mm to 12mm wide.

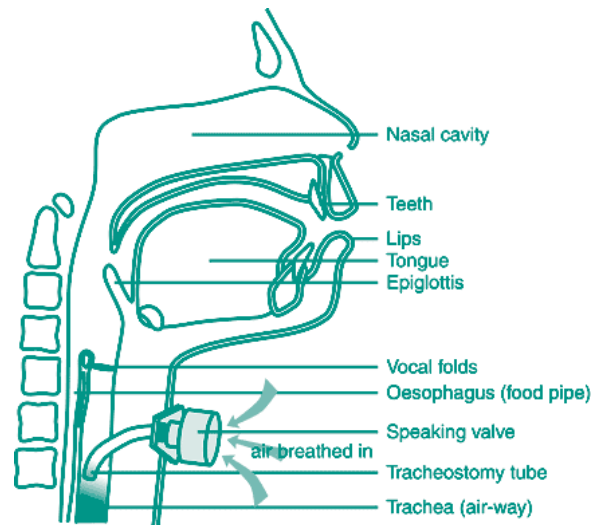
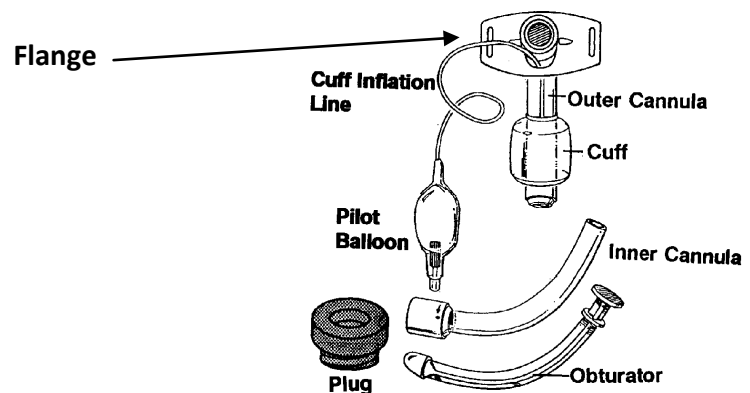

**Figure 11: Trach Tubes**

Reproduced with permission from Great Ormond Street Hospital for Children NHS Trust. Copyright GOSH 2008

[http://www.ich.ucl.ac.uk/gosh\\_families/information\\_sheets/speaking\\_valves/inhalation.gif](http://www.ich.ucl.ac.uk/gosh_families/information_sheets/speaking_valves/inhalation.gif)

## Trach Tube Parts



**Figure 12: Trach Tube Parts**

Reproduced with permission from the Ohio State University Medical Centre (OSUMC)

<http://medicalcenter.osu.edu/pdfs/PatientEd/Materials/PDFDocs/procedure/tube-care/trach/fenestr.pdf>



### Obturator (OB-ter-ay-ter)

- ✓ This is an important piece. The obturator goes into the trach tube and is used to put the trach tube in the stoma (opening). It is also used when changing trach tubes
- ✓ The obturator is specially made for the size of trach tube in that package. So you will **not** be able to use an obturator from one size trach tube to put in a tube that is a different size

---

**IMPORTANT! Keep the obturator somewhere where it is easy to find. If the trach tube falls out by accident, you need to use the obturator that came with that trach tube to put the trach tube back in.**

---

### Inner Cannula (CAN-you-luh)

- ✓ This is a smaller tube that fits inside the trach tube. It can be removed quickly if it becomes blocked with mucous
- ✓ Most inner cannulas are disposable, but some inner cannulas are reusable and need to be cleaned. Ask your child's nurse or respiratory therapist about what type you have and how to take care of it
- ✓ Some trach tubes do not have an inner cannula

### Flange

- ✓ This is the piece at the top of the trach tube that lies against the neck and is used to hold the trach to the child's neck
- ✓ Markings on the flange show the size and make of the trach tube

### Ties or holder

- ✓ Ties are used to hold the trach tube to the neck so it will not fall out. There are foam, Velcro®, and twill trach ties
- ✓ Care must be taken when putting the trach ties on. They are not to be tied too tight or too loose. When tied correctly you will be able to fit one or two fingers between the trach ties and the neck

## Cork

- ✓ A plug for the trach tube is also called a button, plug, or cap, depending upon the type of tube. It seals off the cannula of the trachtrach tube
- ✓ It allows the individual to breathe around the trach tube, through the upper airway. It also allows for speaking
- ✓ Not all patients can be corked
- ✓ Never inflate the cuff when the cork/cap is in use

---

**IMPORTANT! Make sure the cuff is deflated, or in the “down” position before using a cork. Take off the cork before you inflate the cuff.**

---

## Speaking Valve

- ✓ These are valves that are placed on the end of a trach tube to allow air to enter as your child breathes in. Air is sent around the tube and out the upper airway as your child breathes out
- ✓ Helps with speaking , and swallowing, and in some cases, coughing
- ✓ These valves are one-way
- ✓ **Never inflate the cuff with speaking valve in place**
- ✓ Not all patients can use a speaking valve

---

**IMPORTANT! Make sure the cuff is deflated, or into the “down” position before using a speaking valve. Take off the speaking valve before inflating the cuff.**

---

## Cuff

- ✓ Trach tubes are made with and without cuffs. An uncuffed trach tube has no cuff and no pilot balloon. A cuffed trach tube has a balloon-like device at the end. Most of the time uncuffed tubes are used for children
- ✓ The cuff is a small balloon that is at the end of the trach tube. When this balloon is inflated it seals against the wall of the windpipe. A seal is often needed when your child is on a ventilator. The seal stops the air flow from going into the mouth
- ✓ Some cuffs are filled with air, some are filled with water. If your child has a cuffed tube, it is important to know what the cuff needs to be filled with
- ✓ The cuff needs to be filled (inflated) with the smallest amount of air, or water to seal the airway

- ✓ When you inflate the cuff you are putting air or water into the *pilot balloon*. When the cuff is full of air or water it is said to be “up”. There is a set amount of air or water to fill the cuff and it is measured with a syringe. The amount of air or water will be different for each person and will depend on the size of the trach tube
- ✓ Care must be taken when inflating the balloon to avoid causing damage to the windpipe. Have your nurse or respiratory therapist show you how to properly fill the cuff
- ✓ When the cuff is flat, or deflated, it is said to be “down”. When the cuff is down there is no seal against the windpipe wall and air can go up through the vocal cords and out the mouth.

## Types of Trach Tubes

There are many kinds of trach tubes; there are Portex, Shiley and Bivona TTS Tubes.

### Portex and Shiley Tubes

- ✓ These tubes are made of plastic and can come with or without a cuff
- ✓ If these brands have a cuff, the cuff is always filled with air
- ✓ Some models have an inner cannula, some do not
- ✓ The Portex Blueline Ultra tubes are colour coded

---

**IMPORTANT! Always fill Portex and Shiley tube cuffs with air.  
Never fill with water.**

---

### Bivona TTS Tubes

- ✓ A *Bivona Tight-to-the shaft (TTS) Tube* is made of silicone and has no inner cannula.
- ✓ *Cuffed Bivona TTS Tube*. When the cuff is deflated, it flattens very close to the shaft of the trach tube, allowing for speech. Fill the cuff with sterile distilled water
- ✓ *Uncuffed Bivona Tube*. It looks the same as the Bivona TTS tube except there is **no** cuff or pilot line

### Cleaning Bivona Tubes

- ✓ You can re-sterilize these tubes up to 10 times
- ✓ These tubes have a special Superslick® coating on them that keeps mucous from sticking to them. Do not scrub too hard or the coating will come off

---

**IMPORTANT! Only use sterile distilled water to inflate TTS tube cuffs. If you fill it with air, it will leak.**

---

### How do I know when I should replace my trach tube?

You need to replace your trach tube when the:

- ✓ Obturator is too tight
- ✓ Trach shaft is not centred
- ✓ Trach tube is 'off color'
- ✓ Trach tube markings have faded

---

**IMPORTANT! Always have an extra trach tube with you at all times. Have a trach tube that is one size smaller than one in use. Keep the obturator on hand at all times.**

---

My child's trach tube type is: \_\_\_\_\_

My child's trach tube size is: \_\_\_\_\_

My child's trach:

- has an inner cannula
- does not have an inner cannula
- My child's trach has a cuff that:
  - needs to be filled with \_\_\_\_\_ ml of air
  - needs to be filled with \_\_\_\_\_ ml of water
- My child's trach does not have a cuff



**Figure 13: Bivona Tubes**

Reproduced with permission from Smiths Medical North America <http://www.smiths-medical.com/upload/products/mainImages/670180.jpg>



**Figure 14: Shiley Neonatal Tracheostomy Tube**

Reproduced with permission of Vitality Medical [www.vitalitymedical.com/isroot/Stores/VitalityMedical/picx1/SPX505080.jpg](http://www.vitalitymedical.com/isroot/Stores/VitalityMedical/picx1/SPX505080.jpg)



**Figure 15: Various Tracheostomy Tubes**

Reproduced with permission from the American College of Chest Physicians (Pulmonary & Critical Care Updates; Vol. 18, lesson 15) [www.chestnet.org/images/education/online/pccu/vol18/lesson15/fig1.jpg](http://www.chestnet.org/images/education/online/pccu/vol18/lesson15/fig1.jpg)

**See your personal information for your child's tube type and size.**

## Stoma Care

The stoma is the hole made in your child's windpipe that is kept open with a trach tube. Stoma care is the cleaning of the skin around the opening in the neck. Good stoma care will help prevent infections. Do stoma care at least once a day, such as first thing in the morning or just before going to bed. Clean it more often when the skin is swollen, red, or tender to touch.

### How do I clean the stoma?

1. You will need:
  - ✓ Sterile distilled water (or sterile normal saline)
  - ✓ Cotton tipped swabs or gauze
  - ✓ Sterile trach dressings
  - ✓ Disposable cups for water
  - ✓ Suction equipment
  - ✓ Disposable gloves
2. Wash hands well
3. Put on clean gloves
4. Make sure you are in a comfortable position. Make sure you can see the trach area easily.
5. Suction, if needed

---

**IMPORTANT! Make sure the trach tube is stable and not at risk of falling out during the cleaning process.**

---

6. Take off the old dressing and throw it in the garbage. Note the colour of the mucous, the amount of mucous and if there is any unpleasant smell
7. Check the skin around the trach opening (stoma) every day for signs of an infection

Watch for:

- ✓ Redness or swelling
- ✓ Creamy yellow or green mucous
- ✓ Crusting, dry mucous
- ✓ An unpleasant smell
- ✓ Pain or tenderness around the stoma
- ✓ Any extra tissue growth

Take note of any differences and report them to your healthcare professionals

8. Dip a cotton swab or gauze in sterile distilled water and clean the area around the opening, gently removing any dried mucous
9. Clean from the skin opening outward. Check to see that the opening is not open more than usual. Throw away each swab or gauze after use
10. Dip a new cotton-tipped swab or gauze in sterile distilled water and clean/rinse the area
11. Dry with fresh applicator swab or gauze
12. Put on the sterile dressing being careful not to twist the trach tube or pull on the flange
13. Change trach ties when they are dirty or when the Velcro® is no longer holding properly
14. Pour the water into the toilet and clean the containers
15. Take off gloves and wash hands well
16. Gather clean supplies so they are ready for the next cleaning

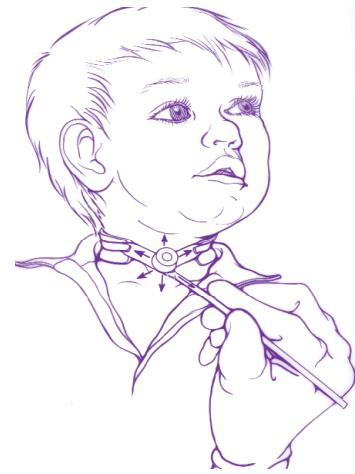

**Figure 16: Stoma Care**

Reproduced with permission from the Ohio State University Medical Centre (OSUMC)  
<http://www.trach.com/resources/pdf/tracheotomymanual.pdf>

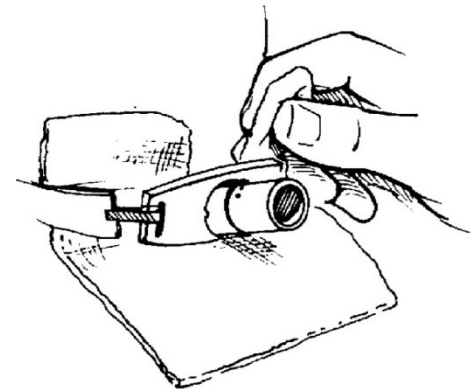

**Figure 17: Putting on the trach dressing**

Reproduced with permission from the Ohio State University Medical Centre (OSUMC)  
<http://medicalcenter.osu.edu/pdfs/PatientEd/Materials/PDFDocs/procedure/tube-care/trach/t-non-di.pdf>

---

**IMPORTANT! Dirty swabs and dressings may cause infections so they should be thrown away carefully. Wrap them in a plastic or paper bag and then put them in the garbage.**

---

## Trach Tube Care

### How do I clean my child's inner cannula and corks?

Many trachs have an inner cannula that needs to be cleaned or replaced on a daily basis. If there is a lot of mucous in the inner cannula, you need to clean it more often. Proper cleaning of the inner cannula will help stop lung infections from happening.

#### Daily

1. You will need:
  - ✓ A clean inner cannula, cork or speaking valve
  - ✓ Cotton tipped swabs or gauze
  - ✓ Tweezers
  - ✓ Pipe cleaners
  - ✓ Clean small plastic bags or dry container
  - ✓ Suction machine and supplies
  - ✓ Disposable gloves
  - ✓ Two covered containers to be numbered and labelled
2. Label the containers #1 and #2 to avoid mixing up the clean and dirty containers
3. *Container #1 is for the dirty cannula and corks.* Pour hydrogen peroxide or sterile distilled water into this container
4. *Container #2 is to rinse the cleaned cannula and corks.* Pour sterilized distilled water into this container
5. Wash hands well and put on clean gloves
6. Make sure you are in a comfortable position. Make sure you can see the trach area easily
7. Suction, if needed
8. Remove the dirty inner cannula, the cork or speaking valve from the trach tube and place it into container #1 (hydrogen peroxide or sterile distilled water)
9. Put in a clean inner cannula, cork or speaking valve and lock in place



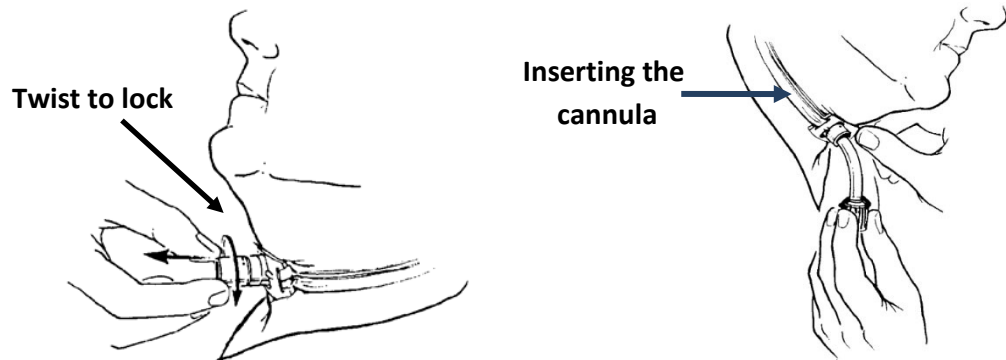

**Figures 18, 19: Cleaning the Cannula**

Reproduced with permission from the Ohio State University Medical Centre (OSUMC)  
<http://medicalcenter.osu.edu/pdfs/PatientEd/Materials/PDFDocs/procedure/tube-care/trach/t-non-di.pdf>

10. Remove the **dirty** cannula from **container #1** with tweezers and clean with a cotton swab, gauze, or pipe cleaners. Do not scrub
11. Look for cracks or breaks in the tube and locking mechanism. If there are cracks or breaks the trach tube needs to be changed
12. Place the cannula in **container #2** (sterile distilled water) and **rinse** well
13. Remove the cleaned cannula from container #2 (sterile distilled water) with the tweezers
14. Dry the outside of the inner cannula with clean dry gauze. Tap it against the gauze to remove any drops of water from inside the cannula



**Figure 20: Drying the inner cannula**

Reproduced with permission from the Ohio State University Medical Centre (OSUMC)  
<http://medicalcenter.osu.edu/pdfs/PatientEd/Materials/PDFDocs/procedure/tube-care/trach/t-non-di.pdf>

**IMPORTANT! Do not whip or shake the cannula to remove drops as this can spread drops into the air.**

15. Store the now clean inner cannula in a small clean plastic bag or dry container
16. Throw out all soiled supplies, along with the dirty distilled water and hydrogen peroxide
17. Wash all containers in soap and water. Rinse well. You can wash the containers on the top shelf in the dishwasher

18. Take off gloves and wash hands well
19. Get clean supplies ready for the next use

---

**IMPORTANT! Be sure to change the distilled water and hydrogen peroxide every day!**

---

### Weekly

Soak each container and lid in a solution of 1 part vinegar and 3 parts water for 20 minutes. Rinse and let air dry.

### How do I clean a metal or silver trach tube?

Hydrogen peroxide can damage these tubes. If you have a metal or silver trach tube, ask your respiratory therapist for cleaning instructions.

### How do I change my child's trach ties? <sup>4</sup>

Keeping the trach ties clean and dry will prevent skin irritation, sores and infections from occurring around the neck area.

The only thing holding the trach tube in place is the trach ties. These ties are usually made of twill cotton or cloth with a Velcro® closure.

When changing the ties be careful not to accidentally remove the trach tube. The ties should be changed by two people. One person will hold the trach in place while the other person cleans the skin and changes the ties. If a second person is not around to help, tie the clean ties first and then remove the old ones. This will keep the trach tube from coming out by accident.

---

<sup>4</sup> This section on changing trach ties is courtesy of "Changing Tracheostomy Ties" from the Department of Inpatient Nursing, The Ohio State University Medical Center 2005  
<http://medicalcenter.osu.edu/pdfs/PatientEd/Materials/PDFDocs/procedure/tube-care/trach/changing.pdf>

**Change the tie tapes daily and as needed.**

## 1. You will need:

- ✓ New trach tube ties
- ✓ Clean gloves
- ✓ Second person to assist, if available
- ✓ Tweezers
- ✓ Scissors
- ✓ Suction machine and supplies
- ✓ Tracheostomy Kit

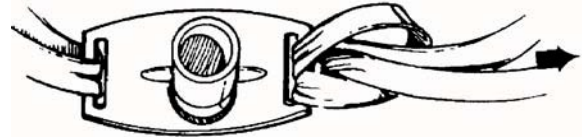
**Example of one method of securing cotton ties****Figure 21: Securing Trach Ties**

Reproduced with permission from the Ohio State University Medical Centre (OSUMC)

## 2. Make sure your child is in a comfortable position

## 3. Wash hands well and put on clean gloves

## 4. Have the second person hold on to the trach tube by gently holding onto the edges of the flange

## 5. Cut and remove the dirty trach ties. If your child has a pilot line on the cuff, take care that you do not cut it by accident

## 6. Put one end of the clean trach tie through the hole on one side of the flange. Use the tweezers to pull the trach tie through the hole

## 7. Bring both pieces of the ties around the back of the neck to the other side of the trach flange

## 8. Using tweezers take one end of the tie and pull it through the hole on one side of the flange

## 9. Bring the ends of the tie to the side of the neck and tie them in a knot

## 10. Do not tie them too tightly. Allow enough space for 1 finger between your child's neck and the trach ties

## 11. Take off gloves and wash hands well

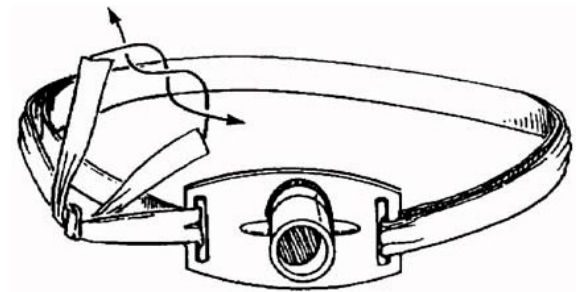
**Figure 22: Securing Trach Ties**

Reproduced with permission from the Ohio State University Medical Centre (OSUMC)

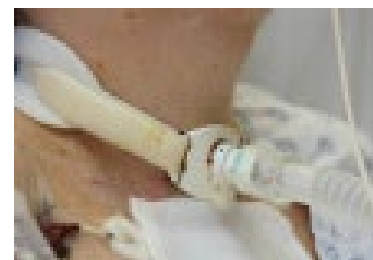
**Figure 23: Tapes with Velcro strips**

## Other Information About Trach Tubes

### What is a cuff?

A trach cuff is a balloon around the outside of the trach tube. When the balloon is inflated it fits the shape of your child's windpipe and seals off the space between the wall of your child's windpipe and the trach tube. This seal might be needed when your child is on a breathing machine (ventilator). If the cuff is not inflated, air can pass around the outside of the trach tube up through the voice box.

The cuff is inflated by putting either air or water in through the pilot line. If your child has a cuffed *Shiley* or a *Portex* trach tube, you will fill the balloon with *air*. If it is a *Cuffed Bivonia TTS Tube*, you will fill the balloon with *distilled water*.

The pilot balloon on the inflation line shows whether the cuff is 'up' or 'down'. The pilot balloon does not tell you how much air or water is in the cuff. Ask your respiratory therapist or nurse how much air or water needs to be in your child's cuff.

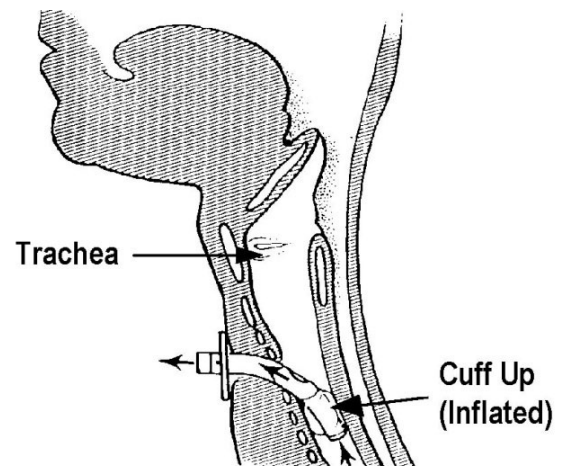

**Figure 24: Inflated Cuff**

Reproduced with permission from the Ohio State University Medical Centre (OSUMC)

---

**IMPORTANT! Make sure that you know how much air or water needs to go into your child's cuff. Ask your healthcare professionals to show you how.**

---

## Inflating the Cuff – Putting the Cuff “up”

1. Make sure that the trach tube is not blocked, so the air can move freely through it. Before inflating the cuff, attach a syringe to the cuff pilot line. Draw back on the syringe to suck out any air that may be in the cuff. The cuff needs to be fully “down” before filling it again. If the pilot balloon already has air in it you should **not** add more air

**IMPORTANT! Never add air to a cuff that already has air in it.**

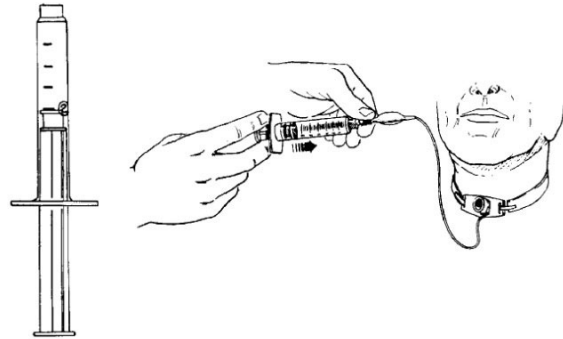

**Figure 25: Inflating the Cuff**

Reproduced with permission from the Ohio State University Medical Centre (OSUMC)

- ✓ Your child’s trach has a cuff that needs to be filled with:
- \_\_\_\_\_ ml of air (Shiley or Portex tubes)
  - \_\_\_\_\_ ml of distilled water (Bivona TTS Tube)

2. Attach the syringe to the cuff pilot line. Slowly push the plunger in so the air (or distilled water) fills the cuff with the right amount
3. Remove the syringe. There is a valve in the pilot line that stops the air or water from leaking out
4. If there is a leak around the cuff, see see “How do I fix a Cuff Leak?” question below.

**IMPORTANT! If the cuff is filled with too much air or water, it will cause damage to the trachea. Do not over inflate the cuff.**

## Deflating the Cuff – Putting the Cuff “down”

1. Suction the mouth, if needed

**Note: Sometimes mucous sits in the throat or on top of an inflated cuff. When the cuff is deflated, this mucous can fall from around the cuff into the lungs making your child cough. It is a good idea to have a suction catheter ready in case this happens.**

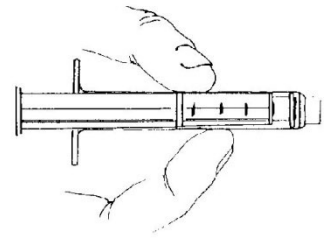

**Figure 26: Syringe**

Reproduced with permission from the Ohio State University Medical Centre (OSUMC)

2. Get a syringe (without the needle) and push the plunger all the way in to remove the air from the syringe
3. Attach the syringe to the cuff pilot line
4. Slowly pull back on the plunger of the syringe until the pilot balloon on the cuff pilot line is flat and the syringe plunger cannot be pulled back any more
5. You have now deflated the cuff

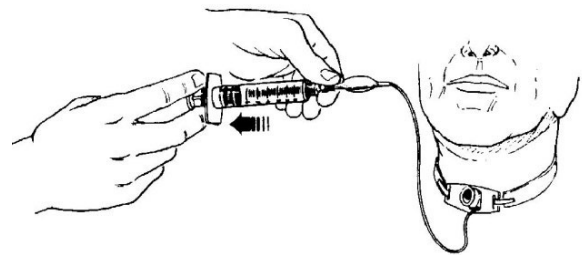

**Figure 27: Deflating the Cuff**

Reproduced with permission from the Ohio State University Medical Centre (OSUMC)

## How do I fix a cuff leak?

First remove all the air (or distilled water) from the cuff. Then reinflate the cuff with the right amount of air or distilled water. Wait a few minutes. If there is a leak, then:

1. Remove all the air or distilled water from the cuff
2. If the amount removed was less than it was suppose to be, and then re-inflate with the correct amount
3. If your child’s cuff is filled with air you can try this. Put the pilot balloon in a cup of water while it is “inflated”. If you see bubbles then there is a leak in the pilot line or pilot balloon
4. If there is still a leak, the trach tube needs to be changed

### I have tried everything and there is still a leak in the cuff, what do I do now?

If you have been given directions on how to do this, and you are comfortable doing a trach change, then change the tube. If you have not been told what to do, or you are not comfortable call homecare professional or respiratory therapist for help. If no one is available to help, go to the nearest emergency room.

## Speaking Valves

A speaking valve is a one-way valve that allows air in but not out. The one-way valve connects to the trach tube and only opens when your child breathes in, letting air go into the lungs. The valve will close when your child breathes out, forcing the air up around the outside of the trach tube, through the voice box, and out the mouth, so your child can speak.

There are many brands of speaking valves, but the Passy Muir valve is the most common. Speaking valves can be used while your child is on humidity or oxygen and even if they are on a ventilator.

Speaking valves can improve:

- ✓ Swallowing – You child will be less likely to choke on food
- ✓ Smelling – Your child will smell food and have an improved appetite
- ✓ Coughing – Your child will have a stronger cough and will not need to be suctioned as often

### Special Considerations

- ✓ **Do not use with inflated trach cuff**
- ✓ The valve may occasionally pop off; just replace it cleaned and be sure connections are tight
- ✓ The valve can be attached to the trach tie with a fastener



**Figure 29: Boy with Speaking Valve**  
Reproduced with kind permission from [www.trach.com](http://www.trach.com)

Remove the speaking valve when:

- ✓ Having an aerosol treatment
- ✓ Suctioning is needed
- ✓ Sleeping

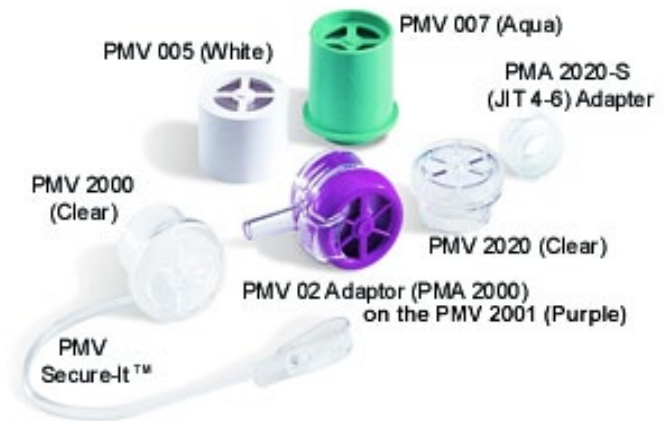

**Figure 28: Passy-Muir® Tracheostomy Speaking Valve**

This section on speaking valves is courtesy of “Passy-Muir® Tracheostomy Speaking Valve” from the Department of Inpatient Nursing, The Ohio State University Medical Center, 2002

<http://medicalcenter.osu.edu/pdfs/PatientEd/Materials/PDF/Docs/procedure/tube-care/trach/passey.pdf>

**IMPORTANT! Never use a speaking valve when the cuff is “up” or in the inflated position.**

Your child’s trach speaking valve is: \_\_\_\_\_



### How do I use a speaking valve?

#### **If your child is not on a ventilator and is able to breathe on their own:**

1. If the mucous cannot be coughed out, then suctioned it out
2. Completely deflate the trach tube cuff
3. Remove the oxygen and humidity, if you have it on

#### To put the valve on:

1. Gently hold on to the edges of the trach tube flange and put the speaking valve onto the trach tube
2. Twist the valve gently to make sure it is on the trach tube properly. The valve may sometimes pop off. If this happens just replace it and be sure the connection is tight
3. Replace the oxygen and humidity, if you have it

#### To remove the valve:

1. Gently hold the flange and twist the valve off
2. Replace the oxygen and humidity, if you have it

#### **If your child is on a ventilator and cannot breathe on their own:**

1. If the mucous can't be coughed out, then suction it out
2. Completely deflate the trach tube cuff (Put the cuff 'down')
3. Place the valve in-line with the ventilator tubing in the following way. Have your nurse or respiratory therapist fill in the steps you should follow below:
  - a. \_\_\_\_\_
  - b. \_\_\_\_\_
  - c. \_\_\_\_\_

4. Change the ventilator settings to:  
FiO<sub>2</sub> or O<sub>2</sub> litre flow: \_\_\_\_\_ Tidal Volume: \_\_\_\_\_  
Pressure Control: \_\_\_\_\_  
Alarms: Low Pressure; test to be sure that the Low Pressure Alarm is working with the valve in-place
5. To remove the valve, take the valve out of the ventilator circuit
6. If your child is on a ventilator return the settings to:  
FiO<sub>2</sub> or O<sub>2</sub> litre flow: \_\_\_\_\_ Tidal Volume: \_\_\_\_\_  
Alarms: \_\_\_\_\_  
Other: \_\_\_\_\_
7. When the speaking valve is removed, it is safe to inflate the cuff again

### How do I clean my child's speaking valve?

Clean the speaking valve every day using a mild soap and warm water. Rinse well. Allow to air dry. When dry, store in sealed plastic container when not using.

Some cleaning products will damage the valve.

---

**Do not use the following:**

**Hot water or harsh chemicals**

**Hydrogen Peroxide, bleach**

**Alcohol**

**Cleaning brushes**

---

### When can I get a new valve?

If you take care of these valves they will last a long time. Before replacing a valve with a new one first wash and dry it carefully. If the valve is still sticky, noisy or begins to vibrate it needs to be replaced. Talk to your respiratory therapist for more information.

## Trach Kit

- Trach tube of current size
- Trach tube that is half a size smaller than the current one
- Obturator
- Trach ties
- Water soluble lubricant
- Normal saline nebulas
- Trach gauzes
- Scissors
- Suction unit
- Suction catheters
- Suction tubing
- Oximeter with probe
- Manual Resuscitator Bag

## Tracheal Suctioning

Suctioning removes mucous from the windpipe and the trach, keeping the airway open. A suction catheter is a tube that is used to take out mucous from the lungs and mouth.

The suction pressure will be:

- ✓ For babies: 60-80 mmHg (8-10 kPa)
- ✓ For older children: Up to 120 mmHg (<16 kPa)

**Ask your healthcare professional to write down the suction unit pressure: \_\_\_\_\_**

**Size of suction catheters to be used: \_\_\_\_\_ fr**

## How to Suction

---

**IMPORTANT! Check your suction equipment every day; it must always be ready-for-use.**

---

1. You will need:
  - ✓ Suction machine – electrical or portable
  - ✓ Suction tubing
  - ✓ Distilled water (flushing solution)
  - ✓ Clean container for flushing solution
  - ✓ Disposable suction catheters of correct size
  - ✓ Clean disposable gloves
  - ✓ Mask
  - ✓ Manual resuscitation bag with flex hose and trach adapter, if needed
  - ✓ Extra inner cannula if needed
  - ✓ Obturator
  - ✓ Hand sterilizer
  - ✓ Suction unit plug and charger, if needed
  - ✓ Plastic bag for disposal of materials
  
2. Wash hands well
3. Fill the container with sterile distilled water
4. Attach the suction catheter to the connecting tubing of the suction machine
5. Turn on the suction machine and be sure there is good suction
6. Make sure the person you will be suctioning is in comfortable position. Their head should be above their shoulders
7. Put on clean gloves being careful not to touch anything except the catheter
8. Push the thumb control through the paper backing on the package, and attach it to the suction tubing

---

**IMPORTANT! Use a clean suction catheter for each suction session.**

---

9. Withdraw the catheter from package slowly. Hold the catheter with your gloved hand 10 to 15 cm (4 to 6 inches) from the tip. Be careful not to have the catheter touch anything
10. Remove the ventilator, trach cork or speaking valve. from trach tube. If necessary, bag the child with a manual resuscitator
11. Dip the catheter tip into flushing solution and suction a bit of fluid into the catheter to make sure it works
12. Insert the catheter into trach tube only as far as you were told to go

***Note: There are three ways to suction: Deep suctioning, Tube Suctioning and Tip Suctioning. Ask your healthcare professional to show you how to suction these three ways.***

#### **Deep Suctioning**

Put the catheter in until you feel something stopping you. Pull the catheter out a bit then gently use the suction.

#### **Tube Suctioning**

The catheter is only put just past the end of the trach tube. It is not put all the way into the lungs.

#### **Tip Suctioning**

The catheter tip is used to suction just at the opening of the trach tube.

---

**IMPORTANT! Do not push or force the catheter.**

---

13. You are now ready to apply the suction. Cover the thumb hole on the catheter and slowly take the catheter out while twisting, or 'rolling' it between your fingers. You can pull the catheter straight out or roll it back and forth between your fingers. It all depends on what works best to remove the mucous. It takes practice to find what works best to remove the mucous

---

**IMPORTANT! Do not cover the thumb hole on the catheter until you are ready to suction. Suction only when you are removing the catheter.**

---

---

**IMPORTANT! The suction catheter should not be in the trach for more than 5 seconds.**

---

14. Look at the mucous being suctioned out. Take note of the amount, the colour, the thickness and the smell
15. Rinse the catheter out by dipping the tip into sterile distilled water and suction water through the catheter until it is clear. You can use the same catheter to suction a few times, as long as it is kept clean. However, if the catheter becomes blocked with mucous, remove it and use a new one
16. Repeat steps 12 to 15 if needed. Ways to know if you need to suction again
  - ✓ Ask if they feel “okay” or if they want to be suctioned again
  - ✓ If you hear “gurgling” when they are breathing, then you need to suctioned again

***Note: Suctioning can cause your child to feel very short of breath. So take breaks between suction attempts. You may need to place the child back on ventilator for a while or give some manual breaths with the resuscitation bag.***

17. When done, replace the trach cork, speaking valve, or ventilator, if needed
18. Coil or wrap the suction catheter around the fingers and palm of one hand, then pull the cuff of the glove over the top of the coiled catheter to completely cover it. Throw out the gloves and dirty catheter. Throw out the suction catheter after each suction session. Dispose of glove / catheter and cup
19. Turn off the suction unit
20. Empty and clean the suction drainage bottles and containers, if needed
21. Wash hands well
22. Be sure the suction equipment and supplies are ready for the next use. You never know when you need to suction your child. Have all the equipment ready in case you need it quickly

### When should I suction my child?

Many children need to be suctioned at least once a day, such as first thing in the morning or before going to bed.

Your child needs to be suctioned when:

- ✓ They can coughing a lot and are not able to cough up the mucous
- ✓ They are having trouble breathing or their breathing sounds harsh
- ✓ The ventilator airway pressures are higher than normal
- ✓ You see mucous in the trach tube or in the ventilator tubing

### Why does my child feel so short of breath when they are being suctioned?

Oxygen is removed from the airway when someone is being suctioned. Try to keep the suction time to less than 5 seconds. This will help. Allow your child to take a few breaths between suction attempts, to give your child a break.

Use a manual resuscitator bag before and after suctioning. This often helps move the mucous up the airway so it is easier to suction or cough up. This may also help with the shortness of breath that occurs when being suctioned.

### Why is blood coming up the suction tube?

This may be happening because the catheter is pushed too hard into the airway. Sometimes it happens if the suction catheter is too large. You can prevent bleeding by using the right size catheter and not forcing the catheter down the airway.

### Suctioning on the go:

Before going out make sure the portable suction unit is fully charged and you have all your supplies.

Portable suction supplies:

- ✓ Suction catheters
- ✓ Connecting tubing
- ✓ Gloves
- ✓ Masks
- ✓ Hand sterilizer
- ✓ Distilled water, if desired

- ✓ Spare inner cannula, if applicable
- ✓ Manual resuscitator
- ✓ Trach Kit

### Other Helpful Tips

- ✓ The same catheter may be used during each suction attempt as long as it has remained clean
- ✓ The same suction catheter should not be used for more than one suction session
- ✓ If the catheter becomes plugged, throw it out. Replace with another sterile catheter
- ✓ Some individuals may have to be manually ventilated (bagged) before and after suctioning. This may help move mucous higher in the airway. This may also help with breathing
- ✓ Replace cork/speaking valve and/or the heat and moisture exchanger when needed
- ✓ Suctioning is a clean procedure so it does not require the use of sterile gloves. Clean gloves are used to act as a protective barrier so that secretions or organisms cannot be transferred to the caregiver

## Changing the Trach Tube

Some children change their trach tube once a month, others change it more often. Some will change it if it becomes plugged or falls out by accident. The following are steps everyone in the family needs to know. In case of an emergency, you need to be prepared and know what to do. Everyone in the family should know what to do if the trach were to become plugged, or falls out by accident. Do a practice-drill at home, so you can remain calm if these situations arise.

For a trach change, it is best if you have a second person to help you.

#### 1. You will need:

- ✓ Clean or new trach tube with obturator; same size as the one that is currently in
- ✓ One size smaller trach tube – in case of an emergency where you cannot get the new same size tube in
- ✓ Trach ties
- ✓ Supplies to clean the stoma
- ✓ Syringe, if the tube is cuffed
- ✓ Scissors
- ✓ Sterile distilled water
- ✓ Manual resuscitation bag and mask



- 
- ✓ Water soluble lubricant
  - ✓ Suction machine and suction catheter
2. Wash your hands well and put on clean gloves
  3. Check the new trach tube:
    - ✓ Remove the trach tube from the package. Look at the new tube. If you notice any cracks or breaks get a new tube
    - ✓ If there is a cuff on the tube, check that it is working by inflating it and deflating it
    - ✓ Inflate the cuff with air or water, as ordered by your doctor. If you notice a leak, get another tube. If there are no problems, deflate the cuff completely
  4. To keep the tube as clean as possible, touch only at the flange
  5. Put the obturator into trach tube
  6. Lubricate the end of the trach tube with a water soluble lubricant
  7. Make sure the child is comfortable and lying on their back with their neck tilted slightly backward. To do this, some people find it helpful to put a rolled towel under their shoulders
  8. Do stoma care, if needed
  9. Suction, if needed
  10. Have the second person hold the trach tube at the flange. Remove the old trach ties. Take care the trach tube does not fall out accidentally
  11. If the child has a cuffed tube, deflate the cuff completely
  12. Take out the old trach tube but try not to pull it straight out. Use a motion that follows the curve of the trach tube
  13. Guide the new trach tube into the stoma. Again, try to using a motion the follows the curve of the trach tube
  14. As soon as the new trach tube is in, remove the obturator
  15. If the child is on a ventilator and has a cuffed tube, inflate the cuff
  16. Place back on ventilator, or oxygen, if needed
  17. Tie the trach ties and put on a clean dressing
  18. Wash your hands

**What should I do if I cannot get the trach tube in?**

1. Moisten the trach tube with sterile distilled water and try again
2. Make sure you are using the obturator and that the cuff is completely deflated
3. Make sure the neck is extended. You may need to reposition the child
4. If the child can breathe and is not in distress:
  - ✓ Ask the child to take a big breath in. Guide the tube in as they breathe in
  - ✓ Try to put in a smaller size trach tube in
5. Put the obturator into the stoma and gently pull down on the skin around the opening. This should open the stoma a little more giving you room to put in the smaller trach tube
6. If the smaller tube will not go in and the child is having trouble breathing:
  - ✓ Put the face mask on the manual resuscitator bag and place the mask over the nose and mouth to ventilate. You will need to cover the stoma
  - ✓ Have the second person call 911

**The trach tube is out a little, but has not completely fallen out.****What do I do?**

1. Deflate the cuff on the trach tube (if it has one)
2. Gently push the tube back in
3. Adjust the ties so the trach tube will not fall out

**What do I do if the trach tube is plugged?**

1. If the child is on a ventilator, the high pressure alarm will probably go off
2. Check to see if your child is having trouble breathing
3. If so, try suctioning. If the suction catheter does not go down the trach very far then it may mean that the tube is plugged
4. If your child is having trouble breathing you will need to act fast. Remove the trach tube and insert a new one

# Mechanical Ventilation

---

## What is Mechanical Ventilation?

Your child may need a ventilator to move air in and out of their lungs because they can not breathe well enough on their own. The ventilator can do all of the breathing (total support) or just partly help your child's own breathing effort (partial support). Most ventilators can give extra pressure (PEEP pressure) to keep the lungs open so the air sacs do not collapse. Mechanical Ventilation can be done using a ventilator and a trach tube, a ventilator and a mask, or a ventilator and a mouthpiece.

### Total Support

Those children who need the ventilator to do all their breathing would be on total support. A trach tube is often used for those who need the ventilator to do all their breathing. People on 'total support' are not able to use a mask.

### Partial Support

This is when the person is able to breathe on their own in-between the breaths delivered by the ventilator. The ventilator does not have to deliver the full breath, if the person has some breathing effort of their own.

## Why is Mechanical Ventilation Needed?

Certain lung diseases change how the respiratory system works. Mechanical ventilators are used when the:

- ✓ Brain cannot send signals to the lungs to breathe
- ✓ Lung is too stiff to expand fully
- ✓ Lung tissue is damaged causing breathing problems
- ✓ Muscles for breathing are not strong enough to move air in and out of the lungs
- ✓ Heart has been damaged and causes the lungs to work very hard

## Ventilator Settings

Below is a list of the most common ventilator settings. Your child's ventilator settings will depend on your ventilator type and mode.

## Modes of Ventilation

The ventilator mode is how the ventilator delivers the breath.

Common ventilator modes are:

AC or C - Assist/Control or Control

IMV - Intermittent Mandatory Ventilation

SIMV - Synchronized Mandatory Intermittent Ventilation

CPAP- Continuous Positive Airway Pressure

PS - Pressure Support

When Pressure Support is working, the machine will deliver a set pressure when the child breathes a breath on their own. It helps to boost the breath, so it is larger than they might do on their own.

PC - Pressure Control

This sets the highest pressure to be delivered during a breath. This pressure is held for the whole 'breathing in' time.

**Ventilator Rate**

- ✓ Also known as Breath Rate and Respiratory Rate
- ✓ The number of breaths the ventilator delivers in one minute

**Tidal Volume**

- ✓ The amount of air the ventilator gives with each breath

**Inspiratory Time**

- ✓ The time it takes for the ventilator to give one breath

**Inspiratory Flow Rate**

- ✓ How fast the air travels during one breath

**I: E Ratio (Inspiratory to Expiratory Ratio)**

- ✓ The length of time it takes to breathe in compared to the time it takes to breathe out
- ✓ This is often expressed as a ratio

**Peak Inspiratory Pressure (PIP)**

- ✓ This shows the amount of pressure it takes to fill up the lungs when your child breathes in
- ✓ The number shown may be slightly different with each breath
- ✓ Each person has a normal PIP
- ✓ The amount of pressure is displayed on the control panel of the ventilator, either as a number on a screen or on a gauge

**PEEP (Positive End Expiratory Pressure)**

- ✓ This is the pressure the ventilator holds at the end each breath. PEEP helps to keep the air sacs open so they do not collapse

### Sensitivity or Breathing Effort

- ✓ This control shows how much effort is needed to start a new breath from the ventilator

### Low Pressure Alarm

- ✓ This is a safety alarm that goes off when the ventilator does not reach the pressure needed to give the full breath
- ✓ This usually means there is a leak somewhere in the tubing or that the ventilator tubing has come off the patient's trach tube. For a more information on low pressure alarms, see the **Troubleshooting** section

### High Pressure Alarm

- ✓ This is a safety alarm that goes off when the ventilator reaches the high pressure setting
- ✓ This usually happens when:
  - There is a blockage in the airway, often caused by too much mucous. Your child might need to be suctioned
  - Your child is wheezing, coughing or hiccupping
  - There is a kink in the ventilator tubing

### Oxygen

- ✓ If your doctor wants to give more oxygen, it may be added into the ventilator tubing

Your ventilator is a: \_\_\_\_\_

The ventilator settings are: \_\_\_\_\_

---

## Ventilator Power Sources

Ventilators operate on electricity. There are three sources of electricity that are available to run the ventilator: Alternating Current (A/C), External D/C battery and Internal D/C battery.

### Alternating Current (A/C)

Most of the time your child's ventilator will be plugged into your home wall outlet which is 120 volts of alternating current (A/C). Always use wall outlet power if you are planning to stay in one place.

### Internal Direct Current (D/C)

This is the battery inside the ventilator. It is used when there is a sudden drop in electricity to power the ventilator. This may happen when the ventilator is unplugged accidentally, or during a power failure. A fully charged battery should keep the ventilator working for about 30-60 minutes.

This battery should not be used often. This battery is a safety feature and is only to be used in an emergency. Keep the ventilator plugged into a wall outlet so the battery will always be charged.

The Internal D/C battery is:

- ✓ Built into the ventilator
- ✓ For short term emergency power only
- ✓ On when the ventilator is on
- ✓ On when you unplug the ventilator from the wall or an external D/C battery
- ✓ Recharged when the ventilator is plugged in to a wall outlet
- ✓ Able to power the ventilator for 30-60 minutes, if it is fully charged
- ✓ To be discharged and recharged every month

***Note: Depending on the ventilator, this battery may not recharge when the ventilator is plugged into a D/C external battery. Check with your respiratory therapist.***

### External Direct Current (D/C)

If a power failure were to last longer than 30-60 minutes, the battery inside your ventilator will not last. So you need to have another way to power the ventilator, if this were to happen.

The Ventilator Equipment Pool (VEP) provides an external D/C battery for emergencies such as a power outage. The battery is a standard 12 volt battery that would provide power to the ventilator for 5 - 12 hrs.

---

**IMPORTANT! This battery should not be used for portability, such as with a wheelchair. They are for emergency backup power only.**

---

### How do I hook up the external battery to the ventilator?

1. Check to make sure the battery is fully charged. If it needs charging, do so first. Never charge the battery while the battery is connected to the ventilator
2. Place the battery in a safe place away from the ventilator's inlet filter (on the back of the ventilator panel). Do not put the battery on top of ventilator
3. Plug the battery cable into the proper connection on the ventilator
4. Plug the battery cable into the battery

---

**IMPORTANT! Some internal ventilator batteries may not recharge when the ventilator is plugged into an external D/C battery.**

---

### How do I remove the external battery from the ventilator?

1. Unhook the battery cable from the battery
2. Unhook the battery cable from the ventilator
3. Make sure ventilator is plugged into the wall outlet (A/C power source)
4. Recharge the battery in a well ventilated area



### I would like to use my child's ventilator with their wheelchair. What battery should I use?

- ✓ A battery is needed when you use your child's ventilator with their wheelchair. You will need to buy another battery for this purpose
- ✓ Do not use the external battery that VEP has given you. That one is for emergency use only. **VEP does not supply batteries for wheelchair use**

### When do I need to recharge the external battery?

- ✓ Recharge the battery after every use in a well ventilated area
- ✓ Old batteries will lose their charge quickly so check the battery charge every week
- ✓ Discharge and recharge the battery monthly

### How do I recharge the external battery?

1. Charge the battery in a well ventilated area
2. Do not charge the battery when it is hooked up to the ventilator
3. Use a 12 volt battery charger to recharge the battery
4. Connect the battery to the charger
5. Connect the charger to the wall outlet (A/C power)
6. Let the battery charge. **Note: It will take one hour of recharge time for every hour that it was used**
7. When the battery is 80% charged, the yellow light will flash
8. When the battery is 90% charged the green light will come on. When the green light is on it means the charge is complete
9. Leave the battery hooked up to the charger for another 3 hours **after** the green light comes on
10. When the battery is fully charged, unplug the charger from the wall outlet first, before unhooking the charger from the battery

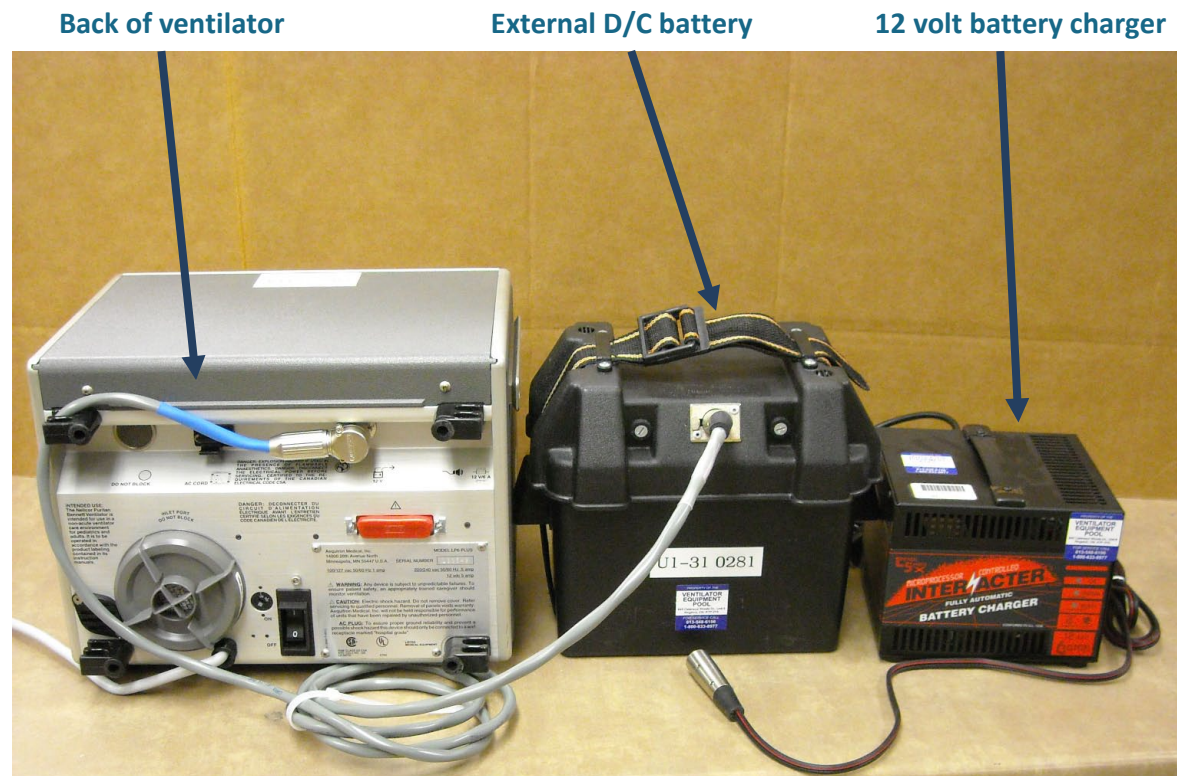

**Figure 30: Ventilator & Battery**

Photo courtesy of Ventilator Equipment Pool

### General Tips: Ventilator Management

- ✓ Place the ventilator on a night stand or a table away from drapes or other things that could block the air flow to the inlet filter opening
- ✓ Spills will damage the ventilator and cause it to not work properly. Never place food or liquids on top of the ventilator
- ✓ Use the protective doors, covers or lock out features on the ventilator. They protect the settings from being changed by mistake
- ✓ Make sure the humidifier is lower than your child's head
- ✓ Make sure the alarm port is not blocked by objects. If it is blocked, it may not be heard if it goes off

### Daily

- ✓ Make sure the ventilator is plugged into a 3 - pronged wall outlet (A/C power source)
- ✓ Turn the ventilator on and check that the proper lights and sounds come on. Your ventilator manual will tell you what to look for
- ✓ Check the ventilator settings to make sure that they are set correctly
- ✓ Check the respiratory rate. To do this your child cannot be connected to the ventilator. Hold a glove tightly over the flex tube connector where it would attach to your child. Count the number of breaths for one minute (60 seconds). It should be the same as the set breath rate on the machine
- ✓ Test the Ventilator Circuit by doing a 'Low Pressure Test' and a 'High Pressure Test'

### Weekly

- ✓ Wipe down the ventilator with a damp cloth
- ✓ Clean and change the Ventilator Circuit
- ✓ Clean the Portable Suction machine
- ✓ Check that the external battery is charge

### Monthly

- ✓ Change the bacteria filter in the breathing circuit
- ✓ Change or clean the inlet filters on the ventilator. These must be replaced/cleaned as needed
- ✓ Discharge and recharge the external battery

### Annually, or as needed

- ✓ Preventive maintenance is recommended by the manufacturer. Some ventilators need to be serviced every 1-2 years, or after a certain number of hours of use
- ✓ The Ventilator Equipment Pool will contact you to arrange service on your machine

## The Ventilator Circuit

Below is a picture of a ventilator circuit. Your ventilator circuit may look a little different than this picture. Circuits currently provided through the Ventilator Equipment Pool. Please see specific user's manual for circuit details.

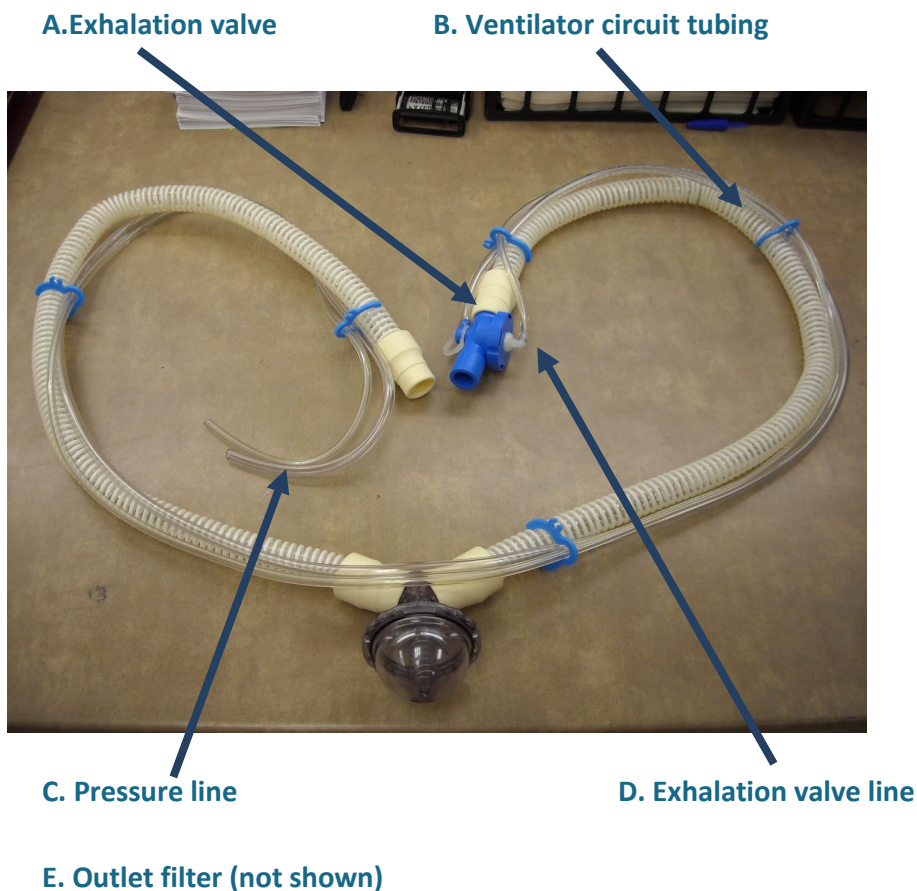

**Figure 31: Ventilator Circuit**  
Courtesy of Ventilator Equipment Pool

**A The exhalation valve:** is a balloon that closes when someone breathes in and opens when they breathe out. The flex tube attaches to one end and the ventilator circuit tubing to the other end.

**B The ventilator circuit tubing:** is a 6 foot hose that attaches to the exhalation port at one end and to the outlet port on the ventilator on the other end.

**C The pressure line:** is a small tube that is connected to two pressure ports; one on the ventilator and the other on the exhalation valve.

**D The exhalation valve line:** is connected to the exhalation valve and the exhalation valve port on the ventilator.

**E The outlet filter:** this filters gas coming from the ventilator, going into the ventilator circuit tubing (not shown in the picture above)



**Figure 32: LTV 950 Ventilator**

Reproduced with permission of CareFusion [www.CareFusion.com](http://www.CareFusion.com)

Figure 32 shows the LTV 950 ventilator. Your child's ventilator may look different than the picture shown here.

### How do I clean and change the ventilator circuit?

Clean the ventilator circuit, resuscitation bag, humidifier and suction canister at least once a week.

1. You will need:
  - ✓ Mild dishwashing soap
  - ✓ Pail for soaking
  - ✓ Water
  - ✓ White vinegar
  - ✓ Clean towel
  - ✓ Storage bag
2. Take apart the ventilator circuit. This includes the tubing, connectors and humidifier reservoir jar, if used. Refer to your Patient Circuit Assembly Instructions

---

**IMPORTANT! The ventilator will *not* work properly if water gets into the pressure sensor line or exhalation valve.**

---

3. Wash tubing and connectors in warm soapy water
4. Rinse with tap water to remove the soap
5. Make a solution of 1 part vinegar to 3 parts water in the pail. Soak humidifier jar, tubing, and connectors in the vinegar solution for 30 minutes. Make sure that all the parts are in the solution
6. Drain and rinse well. Place connectors and humidifier jar on a clean towel to air dry. Hang the hoses to dry. Allow all parts to air dry completely before putting back together
7. Look carefully at the tubing and equipment for breaks or cracks. Check that everything is clean. Replace anything that is broken or cannot be cleaned properly
8. Put the ventilator circuit together, so it is ready to use. If it is to be stored, cover the circuit with a clean towel or store it in a clean plastic bag

## Testing the Ventilator Circuit

1. Inspect the Circuit:
  - ✓ Make sure that all connections are tight
  - ✓ Make sure the humidifier and exhalation valve are put together properly
  - ✓ Check that the sensor lines are all connected
2. Do the “Disconnect Test” (Low Pressure Test):
  - ✓ Make sure the low pressure alarm setting is set correctly
  - ✓ Turn on the ventilator with the circuit connected
  - ✓ Do not connect the circuit. Wait to see if the low alarm goes off
3. If the alarm does not sound, check the alarm setting to make sure it is set correctly
4. If it still is not alarming:
  - ✓ Check the exhalation valve
  - ✓ Try another circuit or use another ventilator, if you have one. You may need to use a manual resuscitation bag to ventilate the person
  - ✓ Then contact the Ventilator Equipment Pool (VEP) right away if it is still not alarming
5. Do the “High Pressure Test”. The purpose of this test is to check that there are no holes or leaks in the tubing or connections
  - ✓ Glove one hand
  - ✓ Block the end of the trach adapter with your gloved hand and wait for the ventilator to give a breath
  - ✓ A high pressure alarm should sound after 1 - 3 breaths
  - ✓ If there is no alarm check the high pressure alarm setting to make sure it is set correctly. Also check all the connections to make sure they are tight and secure
  - ✓ If still not alarming, try another circuit or use another ventilator if available

---

**IMPORTANT! Use a manual resuscitation bag to ventilate your child. Call the Ventilator Equipment Pool (VEP) if your ventilator continues to not work.**

---

## Ventilator Safety and Troubleshooting

Below is some information to help you troubleshoot some common problems that may occur. For more information read the user manual supplied with your ventilator. Also read the “Problems and Emergency Manual”.

### What do I do if an alarm is sounding?

When a ventilator alarms you will see a warning light come on and hear a warning sound. Alarms are to alert you to a safety concern. **When an alarm goes off you need to pay attention to it right away!**

---

**IMPORTANT! Do not change the alarm settings!**

---



### Ventilator Troubleshooting Guide

Alarm	Possible Causes	Steps to Take
<p><b>Ventilator IN OP</b></p> <p>You will see a warning light and hear a warning sound.</p>	<p>There is a problem with how the ventilator is working</p>	<p>Turn the main power switch on the ventilator <i>off</i> and then <i>on</i> again. If the IN OP alarm is still alarming, <b>do not</b> use this ventilator</p> <ul style="list-style-type: none"> <li>✓ Switch to another ventilator, if available</li> <li>✓ Use manual resuscitator bag</li> <li>✓ Call VEP right away</li> </ul>
<p><b>High Pressure</b></p> <p>You will see a warning light and hear a warning sound.</p>	<ol style="list-style-type: none"> <li>1. Mucous is blocking the airway</li> <li>2. Wheezing or bronchospasm</li> <li>3. There is a respiratory infection</li> <li>4. Alarm setting is not set correctly</li> <li>5. Damaged Exhalation Balloon (valve)</li> <li>6. Kink in the tubing</li> <li>7. Water in tubing</li> <li>8. Coughing, swallowing or hiccupping</li> </ol>	<ol style="list-style-type: none"> <li>1. Suction to remove mucous.</li> <li>2. Give inhaled medicine</li> <li>3. Contact your child's healthcare professional</li> <li>4. Change alarm to proper setting</li> <li>5. Replace exhalation valve or change the circuit.</li> <li>6. Straighten the tubing</li> <li>7. Drain water</li> <li>8. If coughing, try suctioning</li> </ol>

Alarm	Possible Causes	Steps to Take
<p><b>Low Pressure/Apnea</b></p> <p>You will see a warning light and hear a warning sound.</p>	<ol style="list-style-type: none"> <li>1. Visual and auditory</li> <li>2. Leaks in the ventilator circuit (exhalation valve, humidifier, pressure line, holes in tubing)</li> <li>3. Water in the pressure line</li> <li>4. The ventilator has come off the patient's trach</li> <li>5. Leak around your child's trach and/or cuff</li> <li>6. Alarm set incorrectly</li> <li>7. Incorrect circuit</li> <li>8. Loose trach ties</li> <li>9. Loose inner cannula</li> </ol>	<ol style="list-style-type: none"> <li>1. Look and feel for any leaks. Do the "Disconnect Test"</li> <li>2. Recheck circuit and test</li> <li>3. Drain water</li> <li>4. Connect the ventilator to trach tube</li> <li>5. Reposition the patient and/or tube. May need a trach tube change. Verify the volume in the trach cuff-deflate and reinflate</li> <li>6. Set the correct alarm setting</li> <li>7. Change circuit</li> <li>8. Tighten trach ties</li> <li>9. Change inner cannula or change trach tube</li> </ol>
<b>Setting</b>	<ol style="list-style-type: none"> <li>1. Settings are incorrect.</li> <li>2. Dirty inlet filter</li> </ol>	<ol style="list-style-type: none"> <li>1. Correct the settings</li> <li>2. Replace filter</li> </ol>
<b>Power Switch Over</b>	<ol style="list-style-type: none"> <li>1. Power source has changed from AC (wall outlet) to internal or external power source.</li> <li>2. Power source has changed from external to internal</li> </ol>	<ol style="list-style-type: none"> <li>1. Make sure the ventilator is plugged in and there is power and press the reset button</li> </ol>
<b>Low Power</b>	Internal battery has drained and needs to be recharged	Operate ventilator on AC power for at least three hours

Always follow the instructions found in the ventilator manual.

---

**IMPORTANT! When a ventilator alarms, look at your child to see how they are doing. If they are not doing well, use a manual resuscitation bag to ventilate them.**

---

## Other Equipment

### Using and Cleaning the Portable Suction Unit

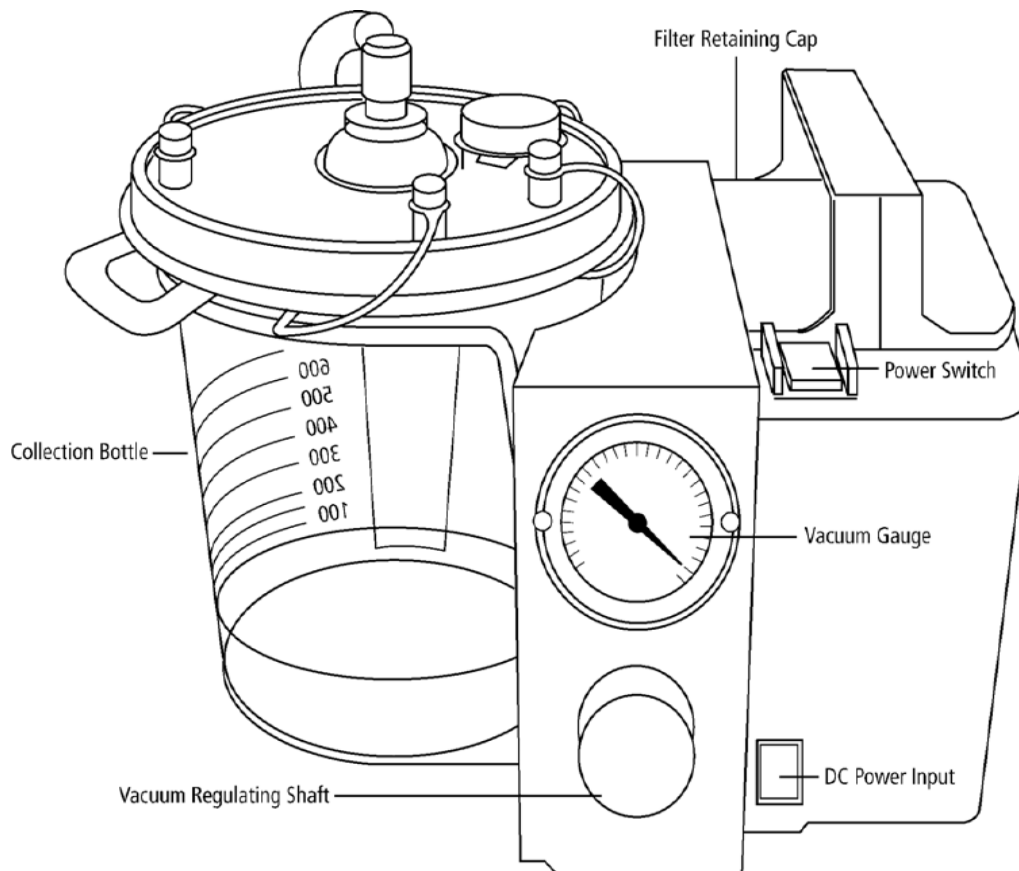

**Figure 33: Portable Suction Machine**

Reproduced with permission from Hamilton Health Sciences Centre

These units are portable so if you are going somewhere, make sure the machine's battery is fully charged and that you have all your supplies (see "Suctioning on the Go", page 36).

### How do you set the suction pressure?

The suction pressure is preset by your healthcare professional. To check the suction pressure, first turn on the unit. Then cover the open end of the connective tubing with your finger and look at the number on the gauge.

### How do I charge the battery?

Plug the portable suction machine into AC power (home wall outlet) when it is not in use. When using the machine on AC power, the on/off light will come on. When using the machine from the battery power the on/off switch **does not** light up.

### How do I clean the suction unit?

#### Daily

The canister should be emptied daily into the toilet. Wash it with soapy water and rinse well. Leave a little water in the bottom of the canister as it will stop mucous from sticking to the bottom.

#### Weekly

Clean the suction canister at least once a week.

1. You will need:
  - ✓ Mild dishwashing soap
  - ✓ White vinegar
  - ✓ Water
  - ✓ Two pails:
    - One for warm soapy water
    - One for vinegar (1 part) and water (3 parts) mix
  - ✓ Clean towel
2. Remove the short tubing from the lid. Unfasten the canister and remove the lid from the suction unit. Empty the contents into the toilet
3. Wash all parts in warm soapy water
4. Rinse with tap water to remove soap
5. Sink the pieces in one part vinegar to three parts water for **30** minutes. Rinse well and remove the extra water. Place parts on a dry towel to air dry

6. Put the tubing and canister back together. Look for any cracks and tears. Throw away and replace any broken or cracked parts
7. Wipe the machine down with a damp cloth
8. Change the connecting tubing weekly or when soiled
9. Wash hand well

### Monthly

Look at the filter and change it when it looks dirty or at least once every 2 months.

## The Manual Resuscitation Bag

The resuscitation (re-suss-i-TAY-shun) bag is a football-shaped bag that can help give breaths to a child who needs help breathing or is unable to take breaths on their own. When the bag is squeezed, the air leaves the bag and goes into the child's lungs. The air they breathe out goes out of the lungs and through a valve in the resuscitation bag. Manual resuscitation bags are also called "bags", "ambu bags" or "manual ventilators".

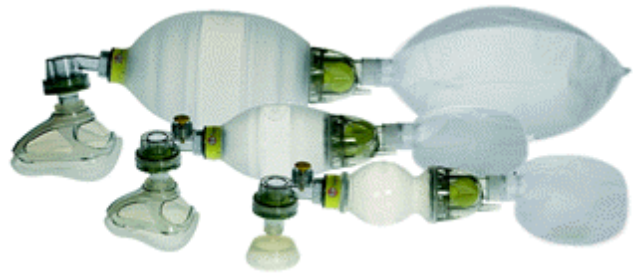

**Figure 34: Laerdal Bag**

Photo Courtesy of Hamilton Health Sciences, used with permission of Laerdal Medical Canada Ltd [www.laerdal.ca](http://www.laerdal.ca)

The manual resuscitator bag may look different from the picture.

### When do I need to use a Manual Resuscitator Bag?

- ✓ When your child is having trouble breathing
- ✓ When there is a problem with the ventilator
- ✓ With chest physiotherapy, if needed
- ✓ Before and after suctioning, if needed

## How to use the Manual Resuscitator Bag

1. You will need:
  - ✓ Manual resuscitator bag
  - ✓ Adaptor for the trach tube
  - ✓ Flex hose/tube
  - ✓ Oxygen tubing, if needed
2. Take your child off the ventilator
3. Connect the resuscitator bag to your child's trach tube
4. Squeeze the bag gently – try to deliver about 1/3 - 1/2 the volume of the resuscitator bag. Squeezing the bag should take about 1 second
5. Look at your child to make sure:
  - ✓ The chest is rising
  - ✓ They are comfortable, are awake and aware of what is happening
  - ✓ They are not turning blue
6. As soon as you finish squeezing the bag completely, release the bag to let your child breathe out. Make sure you give your child enough time to breathe out before squeezing the bag again
7. Squeeze the resuscitator bag in a regular pattern, about once every 4 - 5 seconds. Ask "Is this enough air? Do you want more?" Adjust how much and how fast and how much you are giving based on your child's needs and comfort level

---

**IMPORTANT! Never squeeze too hard on the manual resuscitator bag, as it could damage the lungs. Do not squeeze the bag too fast. If your child is not responding while suctioning, then call 911 right away.**

---

## How do I care for a Manual Resuscitator Bag?

A leak in the resuscitator bag will stop the right amount of air from filling the lungs. In order for the bag to work well it must be leak free. Every day you must do these two simple tests to make sure there are no leaks in the manual resuscitator bag.

### Test # 1

1. Wash hands well and put on gloves
2. Cover the outlet of the resuscitator bag with the palm of your gloved hand
3. With your other hand squeeze the resuscitator bag; you should feel the pressure in the bag against your hand
4. If you hear or feel a leak then tighten all the connections
5. After checking all the connections, test again for leaks by repeating steps 2 & 3.  
If it does not leak continue to *Test #2*
6. If it still leaks, you will have to replace your manual resuscitator bag. Call your respiratory healthcare professionals

### Test # 2

1. Squeeze the resuscitator bag to empty it
2. Cover the outlet of the resuscitator bag with the palm of your gloved hand
3. Release the resuscitator bag while keeping the outlet covered with your gloved hand
4. The resuscitator bag should fill up freely. If it does not, then the inlet valve maybe sticking
5. If the bag does not refill, unscrew the inlet valve assembly (pieces 6, 7 and 8 in picture) and gently loosen the valve. Then put it back together
6. Do the test over again to make sure the resuscitator bag fills freely. If it still does not fill freely, you will have to get another manual resuscitator bag. Call your respiratory healthcare professionals

### How do I clean the manual resuscitator bag?

1. Clean the bag at least once a month, or when it is dirty
2. Take apart all the pieces of the resuscitator bag
3. Fill sink/pail with warm soapy water
4. Put all the pieces in the soapy water making sure all pieces are covered for 20 minutes
5. Rinse the pieces well
6. Fill sink/pail with 1 part vinegar to 3 parts water. Soak for 20 minutes
7. Rinse well
8. Place on clean towel to dry
9. Reassemble pieces of resuscitator and do both the leak and pressure tests

The pieces go together in order from 1 to 8 from photo below.



**Figure 35: Manual Resuscitator Bag**

Photo Courtesy of Hamilton Health Sciences, used with permission of Laerdal Medical Canada Ltd [www.laerdal.ca](http://www.laerdal.ca)

**IMPORTANT! Anyone who needs a ventilator to breathe, will need a manual resuscitation bag. Those with a trach but do not need a ventilator to breathe, may also need a manual resuscitation bag.**



## Humidifiers

Humidification means to make moist or wet. Proper humidification helps keep the mucous thin and easy to cough up. There are two common types of humidifiers; the Heat and Moisture Exchanger (HME) and the pass-over humidifier.

### What is a Heat and Moisture Exchanger (HME)?

An HME is a filter-like sponge that is put onto the trach tube and stays there while your child breathes. It traps the heat and moisturize from the air that is breathed out from the lungs. On the next breath in, the air passes through the HME and becomes warm and moist.

HMEs are sometimes called an 'artificial nose'.

---

**IMPORTANT! Never dampen the HME with water.**

---

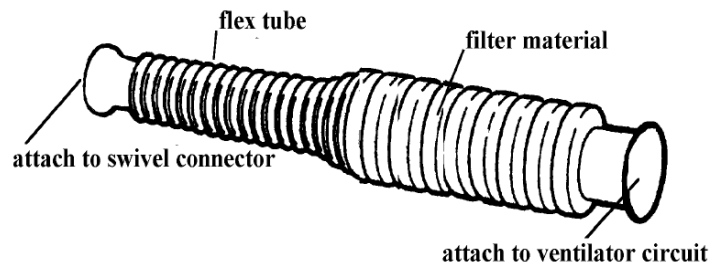

**HEAT & MOISTURE EXCHANGER**

**Figure 36: Illustration of an Heat Moist Exchanger**

Reproduced with permission from West Park Healthcare Centre  
Long-Term Ventilation, Centre of Excellence

### When do I need to change the HME?

Change the HME:

- ✓ Every day, if your child is always using one
- ✓ Every second day, if your child is using it only at night time
- ✓ When it becomes dirty

### What is a Pass-Over Humidifier?

Air from the ventilator passes over heated water, becoming warm and moist before going to the lungs.

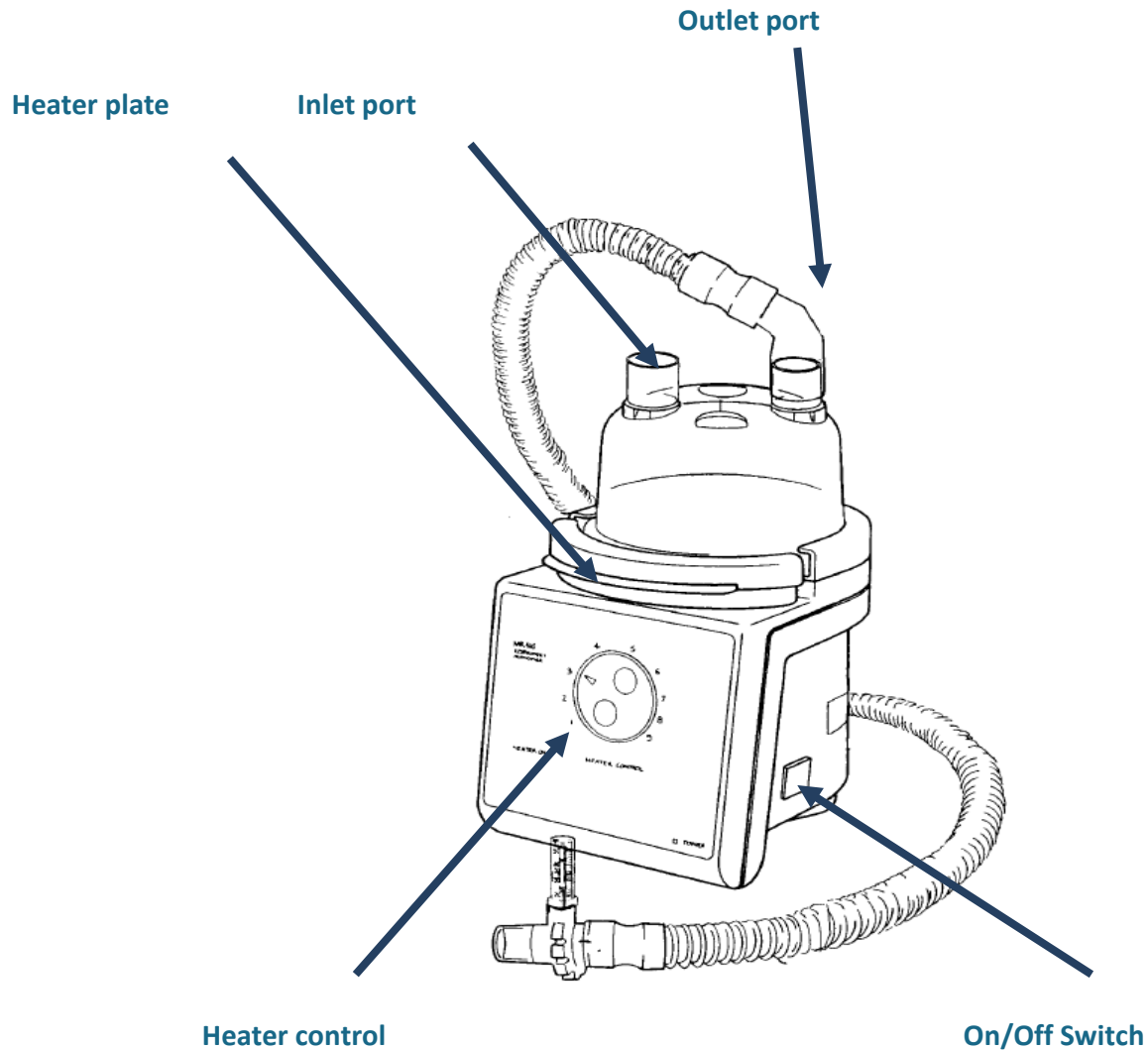

**Figure 37: Fisher Paykel MR 410 Humidifier**  
Reproduced with permission from Fisher & Paykel Health Care Inc

There are many types of pass-over humidifiers. All work in the same way, but the parts may look different. A common brand is The Fisher-Paykel humidifier. To learn more about how to care for your child's unit, read the user manual that comes with your child's equipment.

All units have:

- ✓ Three pronged wall plug for electricity
- ✓ Reservoir unit to hold the water
- ✓ Heater control that controls water temperature
- ✓ Heating plate that heats the water to the temperature that is dialled in

---

**IMPORTANT! Only use sterile distilled water. Sterile distilled water is very clean and free of germs.**

---

### Changing the Temperature

- ✓ The numbers on the heating control are “guides” for changing the temperature of the water
- ✓ The temperature will depend on your child’s comfort level and your healthcare professional’s instructions
- ✓ It takes a little time for the unit to warm up
- ✓ The water temperature can change depending on the room temperature, heaters, fans, or blankets

### How do I fill the reservoir unit with water?

The humidifier works best when you keep the water in the reservoir unit between the ‘refill’ and the ‘full’ line. Keep the water level in the reservoir at the highest water level mark. Although the water between the lines will last for a number of hours, you will have to fill or refill the humidifier often. Once the level is at the low water level mark, throw out any water left in the reservoir.

Ensure that you change the water every day and that the humidifier is in a safe place so it will not get tipped over.

---

**IMPORTANT! Never drain water from the ventilator tubing back into the reservoir. Always drain the water from the ventilator tubing into a separate container.**

---

**If the ventilator is not in use**

1. Wash your hands well
2. Use a funnel or a measuring cup
3. Disconnect the humidifier tubing and throw out the water
4. Rinse well and refill with sterile distilled water (fill to the 'full line' marking)
5. Reconnect the circuit tubing to the reservoir port opening

**If your child is on the ventilator**

You will need to know how long your child can stay off the ventilator, while breathing on their own, before doing this next step. You will need to complete all the steps in the time they are off the ventilator and breathing on their own. Ensure you have a manual resuscitation bag on hand, in case they need to be given some breaths while off the ventilator.

1. Wash your hands well
2. You will need to change the circuit to 'go around' the humidifier. You can do this by following these steps:
  - ✓ Take off the short hose going to the humidifier from the ventilator outlet port
  - ✓ Separate your child's tubing from the humidifier port
  - ✓ Connect your child's tubing directly to the ventilator outlet port. Make sure there is no water in the circuit
3. Throw out any water that is in the reservoir unit and rinse well
4. Fill the reservoir unit by using a funnel or measuring cup and fill with sterile distilled water to the "fill line" marking
5. Disconnect your child's tubing from the ventilator outlet port and reconnect it to the humidifier port
6. Re-connect the short humidifier tubing to the ventilator outlet port

### There is water in the tubing, what should I do?

Sometimes when the air leaves the humidifier it cools in the tubing and water will collect in the ventilator tubing. Water in the circuit can:

- ✓ Cause problems ventilating your child
- ✓ Cause germs to grow in the tubing which can lead to a lung infection

To remove the water from the circuit:

1. Wash your hands well
2. If the circuit has a “water trap”, let the water inside the tubing run down into the water trap. Then empty the water trap collector. **Note: you do not have to unhook the ventilator circuit when emptying the “water trap” collector**
3. Disconnect the ventilator tubing from your child at the trach site
4. Empty the short flex hose tubing by stretching it out and letting any water drain into a container
5. Remove the ventilator tubing from the humidifier outlet and drain it away from the exhalation valve
6. Drain the flex hose **away** from the exhalation manifold
7. Do not shake water from the tubing as it may spread germs
8. Attach the short flex hose to the patient's trach tube

## Inhaled Medicine

The use of inhalers or “puffers” is one way to give medicine. Often only a small amount is needed. Because the medicine is breathed into the lungs, it does not take long to work.

Puffers can be given to someone on a ventilator, by using a special chamber such as the AeroVent®.

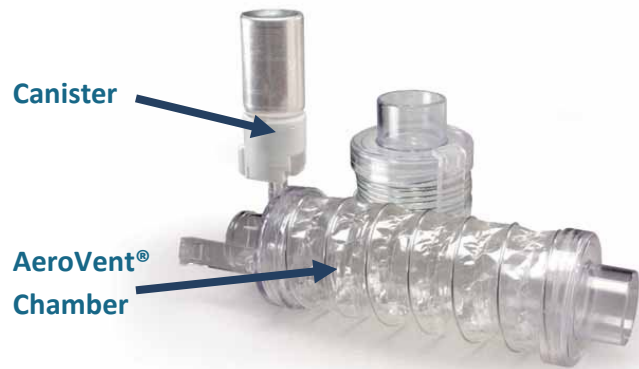

**Figure 38: Puffer Cannister and Aerovent Chamber**  
Reproduced with permission from Trudell Medical International

### How do I give a puffer to someone on a ventilator?

1. Make sure that you are using the most current puffer ordered by your doctor
2. Check the expiry dates
3. Check that there is medicine in the canister. Shake the canister slowly close to your ear to feel if it is full
4. Place the chamber into the inspiratory side of the ventilator circuit. If you have an HME on, take it off
5. Shake the canister 10 times
6. Attach the puffer canister to the chamber adaptor (AeroVent®)
7. Press down on the canister once, just as your child begins to breathe in
8. Remove the canister. Replace the cap on the inlet port, to stop any leaks
9. Wait 30 seconds. If another puff is needed, repeat steps 5-8

Clean the chamber once a week, or when you clean the ventilator circuit. Also inspect the puffer adaptor for cracking and leaks.

## Other Issues

---

### Assistive Devices Program (ADP) Funding for Respiratory Supplies

#### How do I get funding for a ventilator and other supplies?

Anyone getting a ventilator and related supplies has to apply to ADP for funding assistance. While your child is in the hospital getting ready to go home, you and your child's doctor will be asked to complete an ADP form to see if you qualify for funding.

To be approved for funding you must:

- ✓ Be an Ontario resident
- ✓ Have a valid Ontario Health Card
- ✓ Have a physical disability for at least 6 months
- ✓ Have the proper ADP forms completed by your doctor
  - A sample ADP form can be found in **Appendix A** in this Manual
  - The ADP forms need to be filled out every 3 years to renew the funding

The Assistive Device Program will pay for 100% of the cost of your child's ventilators and **some** of the accessories. ADP will pay 75% of the cost of your child's respiratory care supplies, such as:

- ✓ Custom-made masks
- ✓ Commercial masks
- ✓ Ventilator circuit supplies
- ✓ Suction units
- ✓ A manual resuscitation bag
- ✓ Disposable trach supplies

There is a limit on the amount of supplies that will be covered. To find out more about what is covered and what is not, you can read the ADP Respiratory Manual or talk to your respiratory therapist.

The Ventilator Equipment Pool (VEP) supplies your child's ventilator and ventilator circuits, battery, battery cable and humidifier. The VEP is located in Kingston Ontario. You will not need to go there to get your equipment. It will be sent to your home.

ADP is a part of the Ontario Ministry of Health & Long Term Care (MOHLTC) which is part of the Ontario government. Your ADP bill will be sent to the MOHLTC who will pay for your child's equipment. You will need to pay the remaining cost, which is 25% of the total for respiratory supplies.

### **What other funding sources are there?**

If you cannot afford to pay the remaining 25%, there are also some other options. Try the following agencies.

#### **Insurance Companies**

- ✓ Extended Health Care (EHC) Insurance through workplace or privately  
e.g. Ontario Blue Cross

#### **Government assistance programs**

- ✓ Ontario Disability Support Program (ODSP)
- ✓ Ontario Works
- ✓ Assistance for Children with Severe Disabilities (ACSD)

If you are interested in finding out more about other funding sources, contact your CCAC case worker, social worker or physician who will help you find out what is best for you.



## The Ventilator Equipment Pool

### What is the Ventilator Equipment Pool (VEP)?

The VEP is a central place where the ventilators are kept. VEP is part of Assistive Devices Program (ADP). The VEP supplies your child's ventilator and related equipment for those who are approved by ADP.

### Getting your Ventilator

Once ADP approves your request they inform VEP. VEP will then send you the equipment that your doctor has ordered.

### Ventilator Circuits

VEP will send you two ventilator circuits for every ventilator you are approved for. You will get 2 new circuits every 2 years.

### The equipment is to be returned to VEP if you:

- ✓ No longer need it
- ✓ Are not approved for funding
- ✓ Are admitted to hospital and are not coming home for quite a while
- ✓ Are living in Long Term Care

The VEP does not give ventilators for use in long term care facilities. Patients entering these facilities must tell VEP that their status has changed.

### Who will service and repair the ventilator?

The ventilator will need regular service. Service and repairs are done by the VEP at no cost to you. It is important to make sure that your ventilator receives the service when it should. Read the manual that came with the ventilator for more information.

VEP will **not** pay for equipment that is lost, stolen or damaged through neglect or abuse.

- ✓ When it is time for service, the VEP will call and to make arrangements to pick up the ventilator
- ✓ The replacement ventilator will be sent from Kingston and it will become your new ventilator. You will keep this 'new' ventilator until the next time your ventilator needs to be sent back for service

- ✓ Make sure the ventilator settings and alarm limits are set properly, before using the new ventilator

### I am having problems with my child's ventilator. Who do I call?

If you are having problems with your child's ventilator first look at the manual and the trouble shooting section in this book. **Your home care company may be able to help you to find out what the problem might be.** If you are still having problems with the ventilator, then contact your equipment provider.

Call your home care company if you have problems with your child's ventilator circuit, such as the tubing and connectors.

---

**IMPORTANT! Call your ventilator equipment provider if you are having trouble with your child's ventilator.**

---

#### My ventilator equipment provider is:

**VEP**

VEP phone number is **1-800-633-8977** or **1-613-548-6156**.  
Follow the prompts on the message for service after business hours. A respiratory therapist is available 24 hours a day.

**My ventilator supply provider's name is:**

\_\_\_\_\_

Phone number is: \_\_\_\_\_

## References

---

Department of Critical Care Nursing. (2002). *Passy-Muir® trach speaking valve*. Ohio: The Ohio State University Medical Center.

Department of Critical Care Nursing. (2007). *Tracheostomy suctioning*. Ohio: The Ohio State University Medical Center.

Department of Inpatient Nursing. (2005). *Changing tracheostomy ties*. Ohio: The Ohio State University Medical Center.

Department of Inpatient Nursing. (2005). *Reinsertion of a tracheostomy tube*. Ohio: The Ohio State University Medical Center.

Department of Inpatient Nursing. (2005). *Tracheostomy care. Disposable inner cannula*. Ohio: The Ohio State University Medical Center.

Department of Inpatient Nursing. (2005). *Tracheostomy tubes*. Ohio: The Ohio State University Medical Center.

Department of Inpatient Nursing. (2007). *Tracheostomy care with non-disposable inner cannula*. Ohio: The Ohio State University Medical Center.

Division of Nursing: The James Cancer Hospital and Solove Research Institute. (2004). *Trach cuffs*. Ohio: The Ohio State University Medical Center.

Young, C.S. (1984) Recommended guidelines for suction. *Physiotherapy* 70: 106-108

# Pulmonary Clearance Techniques

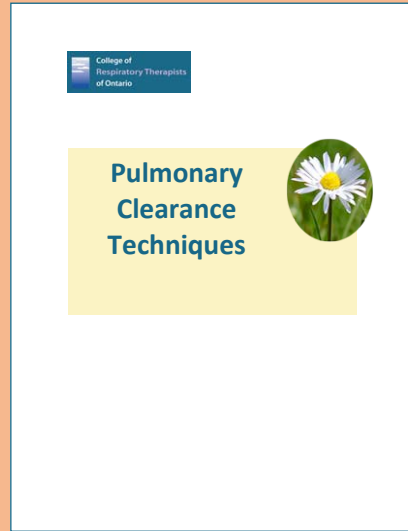

# Pulmonary Clearance Techniques

Notes

---

---

---

---

---

---

---

---

---

---

---

---

---

---

---

---



College of  
Respiratory Therapists  
of Ontario

# Pulmonary Clearance Techniques





# Introduction

---

A strong cough is important so you can remove mucous from your lungs. If you have weak muscles you may not be able to cough out your mucous. Perhaps you cannot take a deep breath in. Perhaps you cannot breathe out with enough force to bring up the mucous. For a strong cough you need two things:

- ✓ To be able to completely fill your lungs and
- ✓ To be able to breathe out forcefully

There are ways to help you if your muscles are too weak. This section lists several methods and exercises to help you cough. If you use these exercises daily, you will be able move the mucous up from the airway into your throat or mouth, where it can be suctioned out.

## **Pulmonary Clearance Techniques may improve:**

- ✓ The amount of air you can breathe into and out of the lungs
- ✓ Coughing and speaking
- ✓ The amount of oxygen getting to the body

## **Pulmonary Clearance Techniques may prevent:**

- ✓ The air sacs from collapsing
- ✓ Lung infections

## **Common Techniques**

- ✓ Breath Stacking
- ✓ Assisted Cough Technique
- ✓ Postive Expiratory Pressure (PEP)
- ✓ Cough Assist Device

All these techniques have one thing in common. They all need someone to help you.



# Breath Stacking

---

Breath stacking is a breathing exercise that can help people who have breathing problems due to muscle weakness or poor chest movement.

You will need 2 manual resuscitation bags. You need one in case of emergencies where you need to use it to manually ventilate. The second one will be changed to become your Breath Stacking Bag. The bag used for breath stacking prevents the person from breathing out. The bag used for breath stacking should be clearly marked "Not for resuscitation"

## Making a Breath Stacking Bag

- ✓ Manual resuscitator bag
- ✓ One-way valve
- ✓ Extension tube
- ✓ Either a mask or mouthpiece
- ✓ Nose clips

## How is breath stacking done?

1. Have the person sit comfortably. They can lean back a bit, but they should not be slouching
2. Put on nose clips
3. Look at the person being bagged and try to squeeze the bag as the person breathes in
4. Have the person take a deep breath in
5. Have them place their lips around the mouthpiece or hold the mask on their face
6. Have the person breathe in the air as the bag is squeezed
7. Ask them to try to keep breathing in more air, as the bag is squeezed a second time
8. They should fill their lungs as full as possible and feel a stretch across the front of their chest.
9. Have them hold the air in as long as possible before letting it go out. Use the air they are breathing out to cough.
10. Regular breath stacking is good to do even if it is not used with an assisted cough. You may find that breath stacking with an assisted cough is only needed once a day.

When breath stacking is done right, it should **not** result in:

- ✓ dizziness
- ✓ chest discomfort
- ✓ chest pain

---

**IMPORTANT! If you encounter dizziness, chest discomfort or chest pain, stop the breath stacking exercise and rest.**

---

## How often should breath stacking be done?

Each time you do this exercise, do it 3 to 5 times. Breath stacking should not be done more than every ten minutes. Breath stacking should be done 3 to 5 times a day.

## Assisted Cough Method

---

Having someone push on your abdomen (belly) just when you are trying to cough out is called the Assisted Cough method. If you are not able to have someone push on your abdomen, then they could push on your rib cage as you try to cough.

---

**IMPORTANT! If you are sitting when this is done be sure that the chair will not tip over.**

---

### When should assisted cough be done?

Doing breath stacking and assisted cough method on a full stomach may cause you to vomit. To prevent this from happening do it:

- ✓ Before eating a meal
- ✓ 2 hrs after eating a meal
- ✓ Bedtime

### Helpful Hints for Children

Children 2 to 6 years of age are often not able to take a deep breath in while you insert the mouthpiece or put the mask on. Ask them to pretend to blow out candles. This will help them to empty their lungs. Try to catch them on their next breath-in and say “take a deep breath, and another one, and another one”. Make eye contact with them the whole time. Then tell them to “cough” or “breathe out” when they exhale.

## Cough Assist Device

The Cough Assist Device helps you get rid of mucous by trying to create a stronger cough. You hold a mask on the face and the machine delivers a slow pressure increase when you breathe in. Then it is followed by a rapid 'suction' effect. The slow breath-in followed by a quick breath out, creates a cough.



Figure 1: Cough Assist Device.

<http://www.coughassist.com/default.asp>

Reproduced with permission of Philips Respironics

You can use either a mask or a mouthpiece with the Cough Assist Device. Small children and people with muscle weakness will have trouble keeping a seal on a mouthpiece, so will need to use a mask. When using a mask you will need a good seal. If using a mask, be sure you have good head and neck support, such as against a head rest on a wheelchair.

## How do I give a Cough Assist Treatment?

1. You need two people to do the Assisted Cough technique
2. Have the patient sit comfortably with good head and neck support. They can be in bed, with their head partially supported.
3. Check that the suction unit is working and ready
4. Check that the pressure settings on the Cough Assist Device are what was ordered
  - Turn on the unit
  - Seal the mask with your hand while you operate the Cough Assist Device
  - Look at the pressure settings on both the IN and EX side

5. Make eye contact with the patient
  - Have the patient breathe out fully, then place the mask on their face just as they begin to breathe in -OR-
  - Have the patient breathe in and hold their breath as you place the mask on their face
6. Move the lever to IN side and hold while you call out clearly “IN, IN, IN”
7. Quickly switch lever to EX side and call out “Cough, Cough, Cough”
8. Remove mask right away
9. Suction, if needed

## Young Children

Children need some time to become familiar with the sounds of the device. Let them play with the mask and push the buttons so they can hear the sounds. When they are comfortable with the sounds, let them try one assisted breath. Be patient. It will take some time for them to be comfortable with the exercise.

## Other Pulmonary Clearance Techniques

---

### Chest Physiotherapy

Chest physiotherapy is a physical technique of removing secretions with the use of clapping, percussion, vibrations and/or postural drainage. Talk to your healthcare professional to learn more about this technique.

### Positive expiratory pressure devices (PEP)

The PEP device is a small hand-held device where you breathe out against a pressure.

## Clinical References

---

Miske LJ, Hickey EM, Kolb SM, Weiner DJ, Panitch HB. Use of the mechanical in-exsufflator in pediatric patients with neuromuscular disease and impaired cough. *Chest*. 2004;125:1406-1412.

Finder J. *Overview of airway clearance technologies*. July 2006. Available at: [http://www.rtmagazine.com/issues/articles/2006-07\\_06.asp](http://www.rtmagazine.com/issues/articles/2006-07_06.asp). Accessed August 12, 2007.

Bach JR. Mechanical insufflation/exsufflation: has it come of age? A commentary. *Eur Respir J*. 2003;21:385-386.

Finder JD, Birnkrant D, Farber CJ, et al. Respiratory care of the patient with Duchenne muscular dystrophy: ATS consensus statement. *Am J Respir Crit Care Med*. 2004;170:456-465.

Chatwin M, Ross E, Hart N, Nickol AH, Polkey MI, Simonds AK. Cough augmentation with mechanical insufflation/exsufflation in patients with neuromuscular weakness. *Eur Respir J*. 2003;21:502-508.

Tzeng AC, Bach JR. Prevention of pulmonary morbidity for patients with neuromuscular disease. *Chest*. 2000;118:1390-1396.

McCool DF, Rosen MJ. Nonpharmacologic airway clearance therapies: AACP evidence-based clinical practice guidelines. *Chest*. 2006; 129:250-259.

Winck JC, Goncalves MR, Lourenco C, Viana P, Almeida J, Bach JR. Effects of mechanical insufflation-exsufflation on respiratory parameters for patients with chronic airway secretion encumbrance. *Chest*. 2004;126:774-780.

## Resources

Ottawa Rehabilitation Center, [www.rehab.on.ca](http://www.rehab.on.ca)



# Education Checklists

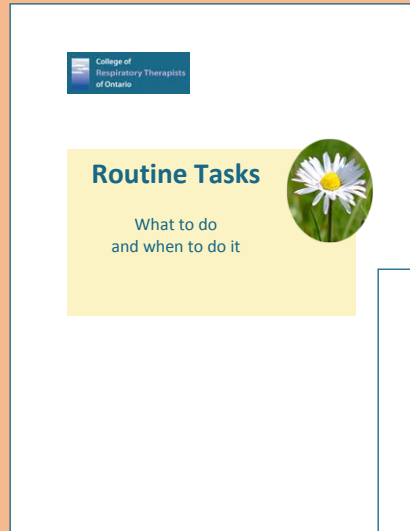







College of  
Respiratory Therapists  
of Ontario

# Routine Tasks

What to do  
and when to do it





Task	Daily	Weekly	Monthly
Stoma care	✓		
Trach care	✓		
Clean reusable inner cannula or replace disposable inner cannula	✓		
Clean speaking valves	✓		
Clean suction canister – warm soapy water	✓		
Change HME: if it is used all the time	✓		
Ventilator plugged in	✓		
Test ventilator alarms	✓		
Check ventilator settings	✓		
Test the ventilator circuit	✓		
Test the manual resuscitator bag, if used often	✓		
Make sterile distilled water	Every 2-3 days		
Test the manual resuscitator bag – if not used frequently		✓	
Clean suction canister in vinegar and water		✓	
Change HME: if being used only at night time		✓	
Wipe down suction machine		✓	
Change suction tubing		✓	
Clean and test manual resuscitation bag		✓	
Clean ventilator circuit		✓	
Clean puffer chamber		✓	
Clean humidifier		✓	
Unplug ventilator and wipe with a damp cloth		✓	
Check and order supplies		✓	
Change bacterial filter in breathing circuit			✓
Clean or replace inlet filters (see manual)			✓
Discharge and recharge ventilator internal battery			✓
Discharge and recharge the D/C External battery			✓
Change suction filter			Every 2nd month
Ventilator preventative maintenance by VEP or other equipment provider	As required by equipment provider		
Update the ventilator equipment pool with any changes	As changes occur		





College of  
Respiratory Therapists  
of Ontario

# My Education Checklist and Learning Log





## Introduction to Checklist

Below is a list of learning goals. It is important that all caregivers take part in learning how to care for someone who is ventilated. You will learn from many different healthcare professionals. This checklist is a guide to make sure that everything you need to know is covered. At any time, if you feel you need to redo something, or are unsure of something, just ask. Your healthcare professionals are eager to help you.

**Individual's Name:** \_\_\_\_\_

## Learning Objectives

At the completion of the training, the participant will be able to...

Individual Care	Date	Initials	Caregiver Initials
1. Describe in general terms normal anatomy and physiology of the respiratory system: <ul style="list-style-type: none"> <li>- How we breathe</li> <li>- Humidification</li> <li>- Upper airway anatomy and placement of a tracheostomy</li> <li>- What is different with a tracheostomy</li> <li>- Location and role of vocal cords</li> <li>- Explain why an individual with a trach tube might not be able to speak</li> </ul>			
2. Describe how changing body position or eating a meal can affect breathing			
3. Demonstrate safe technique for: <ul style="list-style-type: none"> <li>- Bathing</li> <li>- Feeding/Eating</li> <li>- Dressing</li> </ul>			
4. Explain the importance of drinking water and using a humidifier to manage secretions			
5. Describe why heart rate or breathing rate may change with activity or illness			



6. Describe possible signs and symptoms of a chest infection and the steps to take if there is an infection			
7. Explain the importance of proper hand hygiene and how the use of gloves and a mask can prevent the spread of infection			
8. Explain the purpose of breath stacking			
9. Describe what equipment is needed for breathstacking			
10. Demonstrate how to do the breathstacking technique			
11. Describe the plan for follow-up care			
12. Explain the role of the family physician in the care of the individual			

<b>Home Equipment</b>	<b>Date</b>	<b>Initials</b>	<b>Caregiver Initials</b>
1. Identify the hazards and safety implications for someone with a trach due to a loss of the protective mechanisms of the upper airway			
2. Identify home environment hazards			
3. Determine if there are sufficient number of grounded plugs			

<b>Inhaled Medication</b>	<b>Date</b>	<b>Initials</b>	<b>Caregiver Initials</b>
1. Explain the function, dose and frequency of individual-specific Metered Dose Inhalers (MDI)/puffers			
2. Demonstrate/explain how to give an MDI/puffer with the ventilator			

<b>Humidification System</b>	<b>Date</b>	<b>Initials</b>	<b>Caregiver Initials</b>
1. Explain the importance of humidification			
2. Demonstrate when and how to use an heated moister exchanger (HME)			
3. Demonstrate how to use and clean a passover humidifier			

<b>Tracheostomy Care</b>	<b>Date</b>	<b>Initials</b>	<b>Caregiver Initials</b>
1. Define tracheostomy			
2. Explain why an individual might need a tracheostomy			
3. Name the parts of the tracheostomy tube			
4. Describe stoma care			
5. Describe how to prevent and manage skin breakdown			
6. Describe how to recognize and treat skin problems around stoma (e.g. granulomas) and neck			
7. Demonstrate how to clean the stoma and describe what equipment is needed			
8. Demonstrate correct inflation and deflation of a cuffed tracheostomy tube			
9. Explain the purpose of an inner cannula			
10. Demonstrate how to insert or remove an inner cannula			
11. Explain how a trach tube could become blocked and how to clear it			
12. Describe how to clean and take care of the trach equipment			
13. Demonstrate how to change the tracheostomy ties or holder			
14. Main role: Changes outer cannula, holds cannula in place until helper is finished securing the trach ties, assesses and maintains airway			

15. Helper role: removes ties, cleans neck and stoma, positions and holds person for tube change, suction (tip or measured), secures ties when tube is change			
16. Describe and demonstrate the emergency replacement of the trach tube			
<p>17. Trach Tube Change:</p> <ul style="list-style-type: none"> <li>✓ Demonstrates Helper role on patient             <ul style="list-style-type: none"> <li>- Practice # 1</li> <li>- Practice # 2</li> <li>- Practice # 3</li> </ul> </li> <li>✓ Demonstrates Main role on patient             <ul style="list-style-type: none"> <li>- Practice # 1</li> <li>- Practice # 2</li> <li>- Practice # 3</li> </ul> </li> <li>✓ Demonstrates Solo trach change competently             <ul style="list-style-type: none"> <li>- Practice # 1</li> <li>- Practice # 2</li> <li>- Practice # 3</li> </ul> </li> </ul>			

<b>Speaking Valves and Other Adjuncts</b>	<b>Date</b>	<b>Initials</b>	<b>Caregiver Initials</b>
1. Describe how a speaking valve works and when to use it			
2. Describe how to clean and take care of the speaking valve			
3. Explain the importance of cuff deflation before using a speaking valve, if applicable			
4. Trach Mask			
5. Oxygen therapy			
6. Explain the need for a specialty trach tube and how to order one			

<b>Oximeter</b>	<b>Date</b>	<b>Initials</b>	<b>Caregiver Initials</b>
1. Explain what parameters the oximeter measures including the waveform, and perfusion index			
2. Demonstrate how to get a good saturation and heart rate reading			
3. Demonstrate correct application of probe			
4. Explain when to use oximeter; asleep and/or unattended			
5. Identify oximeter assessment abilities			
6. Demonstrate how to set correct alarm settings; low and high settings for saturation and Heart Rate (HR)			
7. Describe when and how often to change probe, every 4 hours and as needed (PRN)			
8. Systematic troubleshooting (refer to user guide)			
9. Explain the battery power requirements			
10. Explain the routine monitor maintenance			

<b>Suctioning</b>	<b>Date</b>	<b>Initials</b>	<b>Caregiver Initials</b>
1. Explain why an individual might need suctioning			
2. Identify the appropriate interventions for secretions that are: dry and thick, yellow or green, blood tinged			
3. Explain the purpose of suctioning			
4. Identify the characteristics of secretions: colour, consistency, amount, and odour and why it is important			
5. Demonstrate how to correctly set up the suction equipment			
6. Explain why it is important to use two gloves when suctioning			
7. Demonstrate clean suctioning technique including asking the individual for direction before and during suctioning			

8. Explain why suctioning should be done only when needed, trying to avoid over suctioning or frequent suctioning			
9. Explain what to do if blood is suctioned from the trachea, and explain what difference it might make if the individual takes blood thinners			
10. Explain how to troubleshoot the suction unit			
11. Describe correct disposal of dirty suction equipment including suction catheters and gloves			
12. Demonstrate how to: <ul style="list-style-type: none"> <li>- Tip suction</li> <li>- Tube suction</li> <li>- Deep suction</li> </ul>			
13. Demonstrate how to stock the portable suction bag for use outside the home			

Manual Ventilation	Date	Initials	Caregiver Initials
1. Demonstrate how to properly connect and disconnect an individual from a ventilator			
2. Demonstrate when and how to use the manual resuscitation bag			
3. Demonstrate how to test the manual resuscitation bag for proper functioning			
4. Demonstrate how to properly clean the manual resuscitation bag			
5. Demonstrate how to add oxygen when using the manual resuscitation bag			

Ventilator Care	Date	Initials	Caregiver Initials
1. Describe the purpose of a ventilator and when an individual might need one			
2. Demonstrate what needs the check-out procedure when starting the ventilator at the bedside: high and low pressure testing			
3. Demonstrate what needs to be turned on and checked when starting the ventilator on the wheelchair			
4. Demonstrate how to change the water in the humidifier, and describe what kind of water is used in the humidifier			
5. Explain what needs to be plugged in when the wheelchair ventilator is not in use			
6. Demonstrate how and when to make ventilator setting changes, including oxygen			
7. Demonstrate how to check the ventilator high and low pressure alarms			
8. Describe the kind of situations that make the low-pressure alarm sound and what to do for the individual			
9. Describe the kind of situations that make the high-pressure alarm sound and what to do for the individual			
10. Describe the kind of situations that make the power switch over alarm sound and what to do for the individual			
11. Describe the kind of situations that make the ventilator inoperative alarm sound and what to do for the individual			
12. Describe all ventilator alarms including high and low pressure alarms			
13. Describe what to do when there is a ventilator IN OP alarm			
14. Demonstrate how to assemble and disassemble the ventilator circuit			

15. Demonstrate changing the ventilator circuit and checking the ventilator after changing the circuit			
16. Describe how to use a PEEP valve (if applicable)			
17. Demonstrate how to assemble and disassemble the PEEP valve (if applicable)			
18. Demonstrate how to clean the ventilator circuit			
19. Describe how and when to clean the ventilator circuit and change the filters			
20. Demonstrate how to check the external and internal battery			
21. Discuss how long a battery should last			
22. Discuss how often to check and discharge the battery			
23. Demonstrate how to charge and discharge the battery			

Emergency Management	Date	Initials	Caregiver Initials
1. Describe the emergency plan, i.e. when to call 911			
2. Describe the role of the home care company in an emergency			
3. Describe the role of the acute care hospital in an emergency or power failure situation			
4. Describe the role of Hydro and the Fire Department in an emergency			
5. Explain the emergency preparedness plan, including the procedure during a power failure			
6. Explain what to do if the individual has an obstructed air passage, such as how to clear the airway			
7. Explain how to identify and manage someone in respiratory distress			
8. Describe/demonstrate correct actions for each of the following situations: <ul style="list-style-type: none"> <li>- Accidental decannulation</li> <li>- Mucous Plug</li> <li>- Trauma to stoma area</li> </ul>			
9. Identify and indicate how to contact local emergency resources			
10. Identify what information needs to be conveyed to emergency personnel			
11. Ensure family is provided with emergency contact list			
12. Caregivers are trained in CPR			
13. Demonstrate manual ventilation of a tracheostomy			
14. Demonstrate how to ventilate should the trach come out and you can't replace it			



Funding and Equipment Supply	Date	Initials	Caregiver Initials
1. Explain the role of Assistive Devices Program (ADP) in funding the equipment and supplies			
2. Explain the role of the Ventilator Equipment Pool (VEP) and how to contact them			
3. List the equipment provided by the VEP			
4. List equipment not provided by the VEP			
5. Explain the role of the home care company and how and when to contact them			
6. List the supplies that come from the home care company, how to place an order and explain funding			
7. List the supplies <u>not</u> covered by ADP that the individual is responsible for			
8. Describe how to safely store equipment			
9. Describe when to discard equipment (please refer to guidelines in the <i>Ventilation &amp; Tracheostomy Care</i> section)			

Healthcare Provider Name/Designation	Signature	Initials

## Best Time for Education Sessions

Check off morning (M), afternoon (A) or evening (E) in the chart below for the best time for our education sessions.

Caregiver	Relationship to Patient	Su	Mo	Tu	We	Th	Fr	Sa

## Additional Comments

---



---



---



---



---



---



---



---



---



---

**I understand that, although I may complete this education checklist, I am not being certified to do any of the acts described. Any actions that I take following this training will be done under the direction and responsibility of the patient or their authorized agent.**

**Caregiver Signature:** \_\_\_\_\_ **Date:** \_\_\_\_\_

Facility Name: \_\_\_\_\_

Address: \_\_\_\_\_

**Instructor Signature:** \_\_\_\_\_ **Date:** \_\_\_\_\_

Facility Name: \_\_\_\_\_

Address: \_\_\_\_\_



College of  
Respiratory Therapists  
of Ontario

# Oximeter Teaching Checklist





This is a checklist for the healthcare professional to use when reviewing the oximetry equipment with the caregiver. Verify receipt of the equipment, probes, the reference manual and user guide.

<p><b>1. Ensure all probes and cables are working by testing them on either yourself or patient. Ensure caregiver performs the same test on the child</b></p> <p><b>2. Review and explain parameters:</b></p> <ul style="list-style-type: none"> <li><input type="checkbox"/> Spo2</li> <li><input type="checkbox"/> Heart rate</li> <li><input type="checkbox"/> Waveform</li> <li><input type="checkbox"/> Perfusion Index</li> </ul> <p><b>3. Review and explain alarms (must be ordered by physician):</b></p> <ul style="list-style-type: none"> <li><input type="checkbox"/> Low Saturation</li> <li><input type="checkbox"/> High Saturation (if a patient is not on oxygen this can be turned off as ordered by physician)</li> <li><input type="checkbox"/> Low Heart Rate</li> <li><input type="checkbox"/> High Heart Rate</li> <li><input type="checkbox"/> Explain that adjusting alarms must have a physician's order</li> <li><input type="checkbox"/> Demonstrate how to adjust alarms (in case physician orders it to be made at home)</li> </ul>	<p><b>4. Review and explain:</b></p> <ul style="list-style-type: none"> <li><input type="checkbox"/> Power indicator light</li> <li><input type="checkbox"/> Battery indicator (four shaded segments = fully charged)</li> <li><input type="checkbox"/> Heart rate volume</li> <li><input type="checkbox"/> Alarm volume</li> <li><input type="checkbox"/> Backlight</li> <li><input type="checkbox"/> Lock function</li> <li><input type="checkbox"/> Alarm silence button – one for two min silence; three quick will silence indefinitely – press once to reset to normal function</li> </ul> <p><b>5. Review battery power:</b></p> <ul style="list-style-type: none"> <li><input type="checkbox"/> Needs 3.5 hours to completely charge internal battery</li> <li><input type="checkbox"/> Battery life – 24 hours if completely charged (if backlight is on the internal battery lasts 12 hours)</li> </ul> <p><b>6. Troubleshooting:</b></p> <ul style="list-style-type: none"> <li><input type="checkbox"/> Review the troubleshooting guide in the technical reference manual page 3-1</li> </ul> <p><b>7. Contact information to tell family/caregiver:</b></p> <ul style="list-style-type: none"> <li><input type="checkbox"/> Contact Ventilator Equipment Pool (VEP)</li> <li><input type="checkbox"/> Explain to the caregiver when equipment is no longer needed and physician has discontinued use, caregiver to contact VEP to return</li> </ul>
--	---

---

Caregiver Signature and Date

---

RRT Signature and Date



# Troubleshooting









College of  
Respiratory Therapists  
of Ontario

# Troubleshooting Guide





# Problems and Solutions

---

When caring for patients on long term ventilation, you need to be aware of problems that may arise. The problems may be related to what is happening with the patient or what is happening with the ventilator.

## Problems Related to the Patient

Whenever there is a problem, the first thing you need to do is look at the patient to see if they are having any breathing problems. Patients will try to tell you if they are having trouble breathing, are in pain, or need something. Every person is different, but common ways of getting your attention include:

- ✓ Clicking their tongues
- ✓ Making unusual sounds
- ✓ Triggering an emergency bell or a ventilator alarm

If the patient is having trouble breathing they may look:

- ✓ Short of breath
- ✓ Pale, dusky or blue
- ✓ Scared or frightened

Consider using a baby monitor alarm, so others can hear if there is a problem.

---

**IMPORTANT! If the patient cannot speak or communicate, then they are not getting any air. If this happens, manually ventilate using the resuscitation bag. A patient with a speaking valve who cannot talk usually means they are not getting any air.**

---

### What do I do if the patient is in distress?

1. Try to find out what the problem is by asking the patient “What is the problem?” or “Are you getting enough air?” or “Do you need to be suctioned?”
2. Manually ventilate using a resuscitation bag
3. Use oxygen with the resuscitation bag, if needed

4. If the patient has nodded yes to “Do you need to be suctioned?” then suction them immediately
5. Call out for help to anyone who can hear you, such as a family member. Phone 911 or your regional emergency number for an ambulance
6. Keep on manually ventilating the patient until help arrives
7. Stay with the patient. Tell the patient what is happening, and that help is on the way
8. Once emergency support has arrived explain the problem to the attendants

The following **table** lists problems and some steps to take to solve them. If you at any time do not feel that you are able to correct the problem, do not wait to call for help.

Problem	What to do
<ul style="list-style-type: none"> <li>- Blocked Airway</li> <li>- Choking on food</li> <li>- Mucous in the airway</li> </ul>	<ul style="list-style-type: none"> <li>✓ Suction to remove mucous or food</li> <li>✓ Manually ventilate using the resuscitation bag</li> <li>✓ If there is an inner cannula, change it</li> </ul>
<p>Patient is “not getting enough air”</p>	<ul style="list-style-type: none"> <li>✓ Manually ventilate using the resuscitation bag</li> <li>✓ Suction to remove anything that may be blocking the airway</li> <li>✓ Tighten all ventilator tubing connections</li> <li>✓ Check that there is no leak in the system</li> <li>✓ Make sure the humidifier hose is connected</li> <li>✓ Make sure the ventilator settings are set correctly</li> <li>✓ Check to see if there is a trach tube cuff leak</li> <li>✓ If oxygen is being used, check that the oxygen supply is set up correctly</li> <li>✓ If patient is short of breath right after activity, allow them to settle or rest a little to see if there is improvement</li> <li>✓ The patient may need their bronchodilator (puffer); if it is part of the care plan, then give the dose now</li> <li>✓ If you have an oximeter, check the reading</li> <li>✓ If there is a cuffed trach tube, make sure the cuff is properly inflated</li> </ul>

Problem	What to do
Problem with the Trach Tube	<ul style="list-style-type: none"> <li>✓ Make sure the ventilator tubing is not pulling on the trach tube</li> <li>✓ Reposition the patient so the tube is not being pulled on</li> <li>✓ Reposition the head and neck</li> <li>✓ If on the ventilator, and you hear air coming from around the trach, you may have a trach tube cuff leak</li> <li>✓ Check that the inner cannula is not blocked and is locked in place</li> <li>✓ Check that the trach ties are tied securely, but not too tight</li> <li>✓ May need a trach tube change</li> </ul>
Possible infection: <ul style="list-style-type: none"> <li>– Stoma is red, swollen or painful to touch</li> <li>– Mucous is yellow or green</li> <li>– There is more mucous</li> <li>– You need to suction more often</li> <li>– Needs more puffer medicine</li> <li>– Has a fever or chills</li> <li>– Is not feeling well and is really tired</li> <li>– Oximeter reading, if you have one, is low</li> </ul>	<ul style="list-style-type: none"> <li>✓ If you have an action plan that the doctor has given you, follow that</li> <li>✓ Call the doctor or healthcare professional right away</li> </ul>
The patient is very anxious	<ul style="list-style-type: none"> <li>✓ Instill 2-5 mls of normal saline into trach and apply manual resuscitator or ventilator for a few breaths</li> <li>✓ Use <i>Breath Stacking and Cough Assist</i> techniques to move any mucous up the airway</li> <li>✓ Try to remain calm and tell them what you are doing to solve the problem</li> <li>✓ Have patient do relaxation exercises</li> <li>✓ If necessary, give medication as ordered</li> </ul>

Problem	What to do
<p>There is a lot of mucous and it is difficult to suction it all out</p>	<ul style="list-style-type: none"> <li>✓ Suction                             <ol style="list-style-type: none"> <li>1. Lubricate the suction catheter with water and try suctioning again</li> <li>2. Use manual resuscitation bag to deliver 3-5 breaths</li> <li>3. Change the inner cannula, if there is one</li> <li>4. Suction</li> <li>5. Repeat steps 1-4, if needed</li> </ol> </li> <li>✓ Use <i>Pulmonary Clearance Techniques</i> – such as Breath Stacking. This will help move the mucous up so it can be suctioned out</li> <li>✓ Moving often will help a patient cough up their mucous. You can turn the patient every 1-2 hours or have them sit in a chair several times a day</li> <li>✓ If you have learned how, change the trach tube</li> <li>✓ Call 911 if airway is still blocked</li> </ul>
<p>The trach tube has fallen out and the patient is not having any trouble breathing</p>	<ul style="list-style-type: none"> <li>✓ Try to put the trach tube back in. Only try this once. If this does not work, get a new trach tube to insert                             <ol style="list-style-type: none"> <li>1. Completely deflate the cuff of the new trach tube</li> <li>2. Lubricate the trach tube with water soluble lubricant</li> <li>3. Insert obturator into the new trach tube</li> <li>4. Slide new trach tube into stoma, but do not force</li> <li>5. <b>Remove the obturator</b></li> <li>6. Insert the inner cannula, if there is one</li> <li>7. Reinflate cuff, if there is one</li> <li>8. Try to ventilate with a manual resuscitation bag</li> <li>9. Check that the chest is rising and falling with each breath</li> <li>10. Place patient back on the ventilator</li> <li>11. Check patient to make sure they are okay</li> </ol> </li> <li>✓ If you are <b>not</b> able to <b>re-insert the trach tube</b>:                             <ol style="list-style-type: none"> <li>1. Use a manual resuscitation bag with mask and ventilate the patient</li> <li>2. <b>CALL 911</b></li> <li>3. Contact your doctor and your respiratory therapist</li> </ol> </li> </ul>

Problem	What to do
The patient is in pain	<ul style="list-style-type: none"> <li>✓ Determine the type and location of the pain. For example; is the pain with coughing, swallowing or only on breathing in?</li> <li>✓ Try to reposition the patient</li> <li>✓ Give pain medicine, if ordered</li> <li>✓ If there is chest tightness, then give inhaled medicine (puffer), if ordered</li> </ul>
The trach tube has fallen out and the patient is having trouble breathing	<ul style="list-style-type: none"> <li>✓ Attempt to re-insert trach tube <b>ONCE</b> (see above)</li> <li>✓ <b>CALL 911</b></li> <li>✓ <b>If you cannot reinsert a trach tube of same size: try inserting either a tube that is one size smaller or a cuffless tube</b></li> <li>✓ Put a mask on the manual resuscitator bag</li> <li>✓ If the <b>patient needs oxygen</b>: remove oxygen supply from ventilator and connect to the manual resuscitation bag</li> <li>✓ Place the mask over the patient’s mouth and nose and give manual breaths. Have a second person cover the stoma while you manually ventilate</li> </ul>

---

**IMPORTANT! Always use a manual resuscitation bag to give breaths while you are troubleshooting.**

---



## Problems and Solutions – The Ventilator

---

**IMPORTANT! When a ventilator alarms, always look at the patient first, not the ventilator. Look to make sure that the chest is moving up and down. Make eye contact with the patient and ask “Are you okay?”**

---

Ventilators will alert you to a safety problem with a visual or an audible alarm. Some situations will trigger a visual or an audible alarm. Serious situations will trigger both audible and visual alarms together. You need to learn what the alarms mean on your ventilator.

Whatever the warning signal is, follow these steps:

1. Never leave the patient alone until the problem has been fixed
2. Use a manual resuscitation bag to ventilate the patient while you are trying to fix a ventilator problem
3. Find out which alarm went off
4. Correct any problems, if you find any
5. Replace any broken equipment
6. Change the ventilator circuit, if needed. You should always have a spare ventilator circuit set up, ready for use
7. Any equipment that failed is called ‘defective’. Do not use defective equipment. If your ventilator is defective, manually ventilate the patient. If there is no other ventilator available then call for an ambulance to take the patient to the nearest hospital
8. Once the patient is stable and taken care of, call the VEP to report the problem. The telephone number for VEP is 1-800-633-8977. A respiratory therapist is on hand 24 hours a day to help with ventilator issues and problems. Follow the prompts on the message for service after business hours
9. For other replacement disposable supplies, contact the home care company

The following **table** lists specific problems and what you can do to solve them. Please see manufacturer’s instructions for a complete list of alarms for your ventilator.

Alarm	Possible cause	What to do
High Pressure	<ul style="list-style-type: none"> <li>✓ Mucous plugs or mucous</li> <li>✓ Coughing, swallowing or hiccupping</li> <li>✓ Bronchospasm</li> <li>✓ Changes in patient’s breathing pattern. Patient is not responding to medicine or suctioning</li> <li>✓ Alarm set incorrectly</li> </ul>	<ul style="list-style-type: none"> <li>✓ Suction to remove mucous</li> <li>✓ If coughing, may need puffer or suctioning</li> <li>✓ Give inhaled medicine, if ordered</li> <li>✓ Contact the appropriate healthcare provider</li> <li>✓ Change alarm to proper setting</li> </ul>
Low Pressure/ Apnea	<ul style="list-style-type: none"> <li>✓ Leaks in the ventilator circuit</li> <li>✓ Water in pressure line</li> <li>✓ Patient is disconnected from ventilator</li> <li>✓ Leaks around trach or trach tube cuff</li> <li>✓ Alarm set incorrectly</li> <li>✓ Dirty inlet filter</li> </ul>	<ul style="list-style-type: none"> <li>✓ Look and feel for any leaks: exhalation valve, humidifier, pressure line, and tubing for leaks</li> <li>✓ Drain water</li> <li>✓ Reconnect patient to ventilator</li> <li>✓ Reposition patient and, or the trach tube. Try to deflate/ reinflate the cuff</li> <li>✓ Reset alarm to proper setting</li> <li>✓ Replace filter</li> </ul>
Setting	<ul style="list-style-type: none"> <li>✓ Settings are incorrect</li> <li>✓ Ventilator malfunction</li> </ul>	<ul style="list-style-type: none"> <li>✓ Reset settings</li> <li>✓ Manually ventilate patient and call the equipment provider</li> </ul>
Power Switch Over	<ul style="list-style-type: none"> <li>✓ Power source has changed from AC to internal or external power source</li> <li>✓ Power source has changed from external to internal</li> </ul>	<ul style="list-style-type: none"> <li>✓ Ensure ventilator is plugged in and there is power</li> <li>✓ If switching to or from an external battery, then press the <b>reset button to cancel the audible and visual alarm</b></li> </ul>
Low Power	<ul style="list-style-type: none"> <li>✓ Internal battery is discharged</li> </ul>	<ul style="list-style-type: none"> <li>✓ Plug in and operate ventilator on AC power for at least three hours. If no power is available then manually ventilate</li> </ul>



# Emergency Contacts & Planning

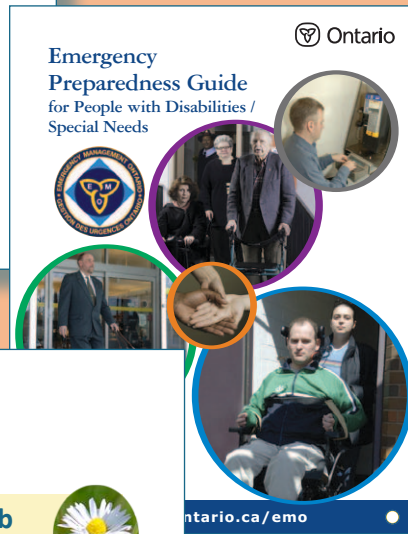
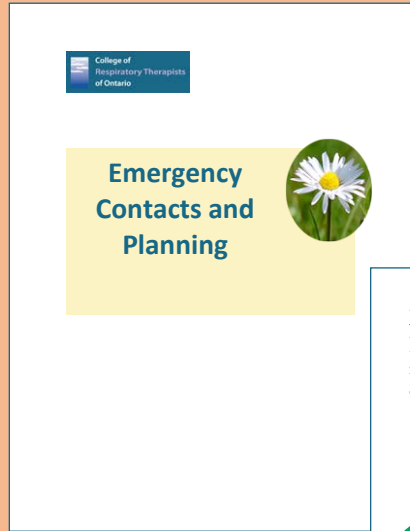





College of  
Respiratory Therapists  
of Ontario

# Emergency Contacts and Planning





# All About You

---

## Your Contact Information

First Name: \_\_\_\_\_

Middle Name: \_\_\_\_\_

Last (Family) Name: \_\_\_\_\_

Street Address: \_\_\_\_\_

City: \_\_\_\_\_ Postal Code: \_\_\_\_\_

Home Phone: \_\_\_\_\_ Cell Phone: \_\_\_\_\_

Fax: \_\_\_\_\_ Email: \_\_\_\_\_

Date of Birth: \_\_\_\_\_

Allergies: \_\_\_\_\_

## Your Ventilator Settings

These settings have been determined by your doctor and healthcare professionals team. Do not change the settings without first talking with your doctor and healthcare professionals.

Make: \_\_\_\_\_ Model: \_\_\_\_\_

Mode: \_\_\_\_\_

Volume: \_\_\_\_\_ Breath Rate: \_\_\_\_\_

Low Minute Volume: \_\_\_\_\_ Pressure: \_\_\_\_\_

---

**IMPORTANT! You need to have a complete list of your ventilator settings, even those settings that do not appear on the front panel of the ventilator.**

---



**If you use a speaking valve,** first deflate the cuff. Then change the ventilator settings to:

Volume: \_\_\_\_\_ Breath Rate: \_\_\_\_\_

Inspiratory Time (I:E ratio): \_\_\_\_\_

Breath Effort (sensitivity): \_\_\_\_\_

Low Alarm: \_\_\_\_\_ High Alarm: \_\_\_\_\_

## Keep track of ventilator setting changes

Ventilator Setting Change	Reason for Change	Date Changed

## Your Trach Tube

Make: \_\_\_\_\_ Model: \_\_\_\_\_

Type/Serial #: \_\_\_\_\_ Size: \_\_\_\_\_

Ordering information: \_\_\_\_\_

## Keep track of when the trach tube was changed

Date of Change	Tube Make/Model	Tube Size	Tube Type	Location	Who changed it?

## Keep track of medicine taken

Drug Name	What it does	How much or how many	When to take

## Special Instructions

---

---

---

---

---

---

---

---

## Your Personal Support Network

---

Your personal support networks are people who know about your healthcare needs and can be called upon to help you in an emergency.

### Family Doctor

Name: \_\_\_\_\_

Phone: \_\_\_\_\_

**Other Doctor Specialty:** \_\_\_\_\_

Name: \_\_\_\_\_

Phone: \_\_\_\_\_

**Home Healthcare Professional Specialty:** \_\_\_\_\_

Name: \_\_\_\_\_

Phone: \_\_\_\_\_

**Home Healthcare Professional Specialty:** \_\_\_\_\_

Name: \_\_\_\_\_

Phone: \_\_\_\_\_

### Equipment Supplier

Name: \_\_\_\_\_

Phone: \_\_\_\_\_

**Family Friend**

Name: \_\_\_\_\_

Phone: \_\_\_\_\_

**Family Friend**

Name: \_\_\_\_\_

Phone: \_\_\_\_\_

**Other Contact Specialty: Ventilator Equipment Pool**

Name: \_\_\_\_\_

Phone: \_\_\_\_\_

**Other Contact Specialty: Home Care Company**

Name: \_\_\_\_\_

Phone: \_\_\_\_\_

# Your Personal Emergency Plan

---

Developing a personal plan can help you to cope during an emergency. Completing the information below will help you to develop a good plan.

## What to do if there is a power failure?

Use your external D/C battery, given to you by the Ventilator Equipment Pool (VEP), for emergency use. A full charged battery should last 5-12 hours.

- ✓ Go somewhere where there is power. Somewhere close to your home. This could be a hospital, a hotel, a fire or ambulance hall. These places usually have power even during a power outage
- ✓ Call family or friends to see if their power is out. If they still have power, you could go there. Make sure there is at least one person on your contact list that lives close by and understands your needs
- ✓ Plan on how you might escape from your home. Getting out of your home quickly and safely can be difficult, so you need a plan. For example, if you live in a high rise apartment, it may not have adequate back up power for a long power outage. It may not be easy to get out of the building when the elevators are not working. So you need to have a plan

You need two external D/C batteries, if you want to be mobile with your ventilator. One battery to use when you are mobile, and the other battery in case of a power failure. The backup battery from the VEP is not to be used with your wheelchair. You need to buy another D/C external battery if you want to use your ventilator while you are mobile.

If you are having trouble paying for a second battery, consider going to Assistance for Children with Sever Disabilities (ACSD) or Ontario Disability Support Program (ODSP), insurance, or various service clubs to ask for help. Sometimes they can help with funding.

Consider where you could go if there was a prolonged power outage: List friends, family, hospital or fire station address here.

Family/Friend: \_\_\_\_\_

Street Address: \_\_\_\_\_

City: \_\_\_\_\_ Postal Code: \_\_\_\_\_

Contact Person: \_\_\_\_\_ Home Phone: \_\_\_\_\_

Cell Phone: \_\_\_\_\_

Out-of-Town Family/Friend: \_\_\_\_\_

Street Address: \_\_\_\_\_

City: \_\_\_\_\_ Postal Code: \_\_\_\_\_

Contact Person: \_\_\_\_\_ Home Phone: \_\_\_\_\_

Cell Phone: \_\_\_\_\_

## Long-term Emergency Refuge

---

If the power outage is long term you will have to leave your home and stay somewhere else for a while. Make plans on where you will go if this happens.

Street Address: \_\_\_\_\_

City: \_\_\_\_\_ Postal Code: \_\_\_\_\_

Contact Person: \_\_\_\_\_ Home Phone: \_\_\_\_\_

Cell Phone: \_\_\_\_\_

### How will I get there?

Have a transportation plan ready in case you need to leave home quickly.

Contact Person: \_\_\_\_\_ Home Phone: \_\_\_\_\_

Cell Phone: \_\_\_\_\_

### Travel Bag Checklist

In an emergency you will have to leave your home quickly. Have a travel bag packed with everything you would need to take with you in an emergency. The contents of your travel bag should include:

- Spare trach tubes: current trach tube size and another one that is one size smaller
- Ventilator settings
- Spare ventilator circuit and HMEs
- Your Contact List
  - Healthcare team names and phone numbers
  - Personal support network names and phone numbers
  - VEP phone number
  - Equipment supplier name and phone number
  - Oxygen supplier name and phone number
- List of medicines and inhalers (puffers)
- Resuscitation bag and mask
- Portable suction unit and supplies
- D/C Battery



## Fire Precautions

---

### Fire Extinguishers

- ✓ Have two fire extinguishers in the home
- ✓ Your fire extinguishers need to be checked once a year

### Smoke Detectors

- ✓ Have one smoke detector on every level in your home
- ✓ Change the batteries in your smoke detectors twice a year. Many people change their smoke alarm batteries twice a year; when they change their clocks in the spring and the fall. Write the date you changed the batteries, on the smoke detector
- ✓ Post a “No Smoking/Flame” sign, if oxygen is in use

### Emergency Supplies

An emergency situation may occur that requires you to stay in your home for a long period of time. So it is wise to have some emergency supplies. Have enough supplies for a week.

According to the “Emergency Preparedness Guide for People with Disabilities/Special Needs” from Emergency Management Ontario. Here is what they suggest:

- Respiratory travel bag
- Enough medications
- MedicAlert® bracelet or identification
- Bottled water
- Food (non-perishable)
- Manual can opener
- Flashlight(s) & batteries
- Battery operated radio & batteries or crank radio
- Spare batteries
- Candles and matches/lighter
- Important papers (identification)
- Clothing and footwear
- Blankets or sleeping bags
- Toilet paper and other personal items
- Telephone that can work during a power disruption
- Extra car keys and cash

- Whistle (to attract attention, if needed)
- Playing cards
- First-aid kit
- Backpack or duffle bag

This Guide may found at the web site [www.emergencymanagementontario.ca](http://www.emergencymanagementontario.ca). Make sure that your supplies do not become too old to use. For example, keep your medicine up to date. Buy bottled water and food with a long expiry date. You should also check your flashlight(s) and replace the batteries from time to time.





College of  
Respiratory Therapists  
of Ontario

# Emergency Preparedness Guide



Acknowledgement of  
Source

The following document, titled “**Emergency Preparedness Guide for People with Disabilities/Special Needs**” has been provided by **Emergency Management Ontario**.

The following acknowledges the original copyright claimed by the **Queen’s Printer of Ontario**:

© **Queen’s Printer for Ontario, 2007. Reproduced with permission.**

The document is being reproduced here with permission from **Emergency Management Ontario** in the form originally made available.

# Emergency Preparedness Guide

for People with Disabilities /  
Special Needs



# Acknowledgements ● ● ● ● ●

This Emergency Preparedness Guide for People with Disabilities and/or Special Needs was prepared by the Government of Ontario's Emergency Management Ontario in partnership with the Accessibility Directorate of Ontario.

In order to produce a guide that promotes the values and protects the integrity, independence and safety of all Ontarians, the following organizations were consulted for their subject matter expertise and special insights, for which we are most appreciative:

- Canadian Diabetes Association
- Canadian MedicAlert® Foundation
- Canadian Paraplegic Association (Ontario)
- Canadian Red Cross
- Centre for Independent Living in Toronto (CILT) Inc.
- CNIB
- Foreign Affairs and International Trade Canada
- Learning Disabilities Association of Ontario
- Ministry of Community and Social Services Emergency Management Unit
- Ministry of Government Services
- Multiple Sclerosis Society of Canada, Toronto Chapter and Ontario Division
- National (USA) Organization on Disability - Headquarters
- Office of the Fire Marshal – Ontario Head Office
- Ontario March of Dimes (Provincial Office)
- Ontario Seniors' Secretariat
- Ontario SPCA (Ontario Society for the Prevention of Cruelty to Animals)
- SOS Emergency Response Technologies
- St. Demetrius Development Corporation
- The Canadian Hearing Society
- Toronto Rehabilitation Institute

Special appreciation is also extended to all the people that volunteered their time to pose for the pictures throughout this guide.

## **Emergency Management Ontario**

Ministry of Community Safety  
and Correctional Services  
[www.ontario.ca/emo](http://www.ontario.ca/emo)

## **Accessibility Directorate of Ontario**

Ministry of Community  
and Social Services  
[www.mcass.gov.on.ca](http://www.mcass.gov.on.ca)

---

Since not every emergency situation is similar or predictable, every person should rely on and use their best judgement when offering assistance to others in an emergency, without putting their own or other people's safety at risk.

© Queen's Printer for Ontario 2007

All material created in this guide is protected by Crown Copyright, which is held by the Queen's Printer for Ontario. No materials can be reproduced or copied in part or in whole without the expressed written permission of the Ministry of Community Safety and Correctional Services.

• • • • • Contents

Introduction . . . . . 2

Emergency Survival Kit Checklist . . . . . 3

Service Animal Emergency Kit Checklist . . . . . 4

Important Considerations . . . . . 5

Categories

 **Mobility** . . . . . 8

 **Vision** . . . . . 10

 **Hearing** . . . . . 12

 **Non-Visible Disabilities** . . . . . 14

 **Seniors with Special Needs** . . . . . 16

 **Highrise Safety** . . . . . 18

 **Travel Considerations** . . . . . 20

For More Information . . . . . 22

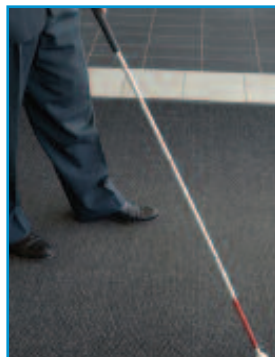



# Introduction ● ● ● ● ●



Emergencies can occur suddenly and without any advance warning. Although Ontario has effective emergency management legislation and programs, individuals and families play a vital role in preparing for times of crisis when emergency services and other government resources may be strained. It is important that individuals and families prepare to be self-reliant for at least three (3) days

immediately after or during an emergency. This guide provides special emergency preparedness considerations and advice for the estimated 1.5 million Ontarians with disabilities and/or special needs, including seniors with special needs.

## Prepare Now

Emergency preparedness includes developing and practising a family emergency response plan and the preparation of an emergency survival kit.

For those living with a physical, visual, auditory and/or other non-visible disability, emergency preparedness should also involve incorporating special accommodations into their family emergency response plan. To best prepare for an emergency according to one's special needs, please refer to the appropriate category in this guide for a list of suggested emergency survival kit items and contingency planning considerations.

For more information on emergency management arrangements in your area contact your municipal Emergency Management Coordinator through your local government office.

## Using this Guide

This guide covers topics relevant to the emergency preparedness needs of people with visible and/or non-visible disabilities and seniors with special needs.

- Disabilities/special needs are identified as separate categories according to colour and a symbol shown on the top right hand corner of each page.
- Each category provides information on how individuals should prepare for an emergency given their special needs, how the public can best assist a person with a disability and additional suggested survival kit items.
- The last page is an additional contact information resource for the reader.
- Copies of this guide are available in both English and French, and in alternative formats upon request. Please contact:

### Emergency Management Ontario

General Tel: 416-314-3723

Toll-free Phone: 1-877-314-3723

### Accessibility Directorate of Ontario

General Tel: 416-326-0207

Toll-free Phone: 1-888-520-5828

TTY: 416-326-0148

Toll-free TTY: 1-888-335-6611

# ••••• Emergency Survival Kit Checklist

This Emergency Survival Kit checklist outlines the basic items every individual should keep in an easy-to-reach place to help them be self-reliant for at least three (3) days immediately after or during an emergency. Since emergency supply requirements vary for individuals with different disabilities, please refer to the appropriate category in this guide for additional suggested survival kit items.

## Prepare Now, Emergency Survival Checklist Learn How...

- Flashlight and batteries
- Radio and batteries or crank radio
- Spare batteries (for radio, flashlight, assistive devices, etc.)
- First-aid kit
- Telephone that can work during a power disruption
- Candles and matches/lighter
- Extra car keys and cash
- Important papers (identification)
- Non-perishable food and bottled water
- Manual can opener
- Clothing and footwear
- Blankets or sleeping bags
- Toilet paper and other personal items
- Medication
- MedicAlert® bracelet or identification
- Backpack/duffle bag
- Whistle (to attract attention, if needed)
- Playing cards



# Service Animal Emergency Kit Checklist



This Service Animal Emergency Kit checklist outlines the basic items every person with a service animal should have prepared in advance to keep their service animals comfortable during the stress of an emergency situation. It is advisable to keep all items in a transportable bag that is easy to access should evacuating the home become necessary. Also, remember to check the kit twice a year (an easy way to remember is to do it when you check your smoke alarms bi-annually) to ensure freshness of food, water and medication, and to restock any supplies you may have “borrowed” from the kit.

## Service Animal Emergency Kit Checklist









- Minimum 3-day supply of bottled water and pet food
- Portable water and food bowls
- Paper towels and can opener
- Medications with a list identifying reason (e.g., medical condition), dosage, frequency and contact information of prescribing veterinarian
- Medical records including vaccinations
- Leash/harness
- Muzzle (if required)
- Blanket and favourite toy
- Plastic bags
- Up-to-date ID tag with your phone number and the name/phone number of your veterinarian (microchipping is also recommended)
- Current photo of your service animal in case they get lost or separated from you
- Copy of licence (if required)

### Pet Owners:

While service animals are accepted at shelters in an emergency, family pets are not. Hence, it is advisable for pet owners to prepare a similar emergency kit for each family pet according to the needs of each different animal (e.g., cat, rabbit, bird, etc.). In the case of cats, include a cat carrier, little pan, litter, scooper and plastic bags. It is also recommended for pet owners to have prior arrangements made with family or friends to take care of their animal, should evacuating the home be necessary during an emergency. For additional information on pets and emergencies, please visit the Emergency Management Ontario website at [www.ontario.ca/emo](http://www.ontario.ca/emo).













# ••••• Important Considerations

## Remember...

-  The emergency survival kit items listed in this guide are only a suggestion and may or may not apply to every emergency situation and/or a person's special needs. Therefore you should decide which essential items to include for yourself and your family members.
-  During an emergency you may have no electrical power.
-  During an emergency you may need to go to an emergency evacuation shelter. It is recommended that you and your family have a designated contact person that resides outside of your immediate community. This way, in the event of an evacuation, family members can easily notify each other by calling their designated contact person.
-  Pack and store all emergency survival items (including medications, medical supplies and/or assistive devices) in an easy-to-access and easy-to-transport container should you need to evacuate.
-  Select a network of individuals at work and at home that will be able to assist you during an emergency. (Make sure you inform your network of where you keep your emergency survival kit.)
-  Prepare a list of any food or drug allergies you might have and all the medications you are taking. You may want to provide this list to your designated network and also keep a copy in your emergency survival kit, on your person, at home, your workplace and in your car (if applicable).
-  On your list of medications, specify the reason for each medicine that you are taking (e.g., medical condition being treated) including the generic name, dosage, frequency, and the name and contact information of the prescribing physician.
-  If you have children with a disability or special needs, prepare a similar list for each of your children and provide it to their caregiver, school, emergency contact members, etc.
-  If you have an allergy, chronic medical condition, or special medical need you may want to consider owning and wearing a MedicAlert® bracelet or identification as part of your emergency preparedness plan.  
For more information visit: [www.medicalert.ca](http://www.medicalert.ca).

# Important Considerations ● ● ● ● ●

## Remember...

-  Regularly check expiration dates on all medications, bottled water, and canned/package food in your emergency survival kit. It is best to replace food and bottled water at least once a year.
-  Prepare a contact information list of all your emergency contact persons and provide a copy to your designated network at work and/or home. Also keep a copy in your survival kit, on your person, at home, at your workplace and in your car (if applicable).
-  Provide written instructions for your network on how best to assist you and your service animal (if applicable) during an emergency.
-  Label all of your special needs equipment and attach laminated instruction cards on how to use, retrieve and/or move each assistive device during an emergency.
-  Since your medications, assistive devices, etc. may change over time, it is advisable for you to regularly assess your needs and incorporate any changes to your emergency survival kit supplies and your family emergency plan.
-  If your personal needs require regular attendant care and/or life sustaining apparatus, arrange with your network to check on you immediately if an emergency occurs or if local officials issue an evacuation order.
-  Carry a personal alarm that emits a loud noise to draw attention to your whereabouts.
-  If you rely on any life sustaining equipment/apparatus, develop an emergency back-up plan that will ensure the equipment/apparatus works in the event of a power outage.
-  Install working smoke alarms on every floor of your home and outside all sleeping areas.
-  Test smoke alarms on a monthly basis by pushing the test button. Replace smoke alarm batteries every six months and whenever the low-battery warning sounds.
-  Develop and practise a home fire escape plan or refer to your building's fire safety plan so that everyone in your home knows what to do in the event of a fire.
-  Practise your emergency plan with your network at least twice a year.
-  If during an emergency your support network cannot assist you for whatever reason, ask other individuals around you to help you. Remember to inform them of your special needs and how they can best offer any assistance to you.



# ••••• Important Considerations

## Tips on Helping a Person with a Disability

- ☞ "Ask First" if the person needs or wants your help – do not just assume that they do.
- ☞ Allow the person to identify how best to assist them.
- ☞ Do not touch the person, their service animal and/or their assistive device/equipment without their permission.
- ☞ Follow instructions posted on special needs equipment and/or assistive device during an emergency.
- ☞ Avoid attempts to lift, support or assist in moving someone unless you are familiar with safe techniques.
- ☞ Never administer any food or liquids to an unconscious or unresponsive person.
- ☞ Be aware that some people who have disabilities may request that you use latex-free gloves to reduce spread of viral infection to them.
- ☞ Ask the person with special needs if areas of their body have reduced sensation and if they need you to check those areas for injuries after a disaster.



# Mobility ● ● ● ● ●



Mobility limitations may make it difficult for a person to use stairs or to move quickly over long distances. These can include reliance on mobility devices such as a wheelchair, scooter, walker, crutches or a walking cane. In addition, people with a heart condition or various respiratory difficulties can experience certain levels of mobility limitations.

## Your Emergency Plan:

- Ask your network to practise moving your special needs equipment during your emergency practice plan.

This will help your network become more comfortable handling or using your special needs equipment during an emergency.

- If you use a wheelchair or scooter, request that an emergency evacuation chair be stored near a stairwell on the same floor that you work or live on, so that your network can readily use it to help you safely evacuate the building.
- In your instruction list for your network, identify areas of your body that have reduced sensation so these areas can be checked for injuries after an emergency, if you cannot check them yourself.
- Check with your local municipal office to find out if emergency evacuation shelters in your area are wheelchair accessible.

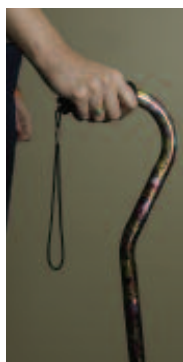



## Additional Items Emergency Survival Kit

### Dos & Don'ts

#### Assisting People with Disabilities

- ✓ Use latex-free gloves when providing personal care whenever possible. (People with spinal cord injury have a greater risk of developing an infectious disease during an emergency. Gloves help control secondary medical conditions that can easily arise if personal care is disrupted during an emergency.)
- ✓ Ensure that the person's wheelchair goes with the person.
- ✗ Do not push or pull a person's wheelchair without their permission.

- Tire patch kit.
- Can of seal-in-air product (to repair flat tires on your wheelchair or scooter).
- Supply of inner tubes.
- Pair of heavy gloves (to protect your hands while wheeling or making way over glass or other sharp debris).
- Latex-free gloves (for anyone providing personal care to you).
- Spare deep-cycle battery for motorized wheelchair or scooter.
- A lightweight manual wheelchair for backup to a motorized wheelchair (if feasible).
- Spare catheters (if applicable).
- An emergency back-up plan that will ensure any life sustaining equipment/apparatus is operable in the event of a power outage.
- Any other contingency supplies unique to your special needs.





# Vision ● ● ● ● ●



## Your Emergency Plan:

- Have a long cane available to readily manoeuvre around debris on the floor or furniture that may have shifted after an emergency.
- Mark all emergency supplies in advance with fluorescent tape, large print or in braille.
- Mark gas, water and electric shutoff valves in advance with fluorescent tape, large print or in braille.
- Familiarize yourself in advance with all escape routes and locations of emergency doors/exits on each floor of any building where you work, live and/or visit.

Vision loss can include a broad range of conditions ranging from complete blindness to partial or low vision that cannot be corrected with lenses or surgery. A person's ability to read signs or move through unfamiliar environments during an emergency may be challenged, creating a feeling of being lost and/or being dependent on others for guidance.

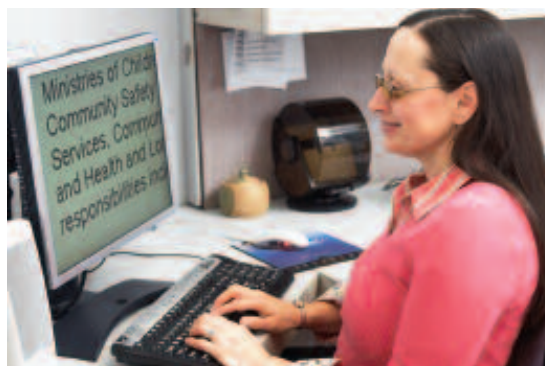



## Additional Items Emergency Survival Kit

### Dos & Don'ts

#### Assisting People with Disabilities

- ✓ Always ask first if you can be of any assistance to them.
- ✓ For people who are deaf-blind, use your finger to draw an "X" on their back to let them know you are there to help during an emergency.
- ✓ To communicate with a deaf-blind person, try tracing letters with your finger on the palm of their hand.
- ✓ To guide the person, offer them your arm instead of taking theirs and walk at their pace. Keep half a step ahead of them.
- ✓ If the person has a service dog, ask them where you should walk to avoid distracting the animal.
- ✓ Provide advance warning of upcoming stairs, curbs, major obstacles, or changes in direction.
- ✓ Watch for overhangs or protrusions the person could walk into.

- Extra white cane, preferably a cane that is longer in length.
- Talking or braille clock.
- Large-print timepiece with extra batteries.
- Extra vision aids such as an electronic travel aid, monocular, binocular or magnifier.
- Extra pair of prescription glasses – if you wear them.
- Any reading devices/assistive technology to access information/portable CCTV devices.
- Any other contingency supplies unique to your special needs.

- ✗ Do not assume the person cannot see you, or that they need your help.
- ✗ Never grab or touch a person with vision loss.
- ✗ Do not touch, make eye contact or distract the person's service dog as this can seriously endanger the owner.
- ✗ Do not shout at a person with vision loss. Speak clearly and provide specific and precise directions.
- ✗ Avoid the term "over there". Instead, describe locating positions such as, "to your right/left/straight ahead/behind you", or by relaying clock face positions. (For example: 12 o'clock)

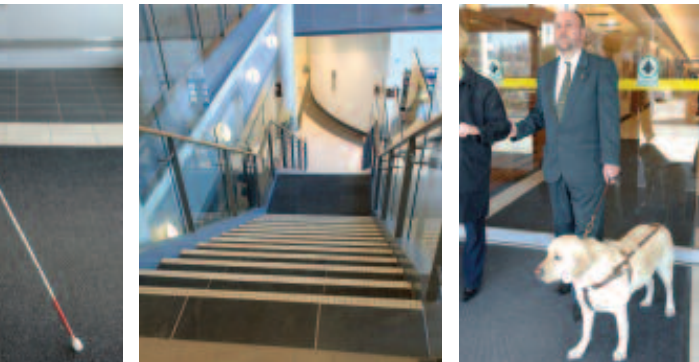

# Hearing ● ● ● ● ●

A person can be deaf, deafened or hard of hearing. The distinction between these terms is based on the individual's language and means of communicating rather than the degree of hearing loss.

In an emergency, the method in which emergency warnings are issued becomes critical to how a person with hearing loss is able to respond and follow instructions to safety.

## Your Emergency Plan:

- If your network is unavailable during an emergency, seek the assistance of others to whom you can communicate your hearing loss by spoken language, moving your lips without making a sound, pointing to your ear, using a gesture, or if applicable, pointing to your hearing aid.
- Keep a pencil and paper handy for written communication.
- Obtain a pager that is connected to an emergency paging system at your workplace and/or the building that you live in.
- Install a smoke-detection system that includes smoke alarms and accessory flashing strobe lights or vibrators to gain your attention if the alarms sound.
- Test smoke alarms on a monthly basis by pushing the test button.
- Replace batteries in battery-operated smoke alarms every six months and whenever the low-battery warning sounds.
- Keep a laminated card on your person and in your survival kit that identifies you as deaf or hard of hearing and explains how to communicate with you.

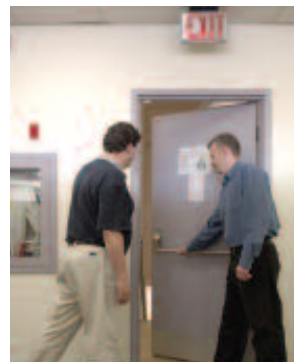
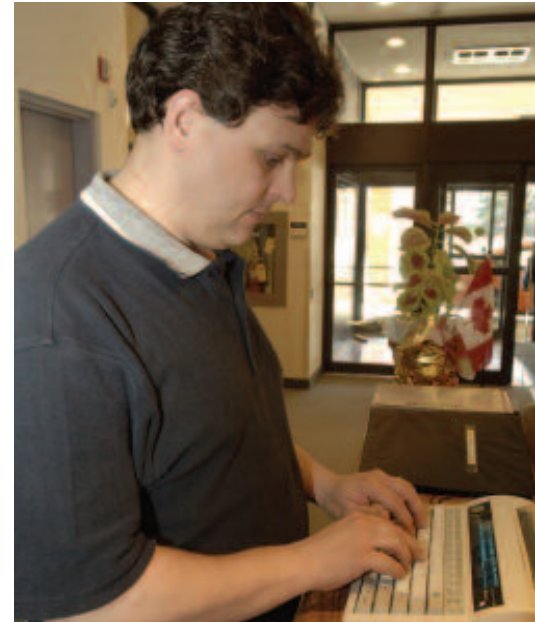





## Additional Items Emergency Survival Kit

### Dos & Don'ts

#### Assisting People with Disabilities

- ✓ Get the person's attention via a visual cue or a gentle touch on their arm before speaking to them.
- ✓ Face the person and make eye contact when speaking to them as they may rely on speechreading.
- ✓ Communicate in close proximity.
- ✓ Speak clearly and naturally.
- ✓ Use gestures to help explain the meaning of what you are trying to communicate to the person.
- ✓ Write a message if there is time and keep a pencil and paper handy.
- ✗ Avoid approaching the person from behind.
- ✗ Refrain from shouting or speaking unnaturally slowly.
- ✗ Do not make loud noises as hearing aids amplify sounds and can create a physical shock to the user.

- Extra writing pads and pencils for communication.
- Flashlight, whistle or noisemaker.
- Pre-printed key phrases you would use during an emergency.
- Assistive devices - unique to your needs (e.g., hearing aid, pager, personal amplifier, etc.).
- Portable visual notification devices that allow you to know if a person is knocking on the door, ringing the doorbell, or calling on the telephone.
- Extra batteries for assistive devices.
- A CommuniCard (produced by The Canadian Hearing Society) that explains your hearing loss and also helps identify how rescuers or assisters can communicate with you during an emergency.
- Any other contingency supplies unique to your special needs.



**Note:** Typically people who are deafened or hard of hearing will need information presented in a text format.

# Non-Visible Disabilities ● ● ● ● ●



Non-visible disabilities can include communication, cognitive, sensory, mental health, learning or intellectual disabilities in which an individual's ability to respond to an emergency is restricted. They can also range from allergies, epilepsy, hemophilia, diabetes, thyroid condition, multiple sclerosis, pulmonary or heart disease and/or dependency on dialysis, sanitary or urinary supplies. Individuals with non-visible disabilities may have difficulty performing some tasks without appearing to have a disability.

## Your Emergency Plan:

- Prepare an easy-to-understand list of instructions or information for yourself that you think you may need in an emergency.
- Keep an emergency contact list on your person of key people that are aware of your special needs.
- Inform your designated support network of where you store your medication.
- Keep a pencil and paper or portable electronic recording device handy to write down or record any new instructions provided to you in an emergency.
- Consider owning and wearing a MedicAlert® bracelet or identification because it will help notify emergency responders about your non-visible disabilities. For more information visit: [www.medicalert.ca](http://www.medicalert.ca).
- Request a panic push-button to be installed in the building you work and/or live in, so that in the event of an emergency you can notify others of your whereabouts and that you need special assistance.
- **People with Multiple Sclerosis:** Symptoms are often made worse by heat and humidity. Be prepared to keep cool and dry.
- **People with Diabetes:** Keep frozen water bottles or ice packs in your freezer. Have an insulated bag or cooled thermos ready to store your insulin, should there be a power outage or you need to evacuate.



## Dos & Don'ts

### Assisting People with Disabilities

- ✓ Allow the person to describe what help they need from you.
- ✓ Find effective means of communication (e.g., provide drawn or written instructions. When giving directions use landmarks instead of terms "go left" or "turn right").
- ✓ Be patient, flexible and maintain eye contact when speaking to the person.
- ✓ Repeat instructions (if needed).
- ✓ Ask the person about their medication and if they need any help taking it. (Never offer medicines not prescribed by their physician.)
- ✓ Keep people with multiple sclerosis cool and dry to avoid making their symptoms worse.
- ✗ Avoid shouting or speaking quickly. Instead, speak clearly but not so slowly as to offend the person.
- ✗ Do not restrain a person having a convulsion. Instead, roll them on their side to keep their airway clear and place something soft (e.g., your jacket) under their head to protect it from injury. Once the convulsion passes and they become conscious, help them into a resting position.

## Additional Items Emergency Survival Kit

- Supply of food items appropriate to your disability or dietary restrictions.
- List of instructions that you can easily follow in an emergency.
- Personal list and minimum three days supply of all needed medications, medical supplies and special equipment (e.g., ventilator for asthma, nitrolingual spray for heart condition, Epinephrine pen against allergic reaction/anaphylactic shock, etc.).
- Detailed list of all prescription medications.
- MedicAlert® identification.
- Any other contingency supplies unique to your special needs.

### For Example: People with Diabetes

- Extra supply of insulin or oral agent.
- Extra supply of syringes, needles and insulin pens (if used).
- Small container for storing used syringes/needles (if applicable).
- Blood glucose testing kit, spare batteries and record book.
- Supply of blood glucose and urine ketone testing strips.
- Fast-acting insulin for high blood glucose (if applicable).
- Fast-acting sugar for low blood glucose.
- Extra food to cover delayed meals.
- Ice packs and thermal bag to store insulin (if applicable).

# Seniors with Special Needs ● ● ● ● ●



Since an emergency situation or an evacuation can be a frightening and confusing time, it is important that seniors, especially those with special needs, know the steps to take in an emergency. This includes seniors contacting their local municipal office to find out about programs and services available in their community that will help them during an emergency and assist them to return to their regular routine.

## Your Emergency Plan:

- Create an emergency contact list with names and telephone numbers of your physicians, case worker, contact for your seniors group, neighbours, building superintendent, etc. Keep a copy of this list in your survival kit and on your person.
- Write down the names and phone numbers of on-site doctors, nurses,

social workers, etc., at your place of residence (if applicable), including the hours they keep.

- Familiarize yourself with all escape routes and location of emergency doors/exits in your home.
- Know the location of emergency buttons. (Many seniors' buildings have emergency buttons located in bedrooms and washrooms that have a direct link to 911 or the building's superintendent.)
- If asked to evacuate, bring with you any equipment or assistive devices you may need immediately.
- Always wear your MedicAlert® identification.





## Dos & Don'ts

### Assisting People with Disabilities

- ✓ Check on neighbours who are seniors with special needs to find out if they need your help during an emergency or evacuation.
- ✓ Allow the person to describe what help they need and how it can be provided to them.
- ✓ Be patient, listen actively.
- ✓ If the person appears anxious or agitated, speak calmly and provide assurance that you are there to help.
- ✓ If evacuation is necessary, offer a ride to seniors who do not have access to a vehicle.
- ✓ If time permits, offer to carry the person's emergency survival kit to your car, along with any equipment or assistive devices they will need.
- ✓ Follow instructions posted on special needs equipment and/or assistive devices during an emergency.



## Additional Items Emergency Survival Kit

- Supply of food items appropriate to your disability or dietary restrictions.
- Assistive devices needed such as canes, walkers, lightweight manual wheelchair, hearing aids, breathing apparatus, blood glucose monitoring device, etc.
- Prescription eyewear and footwear (if required).
- Extra supply of medications and vitamin supplements.
- Personal disability-related list of all your needed medical supplies and special equipment.
- Copies of all medication prescriptions.
- Extra dentures (if required) and cleaner.
- Latex-free gloves (to give to anyone providing personal care to you).
- Any other contingency supplies unique to your special needs.

### For Seniors with Diabetes:

- Please refer to previous "Other Non-Visible Disabilities" category.

- ✗ Refrain from shouting or speaking unnaturally slowly.
- ✗ Avoid being dismissive of the person's concerns or requests.



# Highrise Safety ● ● ● ● ●

High-rise buildings present unique challenges when evacuation is necessary during an emergency.

## Residents should make themselves aware of:

- ✓ Building superintendent's name and phone number.
- ✓ Who sits on the Building Safety Committee.
- ✓ Who the floor monitors are.
- ✓ Who conducts evacuation drills, and how often.
- ✓ Location of fire extinguishers, automated external defibrillator units, and oxygen tank.
- ✓ Location of emergency evacuation device(s).

## Your Emergency Plan:

- Advise your building manager/superintendent of your special needs and/or requirements during an emergency.
- Familiarize yourself with your building's evacuation plan.
- Know where all escape routes and location of emergency doors/exits are on each floor.
- Know the location of emergency buttons in the building and exits that are wheelchair-accessible (if applicable).
- Request that an emergency evacuation chair be installed on the floor you live or work on, preferably close to the stairwell (if applicable).
- If you live in a highrise building, create a 'buddy' system with your neighbours and regularly practise your emergency response plan with them.
- If you rely on any life sustaining equipment/apparatus, develop an emergency back-up plan that will ensure the equipment/apparatus is operable in the event of a power outage.
- Obtain large printed signs from the building manager that you can place in your window in the event of an emergency, indicating that you need assistance.





## Dos & Don'ts

### Assisting People with Disabilities

- ✓ Check on neighbours and/or co-workers with special needs to find out if they need your help during an emergency or evacuation.
- ✓ Listen actively to what the individual with special needs is saying.
- ✓ During an emergency evacuation (if time permits), offer to carry the person's emergency survival kit for them along with any special equipment or assistive devices they will need.
- ✓ Review previous categories in this guide on how to assist people with specific disabilities and/or special needs.
- ✗ In general, avoid attempts to lift, support or assist in moving a person down the stairs, unless you are familiar with safe techniques.

## Additional Items Emergency Survival Kit

- Personal alarm that emits a loud noise to draw attention to your whereabouts.
- Supply of food items appropriate to your dietary restrictions.
- Supply of medications and assistive devices appropriate to your disability.
- Supply of plastic bags for storing garbage/personal waste.
- Names and contact information of your neighbours, superintendent and property/building manager.
- Laminated copy of your building's evacuation plan and diagram of escape routes and location of emergency doors/exits on each floor.
- Any other contingency supplies unique to your special needs.



# Travel Considerations ● ● ● ● ●



Whether travelling locally or internationally, people with disabilities and seniors with special needs should take extra time to research and plan their trip to make their travel experience safe and enjoyable. This includes preparing in advance, an emergency plan and “Ready-Go-Bag” with emergency survival items.

## Your Emergency Plan:

- Before travelling, visit the **Foreign Affairs and International Trade Canada** website at [www.voyage.gc.ca](http://www.voyage.gc.ca) where you can register and find other helpful travel information safety tips.
- Discuss your particular accommodation needs with your travel agent.
- Discuss your trip with your doctor to prepare contingency plans in case of illness.
- Obtain necessary travel medical insurance.
- Carry a copy of the

booklet **Bon Voyage, But...**, that contains contact information for your destination's Canadian office and Emergency Operations Centre. You can order it free of charge at [www.voyage.gc.ca](http://www.voyage.gc.ca).

- Divide your medications and medical supplies between your carry-on and check-in baggage, keeping them in their original labelled containers. Bring copies of your prescriptions with you.
- Always wear your MedicAlert® bracelet.

- Inform your travel companion(s) on how to assist you in an emergency.
- If travelling alone, establish a network (e.g., hotel staff) that can assist you during an emergency.
- If you have difficulty using stairs request a room on a lower floor.
- Review the hotel emergency exit plan.
- If needing to evacuate, bring your emergency “Ready-Go-Bag” and any assistive devices you may need.







## Dos & Don'ts

### Assisting People with Disabilities

- ✓ Check on fellow travellers with visible disabilities or special needs to find out if they need your help during an emergency or evacuation.
- ✓ Listen actively to what the individual with special needs is saying and how they might need your help.
- ✓ If they speak in a foreign language that you do not understand, try to communicate using gestures.
- ✓ During an emergency evacuation (if time permits), offer to carry the person's emergency survival kit for them along with any special equipment or assistive devices they will need.
- ✓ Review previous categories in this guide on how to assist people with specific disabilities or special needs.
- ✗ Do not let the person be separated from their wheelchair or mobility aids.

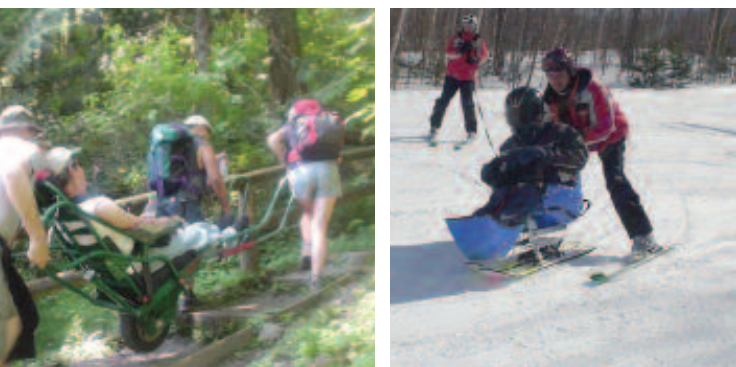

## Additional Items Emergency Survival Kit

- Supply of food items appropriate to your dietary restrictions.
- Supply of medications/assistive devices appropriate to your disability (e.g., **Glucagen injection** if you manage your diabetes with insulin and you are travelling to a remote location that does not have ambulance service).
- Laminated personal information card that you keep on your person at all times when travelling. (Card identifies your special needs, lists all medications you are taking, any food/drug allergies you might have, your treating physician's name and contact information, and your next of kin.)
- Copy of your travel medical insurance and other important travel documents.
- A personal alarm that emits a loud noise to draw attention to your whereabouts.
- Small container that can store or disintegrate syringes or needles safely (if applicable).
- Anti-nausea and anti-diarrhea pills and pain medication.
- Sunblock.
- Insect repellent.
- Dictionary to help you communicate in a foreign language.
- Any other contingency supplies unique to your disability or special needs.

# For More Information ●●●●●

## Specific Disabilities and Special Needs

### Canadian Diabetes Association

Tel: 416-363-3373  
Toll-free Phone: 1-800-226-8464  
Fax: 416-408-7117  
[www.diabetes.ca](http://www.diabetes.ca)

### Canadian Paraplegic Association Ontario

Tel: 416-422-5644  
Toll-free Phone: 1-877-422-1112  
Fax: 416-422-5943  
Email: [info@cpaont.org](mailto:info@cpaont.org)  
[www.cpaont.org](http://www.cpaont.org)

### Canadian Red Cross

Tel: 905-890-1000  
Fax: 905-890-1008  
[www.redcross.ca](http://www.redcross.ca)

### Centre for Independent Living in Toronto (CILT) Inc.

Tel: 416-599-2458  
TTY: 416-599-5077  
24hr Newsline: 416-599-4898  
Fax: 416-599-3555  
Email: [cilt@cilt.ca](mailto:cilt@cilt.ca)  
[www.cilt.ca](http://www.cilt.ca)

### CNIB

Tel: 416-486-2500  
Toll-free Phone: 1-800-563-2642  
TTY: 416-480-8645  
Fax: 416-480-7700  
[www.cnib.ca](http://www.cnib.ca)

### Learning Disabilities Association of Ontario

Tel: 416-929-4311  
Fax: 416-929-3905  
[www.ldao.ca](http://www.ldao.ca)

### Multiple Sclerosis Society of Canada - Toronto Chapter and Ontario Division

Tel: 416-922-6065  
Toll-free Phone: 1-866-922-6065  
Fax: 416-922-7538  
[www.mssociety.ca](http://www.mssociety.ca)

### Ontario March of Dimes

Tel: 416-425-3463  
Toll-free Phone: 1-800-263-3463  
Fax: 416-425-1920  
[www.dimes.on.ca](http://www.dimes.on.ca)

### Ontario SPCA (Ontario Society for the Prevention of Cruelty to Animals)

Tel: 905-898-7122  
Toll-free Phone: 1-888-ONT-SPCA (668-7722)  
Fax: 905-853-8643  
E-mail: [info@ospca.on.ca](mailto:info@ospca.on.ca)  
[www.ontariospca.ca](http://www.ontariospca.ca)

### The Canadian Hearing Society

Tel: 416-928-2500  
Toll-free Phone: 1-877-347-3427  
TTY: 416-964-0023  
Toll-free TTY: 1-877-347-3429  
Fax: 416-928-2523  
[www.chs.ca](http://www.chs.ca)

### Toronto Rehabilitation Institute

Tel: 416-597-3422  
Fax: 416-597-1977  
[www.torontorehab.com](http://www.torontorehab.com)

## Accessibility Initiatives

### Accessibility Directorate of Ontario

Tel: 416-326-0207  
Toll-free Phone: 1-888-520-5828  
TTY: 416-326-0148  
Toll-free TTY: 1-888-335-6611  
Fax: 416-326-9725  
[www.mcass.gov.on.ca](http://www.mcass.gov.on.ca)

### Ontario Seniors' Secretariat

Tel: 416-326-7076 (Seniors' INFOLine)  
Toll-free Phone: 1-888-910-1999  
Toll-free TTY: 1-800-387-5559  
Fax: 416-326-7078  
[www.ontarioseniors.ca](http://www.ontarioseniors.ca)

## Emergency Preparedness

### Emergency Management Ontario

Tel: 416-314-3723  
Toll-free Phone: 1-877-314-3723  
Fax: 416-314-3758  
[www.ontario.ca/emo](http://www.ontario.ca/emo)

## For Information on MedicAlert® Bracelets or Identification

### Canadian MedicAlert® Foundation

Tel: 416-696-0142  
Toll-free Phone: 1-800-668-1507  
Toll-free Fax: 1-800-392-8422  
[www.medicalert.ca](http://www.medicalert.ca)

## For Travel Advice and Registration Service when Travelling Abroad

### Foreign Affairs and International Trade Canada

Tel: 613-944-6788  
TTY: 613-944-1310  
**In Canada and USA:**  
Toll-free Phone: 1-800-267-6788  
Toll-free TTY: 1-800-394-3472  
[www.voyage.gc.ca](http://www.voyage.gc.ca)

**Local Emergency Management Contact:**

**This guide is courtesy of:**

© Queen's Printer for Ontario, 2007  
ISBN 978-1-4249-2380-9  
10M 01/07  
Disponible en français

© Imprimeur de la Reine pour l'Ontario 2007  
ISBN 978-1-4249-2386-1  
10M 01/07  
Available in English





College of  
Respiratory Therapists  
of Ontario

# Useful Web Resources





## Respiratory Related Sites

---

### **West Park Healthcare Centre**

Includes online e-learning modules, example:

- Respiratory Anatomy and Physiology
- Tracheal Suctioning and Manual Ventilation
- Tracheostomy Tubes and Stoma Care
- Introduction to Long Term Mechanical Ventilation (Invasive)

<http://www.ltvcoe.com>

### **The Institute for Rehabilitation Research and Development (The Rehabilitation Centre Ottawa)**

Includes “Respiratory Protocols for SCI and Neuromuscular Diseases”:

- Anatomy and Physiology
- Clinical Pathway
- Interventions (LVR with bag, MI-E, ventilator, and GPB)
- CoughAssist™ - New Generation of MI-E
- Mechanical Insufflation/Exsufflation Policy
- Lung Volume Recruitment with Resuscitation Bag Policy

<http://www.irrd.ca/education/>

### **The Ventilator Equipment Pool**

<http://www.ontvep.ca/>

### **The Ministry of Health & Long-Term Care, Assistive Devices Program, Respiratory Devices Category Administration Manual (June 2007)**

[http://www.health.gov.on.ca/english/providers/pub/adp/resp\\_manual\\_20070627.pdf](http://www.health.gov.on.ca/english/providers/pub/adp/resp_manual_20070627.pdf)

### **Aaron’s Tracheostomy Page**

A web site that provides information about tracheostomy

<http://www.tracheostomy.com/>



## Information on Diseases

---

### **ALS Society of Canada**

<http://www.als.ca>

### **Chronic Obstructive Airway Disease (COPD)-Canadian Lung Association**

[http://lung.ca/diseases-maladies/copd-mpoc\\_e.php](http://lung.ca/diseases-maladies/copd-mpoc_e.php)

### **Cystic Fibrosis**

<http://www.cysticfibrosis.ca>

### **Multiple Sclerosis Society of Canada**

<http://www.mssociety.ca/en/default.htm>

### **Muscular Dystrophy of Canada**

<http://www.muscle.ca>

### **Ontario March of Dimes/March of Dimes Canada**

<http://www.marchofdimes.ca/dimes>

### **Post Polio Health International**

<http://www.post-polio.org>

### **Spinal Muscular Atrophy**

<http://www.smafoundation.org>

## Government Listings and Publications

---

### **Assistive Devices Program (Ontario Ministry of Health & Long Term Care)**

[http://www.health.gov.on.ca/english/public/program/adp/adp\\_mn.html](http://www.health.gov.on.ca/english/public/program/adp/adp_mn.html)

### **ADP Respiratory Manual**

[http://www.health.gov.on.ca/english/providers/program/adp/product\\_manuals/respiratory\\_devices.pdf](http://www.health.gov.on.ca/english/providers/program/adp/product_manuals/respiratory_devices.pdf)

### **How to Hand Wash**

[http://www.health.gov.on.ca/en/ms/handhygiene/video/hand\\_wash.aspx](http://www.health.gov.on.ca/en/ms/handhygiene/video/hand_wash.aspx)

### **Best Practices for Hand Hygiene in all Healthcare Settings**

[http://www.health.gov.on.ca/english/providers/program/infectious/diseases/best\\_prac/bp\\_hh\\_20080501.pdf](http://www.health.gov.on.ca/english/providers/program/infectious/diseases/best_prac/bp_hh_20080501.pdf)

### **Health Canada: Health Products and Food Branch**

<http://www.hc-sc.gc.ca/index-eng.php>

### **Ontario's Community Care Access Centres**

[http://www.health.gov.on.ca/english/public/contact/ccac/ccac\\_mn.html](http://www.health.gov.on.ca/english/public/contact/ccac/ccac_mn.html)

## Associations/Agencies

---

**Canadian Paraplegic Association Ontario**

<http://www.cpaont.org>

**Canadian Sleep Society**

<http://www.css.to>

**College of Physicians and Surgeons of Ontario**

<http://www.cpso.on.ca>

**College of Respiratory Therapists of Ontario**

<http://www.crto.on.ca>

**Canadian Society of Respiratory Therapists**

<http://www.csrt.com>

**International Ventilator Users Network**

<http://www.ventusers.org>

**Ontario Hospital Association**

<http://www.oha.com>

**Respiratory Therapy Society of Ontario**

<http://www.rtso.ca/>

**The BC Association for Individualized Technology and Supports for People with Disabilities:  
Home of the Provincial Respiratory Outreach Program (PROP)**

<http://www.bcits.org/default.htm>

**The Canadian Lung Association**

<http://www.lung.ca>

**The Ontario Lung Association**

<http://www.on.lung.ca>

## Home/Long Term Ventilation Education

---

### **AARC Clinical Practice Guideline**

#### **Long-Term Invasive Mechanical Ventilation in the Home – 2007 Revision & Update**

<http://www.rcjournal.com/cpgs/pdf/08.07.1056.pdf>

### **AARC Clinical Practice Guideline**

#### **Providing Patient and Caregiver Training**

<http://www.rcjournal.com/cpgs/pcgtcpg.html>

### **AARC Clinical Practice Guideline**

#### **Training the Health-Care Professional for the Role of Patient and Caregiver Education**

<http://www.rcjournal.com/cpgs/thcpcpg.html>

### **AARC Clinical Practice Guideline**

#### **Pulse Oximetry**

<http://www.rcjournal.com/cpgs/pulsecpg.html>

### **Battery University is an on-line resource that provides practical battery knowledge**

<http://www.batteryuniversity.com>

### **Emergency Management Ontario: Emergency Preparedness Guide for People with Disabilities/Special Needs**

[http://www.emergencymanagementontario.ca/stellent/idcplg/webdav/Contribution%20Folders/emo/documents/Disability%20Guide\\_Eng.pdf](http://www.emergencymanagementontario.ca/stellent/idcplg/webdav/Contribution%20Folders/emo/documents/Disability%20Guide_Eng.pdf)

<http://www.getprepared.ca>

### **IVUN-Home Ventilator Guide**

<http://www.ventusers.org/edu/HomeVentGuide.pdf>

### **The Institute for Rehabilitation Research and Development: The Rehabilitation Centre, Ottawa: Respiratory Protocols for Spinal Cord Injuries and Neuromuscular Disease**

<http://www.irrd.ca/education/default.asp>

### **The Toronto East General Hospital Progressive Weaning Centre Provincial Centre of Excellence**

[http://www.tegh.on.ca/bins/content\\_page.asp?cid=3-2850&lang=1&pre=view](http://www.tegh.on.ca/bins/content_page.asp?cid=3-2850&lang=1&pre=view)

**West Park Healthcare Centre Long-Term Ventilation Centre of Excellence: On-line e-learning modules**

<http://www.ltvcoe.com/index.html>

**Chronic Ventilation Strategy Task Force: Final Report, June 30, 2006**

[http://www.health.gov.on.ca/english/providers/program/critical\\_care/docs/report\\_cvtg.pdf](http://www.health.gov.on.ca/english/providers/program/critical_care/docs/report_cvtg.pdf)

## Vendors

---

**The Porta-Lung**

<http://portalung.com/index.htm>

**Breathing Pacemakers: Avery Biomedical**

<http://www.averylabs.com/index.html>

**Diaphragm Pacing System: Synapse Biomedical**

<http://www.synapsebiomedical.com/products/neurx.shtml>

**Cough Assist Device**

<http://www.coughassist.com>

**Respironics**

<http://www.healthcare.philips.com/main/homehealth/index.wpd>

**Resmed Corporation**

<http://www.resmed.com/en-en>

**Fisher & Paykel HealthCare**

<http://www.fphcare.com>

**Carestream Medical**

<http://www.carestream.com>

**Draeger Medical-Canada**

[http://www.draeger.com/CA/en\\_US/](http://www.draeger.com/CA/en_US/)

**Quadromed Inc.**

<http://www.quadromed.com/en/index.html>

**Passy-Muir Tracheostomy and Speaking Valves**

<http://www.passy-muir.com>

**Bivona Tracheostomy Tubes**

<http://www.smiths-medical.com/catalog/bivona-tracheostomy-tubes>

**Shiley® Tracheostomy Tubes**

<http://www.nellcor.com/prod/list.aspx?S1=AIR&S2=TTA>

**Instrumentation Industries, Inc**

<http://www.iiimedical.com>

**Intersurgical Complete Respiratory Systems**

<http://www.intersurgical.com>

**Hans Rudolph Inc.**

<http://www.rudolphkc.com>

**DeVilbiss Healthcare**

<http://www.devilbisshealthcare.com>

**Cardinal Health**

<http://www.cardinalhealth.com>

**Covidien**

<http://www.covidien.com>

**Lifetronics**

<http://www.lifetronics.com>

**Advance for Managers of Respiratory Care**

**At-a glance charts detailing various interface/mask products available**

[http://respiratory-care-manager.advanceweb.com/Sharedresources/advanceforMRC/Resources/DownloadableResources/MR040108\\_p64AirwayBG.pdf](http://respiratory-care-manager.advanceweb.com/Sharedresources/advanceforMRC/Resources/DownloadableResources/MR040108_p64AirwayBG.pdf)

## Section #4: Appendices

### Appendix A

Assistive Devices Program  
Equipment/Supply Authorization Form (Sample)

### Appendix B

Quick Reference Guide to LTV® 900, 950 & 1000 Series Ventilators

### Appendix C

Quick Reference Guide to LTV® 1200/1150 Series Ventilators





## Section #4: Appendices

### Appendix A

Assistive Devices Program

Equipment/Supply Authorization Form (Sample)

### Appendix B

Quick Reference Guide to LTV® 900, 950 & 1000 Series Ventilators

### Appendix C

Quick Reference Guide to LTV® 1200/1150 Series Ventilators



# Appendix A Equipment/Supply Authorization Form (Sample)

Ontario Ministry of Health Assisted Devices Branch Telephone: 1-800-387-2031  
75 Stine Street, Toronto, Ontario M5S 1M5 Fax: 416-327-8187  
North York City Hall 4th Floor, Toronto, Ontario M2N 2G5 Fax: 416-327-8187  
EA 11378242  
Equipment/Supply Authorization

Please read instructions prior to completion. Please hand in one completed multiple copies.

**Section 1 - Registrational Information (to be completed by Applicant or Agent)**

Full name: \_\_\_\_\_ (Date of birth (month/day/year)) \_\_\_\_\_  
City, town or village: \_\_\_\_\_ Postal code: \_\_\_\_\_ Telephone no.: \_\_\_\_\_  
I am requesting medical assistance benefits:  yes  no  
If yes, check one only:  Ontario Works (OW)  Ontario Disability Support Program (ODSP)  Assistance to Children with Severe Disabilities (ACSD)

Primary diagnosis: \_\_\_\_\_ Date of surgery (month/day/year): \_\_\_\_\_  
Secondary diagnosis: \_\_\_\_\_  
Surgical procedure (if applicable): \_\_\_\_\_  
Please indicate on this form the date of surgery (month/day/year) and the date of the last medical assessment (month/day/year) if applicable.

Please indicate on this form the date of surgery (month/day/year) and the date of the last medical assessment (month/day/year) if applicable.

Plate Imprint: \_\_\_\_\_  
Signature of Applicant or Agent: \_\_\_\_\_ ADP authorization no.: \_\_\_\_\_  
Date (month/day/year): \_\_\_\_\_

Check if the item has a special ADP status in the device category:  Change in medical condition (specify): \_\_\_\_\_  
 Quantity: \_\_\_\_\_

Quantity	Description of Item, Brand/Model or product equivalent category	Product category	ADP category no.	Vendor's category	City	Postal code	Year used to: _____

I hereby certify that I have seen the above named person and that I have witnessed the equipment/expense described in Section 3 above, based on my assessment of this individual's medical requirements.

Signature of ADP Registered Administrator: \_\_\_\_\_ Date (month/day/year): \_\_\_\_\_  
ADP registration no.: \_\_\_\_\_  
Signature of ADP Registered Dispenser or Health-Care Provider: \_\_\_\_\_ Date (month/day/year): \_\_\_\_\_

**Section 4 - To be completed by Applicant or Agent**

I hereby certify that this is a request of Ontario and/or one of the designated provinces as defined in Section 2 above. I do not have another request for similar services currently funded by ADP and/or one of the designated provinces or ADP may be a recipient of similar services in connection of the above.

I certify that each item to be requested is for personal use in the community and that I may obtain the services from the above ADP registered providers, or directly from ADP.

I certify that the information on this form is true, correct and complete to the best of my knowledge. I understand the request for approval by ADP and an expense for the above equipment/expense. I understand the release of the above information to the Ministry of Health, its agents, the ADP program and other authorized persons and the designated provinces.

I consent to the "indirect collection" by ADP on behalf of the Ministry of Health of the applicant's name, address, health number and Equipment/Supply Authorization number where such information is required by the Ministry to process the claim.

I consent to the collection and disclosure of medical and non-medical information by the Assisted Devices Branch (ADB) to the Workplace Safety & Insurance Board (WSIB), and by the WSIB to the ADB, to determine my eligibility to receive funding assistance from the ADB.

Signature of applicant or agent: \_\_\_\_\_ Date (month/day/year): \_\_\_\_\_

**Section 5 - To be completed by Vendor**

Vendor's registration no.: \_\_\_\_\_ I hereby certify the information on this form is true, correct and complete to the best of my knowledge and that I am registered to provide the goods and services requested on this form to the Ontario Health Services and Programs (OHS) program.

Vendor's address: \_\_\_\_\_  
Signature: \_\_\_\_\_ Date (month/day/year): \_\_\_\_\_

Vendor's signature: \_\_\_\_\_ Date (month/day/year): \_\_\_\_\_

Part 1 - Assistive Devices Program





Ministry of Health and Long-Term Care

Assistive Devices Branch
7th floor, 5700 Yonge Street
NORTH YORK ON M2M 4K5

Toll Free 1 800 268-6021
TDD (Toll Free) 1 800 387-5559
Toronto Area 416 327-8804
Fax 416 327-8192

EA 11378242
Equipment/Supply Authorization

Please read instructions prior to completion. Press hard, you are completing multiple copies.

Section 1 - Biographical Information (to be completed by Applicant or Agent)

Last name of applicant (please print) First name Initials Date of birth (d/m/y) Sex M F

Apt. no. Address

City, town or village Postal code Area code Telephone no. Health no. Version

I am receiving social assistance benefits. yes no

If yes, check one only:

- Ontario Works (OW) Ontario Disability Support Program (ODSP) Assistance to Children with Severe Disabilities (ACSD)

Section 2 - Diagnosis and Equipment Type (to be completed by Prescriber)

Primary diagnosis

Secondary diagnosis

Surgical procedure (if applicable) Date of surgery (d/m/y)

Instructions, special needs

Please ensure all information is provided

Plate Imprint

Health insurance billing no.

I certify that the above named person has a long term physical disability and/or illness and medically requires the use of the equipment for other than the exclusive use of sports, school or work.

Prescriber name (please print)

Area code Telephone no. Date (d/m/y) Prescriber's signature ADP prior authorization no.

Section 3 - Equipment/Supplies Required (to be completed by ADP Registered Authorizer)

- Check if the client has accessed ADP before for this device category Change in medical condition (specify) Growth/Atrophy

Table with columns: Quantity authorized, Description of item: Brand/Model or product equivalent category, Product equivalent category, ADP catalogue no., Vendor to complete (Qty. supplied, Total cost (\$)), ADP use only

I hereby certify that I have seen the above named person and that I have authorized the equipment/supplies described in Section 3 above, based on my assessment of this individual's medical requirements.

Signature of ADP Registered Authorizer Area code Telephone no.

Date (d/m/y) ADP authorizer registration no. ADP clinic registration no.

ADP registration no. Signature of ADP Registered Dispenser or Rehabilitation Assessor Date (d/m/y)

Total cost

Less amount paid by:

- Applicant Agent

Amount billed to ADP

Section 4 - To be completed by Applicant or Agent

I hereby certify that I am a resident of Ontario and in need of the equipment prescribed as in Section 3 above. I do not have similar equipment in working order previously funded by ADP and I understand the vendor or ADP may bill me for equipment obtained in contravention of the above.

I understand that I am free to go to any registered vendor in the community and that I may obtain the locations of these vendors from the above ADP registered authorizers, or directly from the Assistive Devices Program.

I certify that the information on this form is true, correct and complete to the best of my knowledge. I understand the rules of eligibility for ADP and I am eligible for the above supplies/equipment. I authorize the release of the above information to the Ministry of Health, its agents the ADP registered vendor I have chosen and my insurance company.

I consent to the "indirect collection" by ADP vendors on behalf of the Ministry of Health of the applicant's name, address, health number and Equipment/Supply Authorization number where such information is required by the Ministry to process this claim.

I consent to the collection and disclosure of medical and non-medical information by the Assistive Devices Branch (ADB) to the Workplace Safety & Insurance Board (WSIB), and by the WSIB to the ADB, to determine my eligibility to receive funding assistance from the ADB.

Signature of applicant or agent Date (d/m/y)

Section 5 - To be completed by Vendor

Vendor's name Vendor's registration no.

Vendor's address

I hereby certify that the information on this form is true, correct and complete to the best of my knowledge and that the equipment /supplies as listed have been provided to the above person by

Vendor's signature Date (d/m/y)



Appendix B  
Quick Reference Guide for  
LTV<sup>®</sup> 900, 950 & 1000 Series Ventilators

***PulmoneticSystems***<sup>®</sup>  
*Innovations For Life*

**LTV<sup>®</sup> Series Ventilators**  
(LTV<sup>®</sup> 900, 950, and 1000)  
Quick Reference Guide

P/N 10674, Rev. H



***Pulmonetic***Systems®

*Innovations For Life*

**LTV® Series Ventilators**  
**(LTV® 900, 950, and 1000)**  
**Quick Reference Guide**

P/N 10674, Rev. H



# TABLE OF CONTENTS

<b>Front and Side Panel Reference .....</b>	<b>1</b>
Front Panel Display and Description.....	1
Side Panel Descriptions.....	3
<b>Turning the Ventilator On and Off .....</b>	<b>5</b>
Turning the Ventilator On .....	5
Turning the Ventilator Off .....	6
<b>Ventilator Checkout Tests .....</b>	<b>7</b>
Alarm Test .....	8
Display Test.....	9
Control Test.....	10
Leak Test.....	11
Vent Inop Alarm Test.....	12
Set Defaults.....	13
Exit .....	14
<b>Variable Controls.....</b>	<b>15</b>
<b>Setting Up Modes of Ventilation .....</b>	<b>17</b>
Setting Up Control Mode .....	17
Setting Up Assist/Control Mode.....	19
Setting Up SIMV Mode.....	21

P/N 10674, Rev. H

LTV® Series Ventilators

iii

Setting Up CPAP Mode .....	23
Setting Up NPPV Mode .....	25
<b>Monitored Data .....</b>	<b>27</b>
<b>Extended Features .....</b>	<b>29</b>
<b>Using AC/DC Power .....</b>	<b>57</b>
Using the AC Adapter .....	57
Using an External DC Power Source.....	58
<b>Power Displays and Indicators .....</b>	<b>59</b>
<b>Attaching a Breathing Circuit.....</b>	<b>63</b>
<b>Oxygen Computer Chart.....</b>	<b>65</b>
<b>Alarms .....</b>	<b>67</b>

P/N 10674, Rev. H

LTV® Series Ventilators

iv

## FRONT AND SIDE PANEL REFERENCE

### Front Panel Display and Description

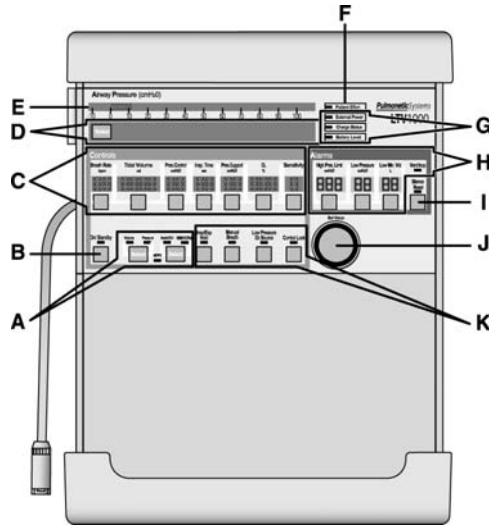

P/N 10674, Rev. H

LTV® Series Ventilators

1

- A - **Mode and Breath Selection** – Selects ventilation modes. Selects breath types.
- B - **Power** – Turns ventilator “On” or to “Standby.”
- C - **Variable Control Settings** – Sets ventilation characteristics, such as Tidal Volume and Breath Rate.
- D - **Display Window** – Displays Alarm Messages, Monitored Data, Extended Features menu.
- E - **Airway Pressure Display** – Displays real-time airway circuit pressure.
- F - **Patient Effort Indicator** – LED is lit briefly each time a patient trigger is detected.
- G - **Power Source** – Displays power source and charge levels.
- H - **Variable Alarm Settings** – Sets variable alarm levels.
- I - **Alarm Silence/Reset** – Silences audible alarms. Clears visual alarms.
- J - **Set Value Knob** – Changes variable control settings. Navigates Extended Features menu.
- K - **Special Controls** – Activates special controls such as Manual Breath, Low Pressure O<sub>2</sub> Source, Insp/Exp Hold or Control Lock feature.

P/N 10674, Rev. H

LTV® Series Ventilators

2

## FRONT AND SIDE PANEL REFERENCE

### Side Panel Descriptions

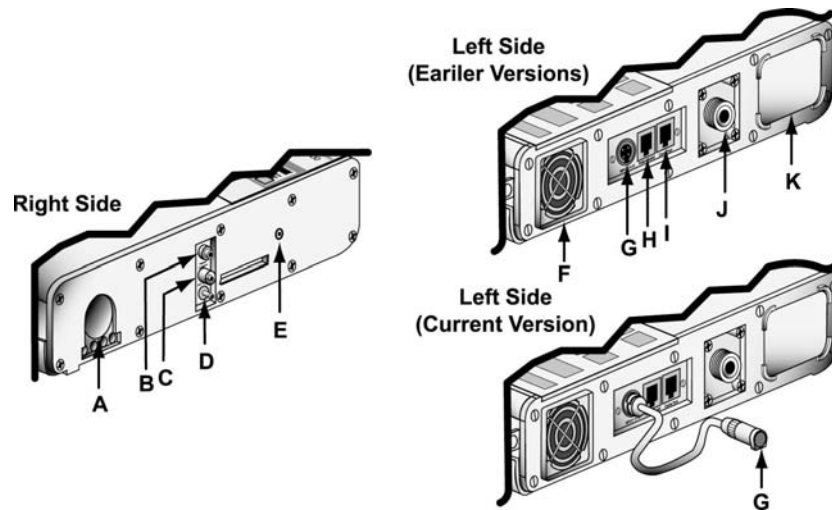

P/N 10674, Rev. H

LTV® Series Ventilators

3

- A - **22mm Outlet Port** – Patient Breathing Circuit outlet port.
- B - **Flow Xducer** – Flow Transducer high pressure sensing port.
- C - **Flow Xducer** – Flow Transducer low pressure sensing port.
- D - **Exh Valve** – Exhalation Valve drive line port.
- E - **Alarm Sounder Port**
- F - **Cooling Fan**
- G - **DC Input** – External DC power port (earlier version)  
or DC power port pigtail connector (current version).
- H - **Patient Assist** – Patient Assist Call jack.
- I - **Comm Port** – Communications port.
- J - **O<sub>2</sub> Inlet** – Oxygen Inlet fitting.
- K - **Filter** – Air Inlet.

P/N 10674, Rev. H

LTV® Series Ventilators



4

## TURNING THE VENTILATOR ON AND OFF

---

### Turning the Ventilator On

To turn the LTV<sup>®</sup> ventilator on:

- 1) Connect the ventilator to an external power source:
  - The AC power adapter may be used or the ventilator may be connected to an external battery.
  - **If you do not connect the ventilator to an external power source, it will operate from the internal battery.**
- 2) Press and release the **On/Standby** button. The ventilator will commence operation:
  - The **On/Standby** LED is lit and the Power On Self Tests (POST) are run. During POST;
    - The front panel displays are illuminated.
    - Verify the audible alarm is activated for 1 second (only on ventilators with a  symbol on the back panel label).
    - Verify a confirming audible chirp is activated (only on ventilators with a  symbol on the back panel label).
- 3) Once POST is successfully completed, the ventilator begins operating using the stored control settings.



### Turning the Ventilator Off

To turn the LTV<sup>®</sup> ventilator off:

- 1) **Disconnect the patient from the ventilator.**
- 2) Press and hold the **On/Standby** button for 3 seconds. The ventilator ceases operating, the audible alarm sounds continuously and the **Vent Inop** LED is lit.
- 3) Press the **Silence/Reset** button to silence the audible alarm.
  - Verify a confirming audible chirp is activated immediately after the alarm is silenced (only on ventilators with a  symbol on the back panel label).
- 4) The ventilator continues to charge the internal battery as long as it is connected to an external power source.

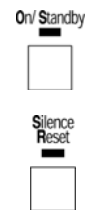

**Note:** The **Vent Inop** LED will remain lit for a minimum of 5 minutes and does not affect battery life.

## VENTILATOR CHECKOUT TESTS

---

**WARNING** - Disconnect the patient from the ventilator prior to running the Ventilator Checkout tests and ventilate the patient using an alternative method. The ventilator does not deliver gas during the Ventilator Checkout tests.

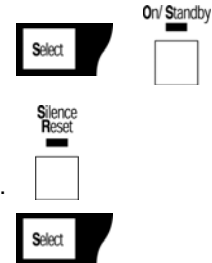

### To enable the Ventilator Checkout menu:

- 1) Begin with the ventilator in Standby mode (off) and connected to a valid AC power source.
  - Verify that the **External Power** and **Charge Status** LEDs are illuminated.
- 2) Press and hold the Monitor **Select** button. While holding the **Select** button, press the **On/Standby** button.
  - **REMOVE PTNT** alarm message is displayed and an audible alarm is sounded.
- 3) Clear the alarm by pressing the **Silence/Reset** button.
  - Audible alarm is silenced and **VENT CHECK** is displayed.
- 4) Press the **Select** button to move to the first test.
  - The first Ventilator Checkout Test, **ALARM**, is displayed.



## Alarm Test

The alarm Test is used to verify that the audible alarm is working correctly.

- 1) Press the **Select** button while **ALARM** is displayed. 
- 2) Verify the audible alarm is sounded.
  - If a Patient Assist Call System or Remote Alarm is connected via the ventilator's Patient Assist Port, verify the device also activates (audible/visual), as specified by its manufacturer.
- 3) When the alarm has sounded for at least 2 seconds, press the **Select** button again. 
- 4) For ventilators with an audio sound symbol (🔊) on the back panel label, verify a confirming audible chirp occurs after the alarm is silenced.



## Ventilator Checkout Tests

---

### Display Test

The display Test is used to verify that the ventilator displays are working correctly.



#### To run the Display Test:

- 1) Press the **Select** button while **DISPLAY** is displayed. 
- 2) All segments of the 7-segment control displays, all dots of the dot-matrix window displays and all LEDs are illuminated.
  - The **External Power** and **Charge Status** LEDs are tested and verified when the AC adapter is connected to the ventilator (see page 7).
  - The **Vent Inop** LED is tested and verified during the Vent Inop Alarm Test (see page 12).
- 3) To end the display test, press the **Select** button again and the next menu item is displayed. 

### Control Test

The Control Test is used to verify that the ventilator buttons and controls are working correctly.

#### To run the Control Test:

- 1) Press the **Select** button while **CONTROL** is displayed. 
- 2) **SELECT** is displayed in the display windows.
- 3) To test each control, press the button. The name of the button is displayed in the display window. To test the **Set Value** knob, turn it clockwise and counterclockwise. The direction of rotation is displayed in the display window. 
- 4) To exit the control test, press the **Select** button again and the next menu item is displayed. 



## Ventilator Checkout Tests

---

### Leak Test

The Leak Test is used to test the patient circuit for leaks. The patient circuit should be tested with all accessories, such as humidifiers or water traps, in place.



#### To run the Leak Test:

- 1) Cap or otherwise occlude the patient circuit wye.
- 2) Press the **Select** button while **LEAK** is displayed. 
  - To perform the Leak Test, the ventilator closes the exhalation valve, sets the flow valve to a near-closed state, elevates the turbine motor speed and elevates the circuit pressure.
  - At the conclusion of the test, the display shows **LEAK xx.x pass** or **fail**, where **xx.x** is the measured leak.
- 3) To exit the Leak Test, press the **Select** button again and the next menu item is displayed. 

### Vent Inop Alarm Test

The Vent Inop Alarm Test is used to verify that the Inop Alarm is working correctly.

#### To run the Vent Inop Alarm Test:

- 1) To run the Vent Inop Alarm Test, the ventilator must be on (running) for at least 60 seconds and the Ventilator Checkout menu must be enabled.
- 2) Turn the ventilator off by pressing and holding the **On/Standby** button for a minimum of 3 seconds. **DO NOT** press the **Silence/Reset** button. 
- 3) Observe the ventilator for 15 seconds.
  - Listen for the alarm tone
  - Watch the Vent Inop LED
- 4) For all ventilators, verify that both of the following conditions existed;
  - The alarm tone sounded continuously for the full 15-second duration.
  - The Vent Inop LED illuminated continuously for the full 15-second duration.
- 5) If a Patient Assist Call System or Remote Alarm is connected via the ventilator's Patient Assist Port, verify the device also activates (audible/visual), as specified by its manufacturer.
- 6) Silence the alarm by pressing the **Silence/Reset** button. 
- 7) For ventilators with an audio sound symbol (🔊) on the back panel label, verify the following condition existed;
  - A confirming audible chirp occurred after the alarm was silenced.

## Ventilator Checkout Tests

---

When the Ventilator Checkout Tests have been completed, proceed to **Exit** for instructions to exit the vent check mode, or see below concerning the use of the Set Defaults option.

### Set Defaults

The Set Defaults option is used to reset user settable Controls and Extended Features settings to their factory-set default values (see the *LTV<sup>®</sup> 1200 Series Ventilators Operator's Manual* for factory-set default values).

#### To set the default values:

- 1) Turn the **Set Values** knob until **EXIT** is displayed and press the **Select** button.
  - **VENT CHECK** is displayed
- 2) Turn the **Set Values** knob until **VENT OP** is displayed and press the **Select** button.
- 3) Turn the **Set Values** knob until **DEFAULTS** is displayed and press the **Select** button.
  - **SET DEFAULTS** is displayed.
- 4) Press the **Select** button while **SET DEFAULTS** is displayed.
  - Except for the Language selected and the Date/Time settings and format, all user settable Controls and Extended Features options are reset to their factory-set default values.
  - A **DEFAULTS SET** alarm will be generated the next time the ventilator is powered up in normal ventilation mode (see **Alarms, DEFAULTS SET** for additional information).



### Exit

To return to any of the **VENT CHECK** tests, turn the **Set Value** knob until the desired test is displayed.

#### To Exit:

- 1) Press the **Select** button while **EXIT** is displayed, and **VENT CHECK** is displayed.
- 2) Turn the **Set Value** knob until **EXIT** is displayed again.
- 3) Press the **Select** button.



The Ventilator performs a Self Test (POST) and resumes normal operation.



## VARIABLE CONTROLS

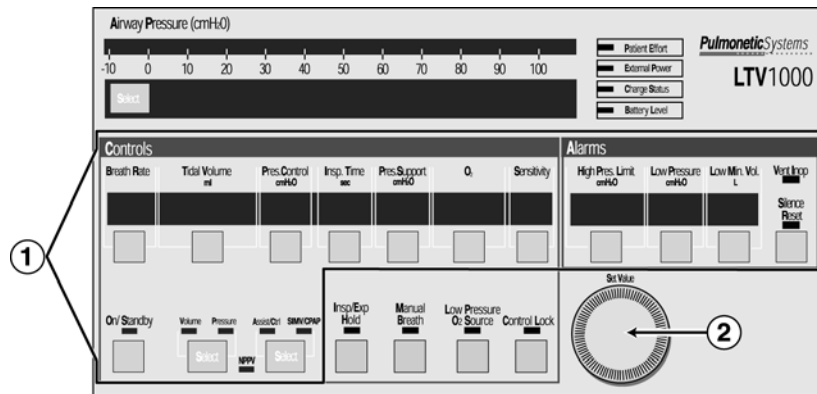



P/N 10674, Rev. H

LTV® Series Ventilators

15

### To set a variable control:

- 1) Select the control by pressing the associated button. The display for the selected control will be displayed at normal brightness and all other control displays will be dimmed.
- 2) Change the control value by rotating the **Set Value Knob**. Rotate clockwise to increase and counter-clockwise to decrease the value. 
- 3) The new control value goes into effect when the operator:
  - Presses the selected button again, or
  - Selects another control, or
  - Presses the **Control Lock** button, or 
  - Waits 5 seconds

All controls will then return to their normal brightness.

P/N 10674, Rev. H

LTV® Series Ventilators

16

## SETTING UP MODES OF VENTILATION

### Setting Up Control Mode

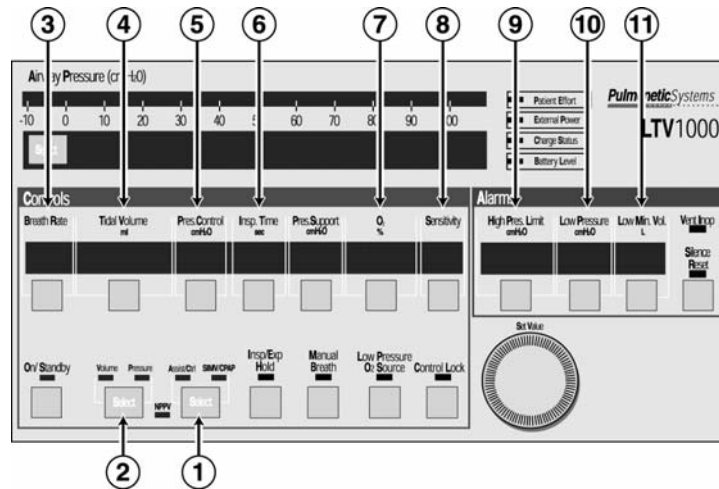

#### To set the ventilator up in Control mode:

- 1) Press the **Select** button twice to toggle the modes between **Assist/Control** and **SIMV/CPAP**. Select the **Assist/Control** mode.
- 2) Press the **Select** button twice to toggle between **Volume** and **Pressure** ventilation. Select **Volume** or **Pressure**, as desired. (Not available on the LTV® 900.)
- 3) Set the **Breath Rate**.
- 4) If **Volume** ventilation is selected, set the **Tidal Volume**. The calculated peak flow **Vcalc** is displayed in the window while **Tidal Volume** is being changed.
- 5) If **Pressure** ventilation is selected, set the **Pressure Control**. (Not available on the LTV® 900.)
- 6) Set the **Inspiratory Time**. The calculated peak flow **Vcalc** is displayed in the window while **Inspiratory Time** is being changed. **Vcalc** only applies to volume ventilation.
- 7) Set **O<sub>2</sub>%** (LTV® 1000 only).
- 8) Set the **Sensitivity** to Off (dash "-").
- 9) Set the **High Pressure Limit** alarm.
- 10) Set the **Low Pressure** alarm.
- 11) Set the **Low Minute Volume** alarm.
- 12) Set the **PEEP** control on the exhalation valve.

## SETTING UP MODES OF VENTILATION

### Setting Up Assist/Control Mode

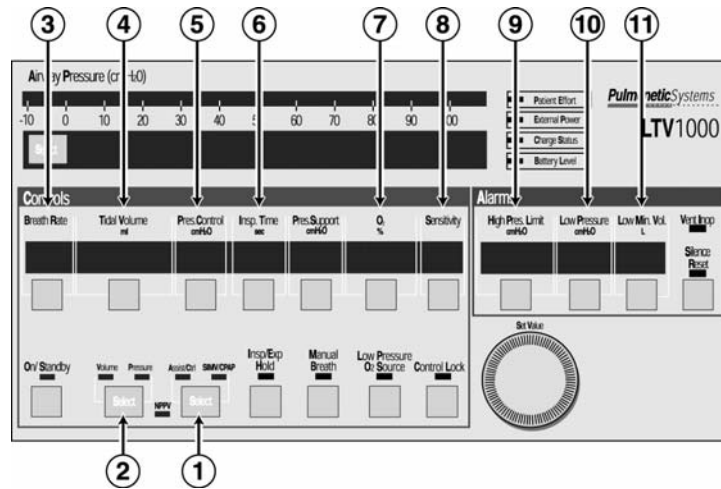

P/N 10674, Rev. H

LTV<sup>®</sup> Series Ventilators

19

#### To set the ventilator up in Assist/Control mode:

- 1) Press the **Select** button twice to toggle the modes between **Assist/Control** and **SIMV/CPAP**. Select the **Assist/Control** mode.
- 2) Press the **Select** button twice to toggle between **Volume** and **Pressure** ventilation. Select **Volume** or **Pressure**, as desired. (Not available on the LTV<sup>®</sup> 900).
- 3) Set the **Breath Rate**.
- 4) If **Volume** ventilation is selected, set the **Tidal Volume**. The calculated peak flow **Vcalc** is displayed in the window while **Tidal Volume** is being changed.
- 5) If **Pressure** ventilation is selected, set the **Pressure Control**. (Not available on the LTV<sup>®</sup> 900.)
- 6) Set the **Inspiratory Time**. The calculated peak flow **Vcalc** is displayed in the window while **Inspiratory Time** is being changed. **Vcalc** only applies to volume ventilation.
- 7) Set **O<sub>2</sub>%**, (LTV<sup>®</sup> 1000 only).
- 8) Set the **Sensitivity** to a setting from 1 to 9.
- 9) Set the **High Pressure Limit** alarm.
- 10) Set the **Low Pressure** alarm.
- 11) Set the **Low Minute Volume** alarm.
- 12) Set the **PEEP** control on the exhalation valve.

P/N 10674, Rev. H

LTV<sup>®</sup> Series Ventilators

20

## SETTING UP MODES OF VENTILATION

### Setting Up SIMV Mode

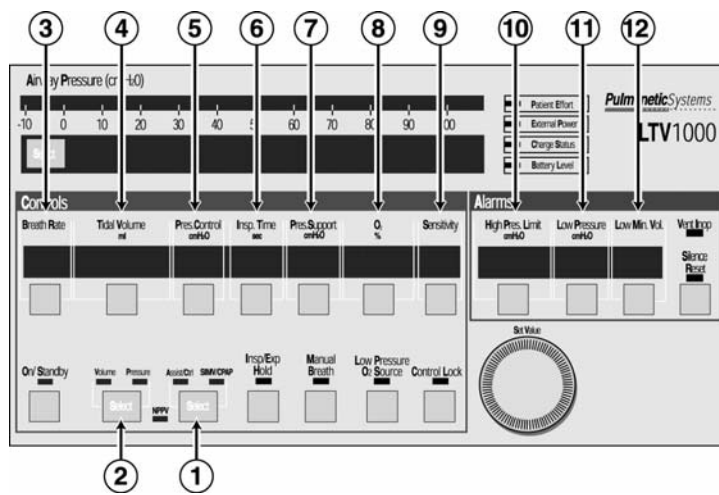

P/N 10674, Rev. H

LTV<sup>®</sup> Series Ventilators

21

#### To set the Ventilator up in SIMV mode:

- 1) Press the **Select** button twice to toggle the modes between **Assist/Control** and **SIMV/CPAP**. Select the **SIMV/CPAP** mode.
- 2) Press the **Select** button to toggle between **Volume** and **Pressure** ventilation. Select **Volume** or **Pressure**, as desired. (Not available on the LTV<sup>®</sup> 900).
- 3) Set the **Breath Rate**.
- 4) If **Volume** ventilation is selected, set the **Tidal Volume**. The calculated peak flow **Vcalc** is displayed in the window while **Tidal Volume** is being changed.
- 5) If **Pressure** ventilation is selected, set the **Pressure Control**. (Not available on the LTV<sup>®</sup> 900.)
- 6) Set the **Inspiratory Time**. The calculated peak flow **Vcalc** is displayed in the window while **Inspiratory Time** is being changed. **Vcalc** only applies to volume ventilation.
- 7) Set the **Pressure Support**, if desired.
- 8) Set **O<sub>2</sub>%** (LTV<sup>®</sup> 1000 only).
- 9) Set the **Sensitivity** to a setting from 1 to 9.
- 10) Set the **High Pressure Limit** alarm.
- 11) Set the **Low Pressure** alarm.
- 12) Set the **Low Minute Volume** alarm.
- 13) Set the **PEEP** control on the exhalation valve.

P/N 10674, Rev. H

LTV<sup>®</sup> Series Ventilators

22

## SETTING UP MODES OF VENTILATION

### Setting Up CPAP Mode

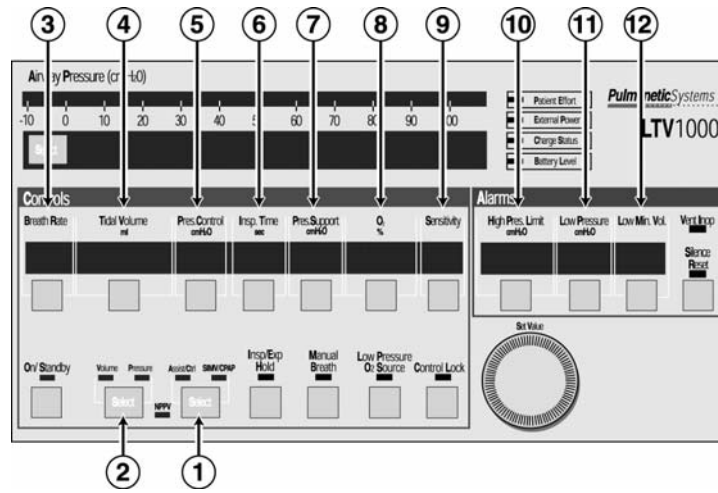

#### To set the ventilator up in CPAP mode:

- 1) Press the **Select** button twice to toggle the modes between **Assist/Control** and **SIMV/CPAP**. Select the **SIMV/CPAP** mode.
- 2) Press the **Select** button twice to toggle between **Volume** and **Pressure** ventilation for Apnea backup. Select **Volume** or **Pressure** for Apnea backup. (Not available on the LTV® 900).
- 3) Set the **Breath Rate** to Off (dashes "- -").
- 4) If **Volume** ventilation is selected, set the **Tidal Volume** for Apnea backup. The calculated peak flow **Vcalc** is displayed in the window while **Tidal Volume** is being changed.
- 5) If **Pressure** ventilation is selected, set the **Pressure Control** for Apnea backup. (Not available on the LTV® 900.)
- 6) Set the **Inspiratory Time** for Apnea backup. The calculated peak flow **Vcalc** is displayed in the window while **Inspiratory Time** is being changed. **Vcalc** only applies to volume ventilation.
- 7) Set the **Pressure Support**, if desired.
- 8) Set **O<sub>2</sub>%** (LTV® 1000 only).
- 9) Set the **Sensitivity** to a setting from 1 to 9.
- 10) Set the **High Pressure Limit** alarm.
- 11) Set the **Low Pressure** alarm for Apnea backup.
- 12) Set the **Low Minute Volume** alarm.
- 13) Set the **PEEP** control on the exhalation valve.

**NOTE:** Although **Tidal Volume**, **Pressure Control** and **Insp Time** are dimmed, they should be set to clinically appropriate levels as the ventilator uses these settings for Apnea back-up ventilation.

## SETTING UP MODES OF VENTILATION

### Setting Up NPPV Mode

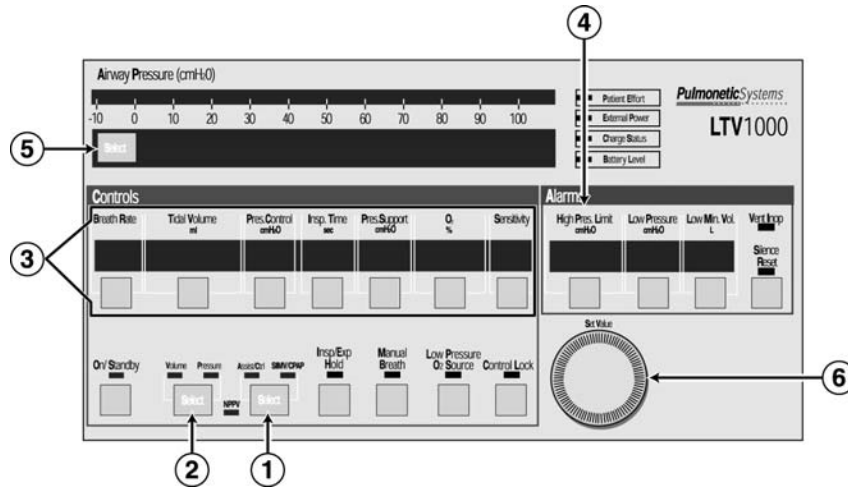

#### To set the Ventilator up in NPPV mode:

- 1) Set the ventilator controls for Control, Assist/Control, SIMV, or CPAP mode, as described in the preceding section.
- 2) Set the ventilator controls for **V**olume or **P**ressure ventilation, as described in the preceding section.
- 3) Set all other ventilation parameters, as described in the previous section.
- 4) Set the High Pressure Limit alarm.
- 5) Enter Extended Features by pressing and holding the Monitor **S**elect button for 3 seconds.
- 6) Turn the **S**et **V**alue knob until **VENT OP** is displayed.
- 7) Press the Monitor **S**elect button.
- 8) Turn the **S**et **V**alue knob until **NPPV Mode** is displayed.
- 9) Press the Monitor **S**elect button.
- 10) Turn the **S**et **V**alue knob until **NPPV On** is displayed.
- 11) Press Monitor **S**elect button.
- 12) The NPPV LED will be illuminated.
- 13) Exit the Extended Features menus by turning the **S**et **V**alue knob until **Exit** is displayed, and pressing **S**elect button until monitored data is displayed in the window.

## MONITORED DATA

---

The monitored data displays may be automatically scrolled or manually scrolled. To cycle through the available monitored data automatically from a halted scan, press the Monitor **Select** button twice. Pressing the **Select** button once while scan is active shall halt scanning and the currently display monitor shall remain in the display window. Each time you press the button once; the next data item in the list will be displayed. To resume scan, press the scan button twice. The monitored data is displayed in the following order.

Display	Description
<b>PIP</b>	Displays the Peak Inspiratory Pressure measured during the inspiratory phase. PIP is not updated for spontaneous breaths.
<b>MAP</b>	Displays a running average of the airway pressure for the last 60 seconds.
<b>PEEP</b>	Displays the pressure in the airway circuit at the end of exhalation.
<b>f</b>	Displays the breaths per minute and includes all breath types.
<b>Vte</b>	Displays the exhaled tidal volume as measured at the patient wye.

Display	Description
<b>VE</b>	Displays the exhaled tidal volume for the last 60 seconds as calculated from the last 8 breaths.
<b>I:E</b>	Displays the ratio between measured inspiratory time and measured exhalation time. Both normal and inverse I:E Ratios are displayed.
<b>Vcalc</b>	Is based on the Tidal Volume and Inspiratory Time settings. Displayed when selected and whenever Tidal Volume or Inspiratory Time is selected for change.

## EXTENDED FEATURES

### Navigating the Extended Features Menus:

**To enter the Extended Features menu** (in normal ventilation mode), press and hold the Monitor **Select** button for three seconds.



**To view the next item in a menu**, turn the **Set Value** knob clockwise.



**To view the previous item**, turn the **Set Value** knob counterclockwise.



**To enter a menu item or select a setting**, press the **Select** button.



**To exit a menu**, turn the **Set Value** knob until the **EXIT** option is displayed, then press the **Select** button or press **Control Lock**.

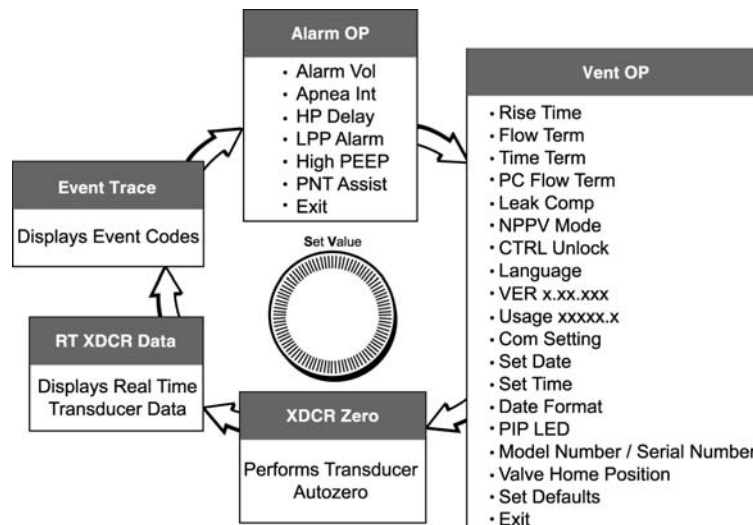





## ***EXTENDED FEATURES***

---

### **Alarm Operations**

#### **Alarm Volume**



After accessing Extended Features, **ALARM OP** is displayed. Press the **Select** button and **ALARM VOL** is displayed.

- 1) Press the **Select** button. 
- 2) **VOL xx dBA** is displayed, where **xx** is the currently set volume.
- 3) Turn the **Set Value** knob until the desired setting is displayed. 
- 4) Press the **Select** button. 

### **Alarm Operations**

#### **Apnea Interval**

After accessing Extended Features, **ALARM OP** is displayed. Press the **Select** button and **ALARM VOL** is displayed. Turn the **Set Value** knob until **APNEA INT** is displayed.

- 1) Press the **Select** button. 
- 2) **APNEA xx sec** is displayed, where **xx** is the currently set Apnea interval.
- 3) Turn the **Set Value** knob until the desired setting is displayed. 
- 4) Press the **Select** button. 

## ***EXTENDED FEATURES***

---

### **Alarm Operations**

#### **High Pressure Alarm Delay**

This menu item is used to select immediate or delayed audible notification for High Pressure alarms.

After accessing Extended Features, **ALARM OP** is displayed. Press the **Select** button and **ALARM VOL** is displayed. Turn the **Set Value** knob until **HP DELAY** is displayed.

- 1) Press the **Select** button. 
- 2) Turn the **Set Value** knob until the desired setting is displayed, **NO DELAY**, **DELAY 1 BRTH**, or **DELAY 2 BRTH**.



- 3) Press the **Select** button.



### **Alarm Operations**

#### **Low Peak Pressure Alarm**

This item is used to select the type of breaths that the Low Pressure Alarm applies to.

After accessing Extended Features, **ALARM OP** is displayed. Press the **Select** button and **ALARM VOL** is displayed. Turn the **Set Value** knob until **LPP ALARM** is displayed.

- 1) Press the **Select** button. 
- 2) Turn the **Set Value** knob until the desired setting is displayed, **ALL BREATHS**, **VC/PC ONLY**.



- 3) Press the **Select** button.



## EXTENDED FEATURES



---

### Alarm Operations

#### High PEEP Alarm<sup>1</sup>

This menu item is used to set a high PEEP alarm value. When the current PEEP value exceeds the set high PEEP alarm value, an audible alarm will be sounded and a flashing **HIGH PEEP** message will be displayed.

After accessing Extended Features, **ALARM OP** is displayed. Press the **Select** button and **ALARM VOL** is displayed. Turn the **Set Value** knob until **HIGH PEEP** is displayed.

- 1) Press the **Select** button. 
- 2) Turn the **Set Value** knob until the desired setting is displayed, **HI PEEP OFF** or **PEEP xx cmH<sub>2</sub>O**.
- 3) Turn the **Set Value** knob until the desired setting is displayed.
- 4) Press the **Select** button. 



---



<sup>1</sup> The HIGH PEEP alarm is only available on ventilators with software version 3.15 or higher installed.

### Alarm Operations

#### PNT Assist<sup>2</sup>

This menu item is used to configure the patient Assist Port output signal to be generated for use with remote alarm systems.

After accessing Extended Features, **ALARM OP** is displayed. Press the **Select** button and **ALARM VOL** is displayed. Turn the **Set Value** knob until **PNT ASSIST** is displayed.

- 1) Press the **Select** button. 
- 2) Turn the **Set Value** knob until the desired setting is displayed, **NORMAL** or **PULSE**.
- 3) Press the **Select** button. 



---

<sup>2</sup> The PNT ASSIST option is only available on ventilators with software version 3.15 or higher installed.

## ***EXTENDED FEATURES***

---

### **Alarm Operations**

#### **Exit**

To return to the top of the **ALARM OP** menu:

- 1) Turn the **Set Value** knob until **EXIT** is displayed.
- 2) Press the **Select** button while **EXIT** is displayed





### **Ventilator Operations**

#### **Variable Rise Time**

The variable Rise Time option is used to select the rise time profile for Pressure Control and Pressure Support breaths. The rise time profiles are numbered 1 through 9, where 1 is the fastest rise time and 9 is the slowest rise time.

After accessing Extended Features, **ALARM OP** is displayed. Turn the **Set Value** knob until **VENT OP** is displayed. Press the **Select** button, and **RISE TIME** is displayed.

- 1) Press the **Select** button. 
- 2) **PROFILE x** is displayed, where **x** is the currently set value.
- 3) Turn the **Set Value** knob until the desired Rise Time Profile is displayed.
- 4) Press the **Select** button. 



## EXTENDED FEATURES

---





### Ventilator Operations

#### Variable Flow Termination

The Variable Flow Termination is used to select the percentage of peak flow used for cycling Pressure Support breaths. Pressure Support breaths are cycled from inspiration to exhalation when the flow reaches the set percentage of the peak flow, or when flow goes below 2 lpm.

When Pressure Control Flow Termination is enabled, the Variable Flow Termination setting is used for flow termination of Pressure Control breaths as well.

After accessing Extended Features, **ALARM OP** is displayed. Turn the **Set Value** knob until **VENT OP** is displayed. Press the **Select** button.





- 1) Turn the **Set Value** knob until **FLOW TERM** is displayed. 
- 2) Press the **Select** button. 
- 3) **% OF PEAK xx** is displayed, where **xx** is the current Flow Termination setting.
- 4) Turn the **Set Value** knob until the desired Flow Termination percentage is displayed. 
- 5) Press the **Select** button. 

### Ventilator Operations

#### Variable Time Termination

The Variable Time Termination is used to select maximum inspiratory time for cycling Pressure Support breaths. Pressure Support breaths are cycled from inspiration to exhalation, if this time is reached before the flow reaches the set percentage of the peak flow. When a breath is cycled based on the time setting, the Pressure Support display is flashed briefly.

After accessing Extended Features, **ALARM OP** is displayed. Turn the **Set Value** knob until **VENT OP** is displayed. Press the **Select** button.

- 1) Turn the **Set Value** knob until **TIME TERM** is displayed. 
- 2) Press the **Select** button. 
- 3) **TERM x.x sec** is displayed, where **xx** is the current Time Termination setting.
- 4) Turn the **Set Value** knob until the desired Time Termination is displayed. 
- 5) Press the **Select** button. 

## EXTENDED FEATURES

---



### Ventilator Operations

#### Pressure Control Flow Termination

The Pressure Control Flow Termination option is used to enable or disable flow termination for Pressure Control breaths.

When this option is on, Pressure Control breaths are cycled at the set percentage of peak flow, if it is reached before the set Inspiratory Time elapses. The percentage of peak flow is set in the Variable Flow Termination option.

After accessing Extended Features, **ALARM OP** is displayed. Turn the **Set Value** knob until **VENT OP** is displayed. Press the **Select** button.

- 1) Turn the **Set Value** knob until **PC FLOW TERM** is displayed.
- 2) Press the **Select** button. 
- 3) **PC FLOW ON** or **PC FLOW OFF** is displayed.
- 4) Turn the **Set Value** knob until the desired state is displayed.
- 5) Press the **Select** button. 





### Ventilator Operations

#### Leak Compensation

Use the Leak Compensation option to enable or disable tracking of the Baseline Flow to improve triggering when a circuit leak is present.

When Leak Compensation is on, the system is gradually adjusted to maintain set sensitivity, if the leak is stable and there is no auto cycling.

After accessing Extended Features, **ALARM OP** is displayed. Turn the **Set Value** knob until **VENT OP** is displayed. Press the **Select** button.

- 1) Turn the **Set Value** knob until **LEAK COMP** is displayed.
- 2) Press the **Select** button. 
- 3) **LEAK COMP ON** or **LEAK COMP OFF** is displayed.
- 4) Turn the **Set Value** knob until the desired state is displayed.
- 5) Press the **Select** button. 



## EXTENDED FEATURES

---

### Ventilator Operations

#### NPPV Mode

After accessing Extended Features, **ALARM OP** is displayed. Turn the **Set Value** knob until **VENT OP** is displayed. Press the **Select** button.

1) Turn the **Set Value** knob until the **NPPV MODE** is displayed.



2) Press the **Select** button.



3) **NPPV MODE ON** or **NPPV MODE OFF** is displayed.

4) Turn the **Set Value** knob until the desired state is displayed.



5) Press the **Select** button.



### Ventilator Operations

#### Control Unlock

When the Easy method is selected, unlock the controls by pressing and releasing the **Control Lock** button.

When the Hard method is selected, unlock the controls by pressing and holding the **Control Lock** button for 3 seconds.

After accessing Extended Features, **ALARM OP** is displayed. Turn the **Set Value** knob until **VENT OP** is displayed. Press the **Select** button.

1) Turn the **Set Value** knob until **CTRL UNLOCK** is displayed.



2) Press the **Select** button.



3) **UNLOCK EASY** or **UNLOCK HARD** is displayed.

4) Turn the **Set Value** knob until the desired setting is displayed.



5) Press the **Select** button.



## EXTENDED FEATURES

---

### Ventilator Operations

#### Language Selection

After accessing Extended Features, **ALARM OP** is displayed. Turn the **Set Value** knob until **VENT OP** is displayed. Press the **Select** button.

1) Turn the **Set Value** knob until **LANGUAGE** is displayed.

2) Press the **Select** button.



3) **ENGLISH** or the currently selected language is displayed.

4) Turn the **Set Value** knob until the desired language is displayed.

5) Press the **Select** button.



### Ventilator Operations

#### Software Versions

After accessing Extended Features, **ALARM OP** is displayed. Turn the **Set Value** knob until **VENT OP** is displayed. Press the **Select** button. Turn the **Set Value** knob until **VER xx.xx.xx** is displayed, where **xx.xx.xx** is the current software version.



#### Usage Meter

After accessing Extended Features, **ALARM OP** is displayed. Turn the **Set Value** knob until **VENT OP** is displayed. Press the **Select** button. Turn the **Set Value** knob until **USAGE xxxxx.x** is displayed, where **xxxxx.x** is the current number of hours the ventilator has been in operation.





## EXTENDED FEATURES



---

### Ventilator Operations

#### Communications Setting

The ventilator may be connected to printer, a graphics monitor, or a modem. The Communications Setting option is used to select the communications protocol for data transmission.

After accessing Extended Features, **ALARM OP** is displayed. Turn the **Set Value** knob until **VENT OP** is displayed. Press the **Select** button.

- 1) Turn the **Set Value** knob until **COM SETTING** is displayed.
- 2) Press the **Select** button. 
- 3) **MONITOR** or the currently selected protocol is displayed.
- 4) Turn the **Set Value** knob until the desired protocol is displayed.
- 5) Press the **Select** button. 



### Ventilator Operations

#### Set Date

After accessing Extended Features, **ALARM OP** is displayed. Turn the **Set Value** knob until **VENT OP** is displayed. Press the **Select** button.

- 1) Turn the **Set Value** knob until **SET DATE** is displayed.
- 2) Press the **Select** button. 
- 3) The current date is displayed in the currently selected date format.
- 4) Press the **Control Lock** button to exit, or continue to modify the Date.



#### To modify the Date:

- 1) Press the **Select** button, **YEAR xxxx** is displayed. 
- 2) Turn the **Set Value** knob until the desired year is displayed.
- 3) Press the **Select** button, **MONTH xx** is displayed.
- 4) Turn the **Set Value** knob until the desired month is displayed.
- 5) Press the **Select** button, **DAY xx** is displayed.
- 6) Turn the **Set Value** knob until the desired day is displayed.
- 7) Press the **Select** button to accept the new date.



## EXTENDED FEATURES

---

### Ventilator Operations

#### Set Time

After accessing Extended Features, **ALARM OP** is displayed. Turn the **Set Value** knob until **VENT OP** is displayed. Press the **Select** button.

- 1) Turn the **Set Value** knob until **SET TIME** is displayed.
- 2) Press the **Select** button.



- 3) The current time is displayed.
- 4) Press the **Control Lock** button to exit, or



#### To modify the Time:

- 1) Press the **Select** button, **HOUR xx** is displayed.
- 2) Turn the **Set Value** knob until the desired hour is displayed.
- 3) Press the **Select** button, **MIN xx** is displayed.
- 4) Turn the **Set Value** knob until the desired minute is displayed.
- 5) Press the **Select** button to accept the new time. The seconds are automatically reset to **00**.



### Ventilator Operations

#### Date Format

The Date Format option is used to select the display format for the current date.

After accessing Extended Features, **ALARM OP** is displayed. Turn the **Set Value** knob until **VENT OP** is displayed. Press the **Select** button.

- 1) Turn the **Set Value** knob until **DATE FORMAT** is displayed.
- 2) Press the **Select** button.
- 3) **MM/DD/YYYY** or the currently selected date format is displayed.



- 4) Turn the **Set Value** knob until the desired format is displayed.



- 5) Press the **Select** button.





## EXTENDED FEATURES

---

### Ventilator Operations

#### PIP LED

After accessing Extended Features, **ALARM OP** is displayed. Turn the **Set Value** knob until **VENT OP** is displayed. Press the **Select** button.

- 1) Turn the **Set Value** knob until **PIP LED** is displayed.
- 2) Press the **Select** button. 
- 3) **PIP LED ON** or **PIP LED OFF** is displayed.
- 4) Turn the **Set Value** knob until the desired setting is displayed.
- 5) Press the **Select** button. 



### Ventilator Operations

#### Model Number / Serial Number

After accessing Extended Features, **ALARM OP** is displayed. Turn the **Set Value** knob until **VENT OP** is displayed. Press the **Select** button.

##### To view the LTV<sup>®</sup> model number:

Turn the **Set Value** knob until **LTV XXXX** is displayed, where **XXXX** is the model of the ventilator.



##### To view the LTV<sup>®</sup> serial number:

- 1) Press the **Select** button while **LTV XXXX** is displayed.
  - The serial number is displayed on the left side of the display area as **XXXXXX**, where **XXXXXX** is the serial number of the ventilator.
- 2) Press the **Select** button to return to the model number option.



##### To view LTM<sup>™</sup> compatibility:

- 1) Press the **Select** button while **LTV XXXX** is displayed.
  - **LTM** will be displayed if software and internal hardware in the LTV<sup>®</sup> Ventilator are LTM<sup>™</sup> compatible.
- 2) Press the **Select** button to return to the model number.



## ***EXTENDED FEATURES***

---

### **Ventilator Operations**

#### **Valve Home Position**

After accessing Extended Features, **ALARM OP** is displayed. Turn the **Set Value** knob until **VENT OP** is displayed. Press the **Select** button.

#### **To view the valve home position:**

Turn the **Set Value** knob until **Vhome XXX** is displayed, where **XXX** is the home position for the flow valve installed in the ventilator.



#### **Set Defaults**

The Set Defaults option is only displayed and accessed through the **VENT CHECK** and **VENT MTNCE** menus and is used to reset user settable Controls and Extended Features settings to their factory-set default values. See *Ventilator Checkout Tests, Set Defaults* for instructions on how to set default values and the *LTV® Series Ventilators Operator's Manual* for factory-set default values.

### **Ventilator Operations**

#### **Exit**

#### **To return to the top of the VENT OP menu:**

- 1) Turn the **Set Value** knob until **EXIT** is displayed.
- 2) Press the **Select** button.



#### **XDCR ZERO**

This item is used to view the Transducer Autozero results and schedule the Transducer Autozero to be run (please refer to the Operator's Manual).

## ***EXTENDED FEATURES***

---

### **Ventilator Operations**

#### **RT XDCR DATA**

This menu displays the Real Time Transducer Data (please see the Service Manual for more information).

#### **EVENT TRACE**

This menu displays the Events Codes stored by the ventilator (please see the Service Manual for more information).

### **Ventilator Operations**

#### **Exiting Extended Features**

##### **To return to Monitored Parameters:**

- 1) Turn the **Set Value** knob until **EXIT** is displayed.
- 2) Press the **Select** button. 
- 3) Repeat Steps 1 and 2 until the Monitored Parameters are displayed.



## USING AC/DC POWER

---

### Using the AC Adapter

To run the ventilator from an external AC power source.

- 1) Connect the power jack (straight or 90°) from the AC adapter to the power port (earlier version ventilators) or power port pigtail connector (current version ventilators) on the left side of the ventilator.
- 2) Connect the proper AC power cable (110 or 220 V plug) to the AC power adapter.
- 3) Connect the 110 or 220 V power cable to a suitable power source.

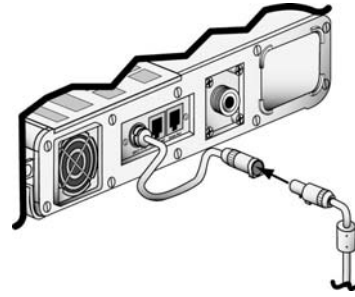

While the ventilator is plugged in, the internal battery is continuously charged.

**CAUTION: Release Button** – To avoid damaging the ventilator or the power connector, press the release button on the connector before removing it from the ventilator power port pigtail connector.

### Using an External DC Power Source

To run the ventilator from an external DC power source.

- 1) Connect the power port of the external DC power adapter cable to the power port on the left side of the ventilator (earlier version ventilators), or the power port pigtail connector (current version ventilators).
- 2) Connect the DC jack to the DC power source.

## POWER DISPLAYS AND INDICATORS

---

### Indicators

#### Battery Level

The Battery Level indicator shows the level of available internal battery power while running from the internal battery.

LED Color	Battery Level	Approximate Battery Time @ nominal settings
Green	Internal battery level is acceptable	45 minutes
Amber	Internal battery level is low	10 minutes
Red	Internal battery level is critically low	5 minutes
Off	Ventilator is running on AC or External Battery	

### Indicators

#### Charge Status

When the ventilator is plugged into an External Power source, it automatically charges the internal battery.

LED Color	Charge Status
Flashing Amber	The ventilator is performing pre-charge qualification testing of the battery prior to starting the charge process. This happens when external power is first applied to the ventilator. The qualification process normally takes a few seconds but may take up to an hour on a deeply discharged battery.
Green	The internal battery is charged to full level.
Amber	The battery has not reached a full charge level and is still charging.
Red	The ventilator has detected a charge fault or internal battery fault. The internal battery cannot be charged. Contact your Pulmonetic Systems Certified Service Technician.

## ***POWER DISPLAYS AND INDICATORS***

---

### **Indicators**

#### **External Power**



The External Power indicator shows the level of external power while the ventilator is operating from an external power source. When the ventilator is running from the internal battery, the External Power indicator is off. When running from external power, the indicator shows the following levels.

<b>LED Color</b>	<b>Power Level</b>
Green	External Power level is acceptable
Amber	External Power level is low

External power may be provided by connecting the ventilator to an external battery or to an external AC power source.

**This page intentionally left blank**



## ATTACHING A BREATHING CIRCUIT

---

### How to attach a patient breathing circuit.

- 1) Connect the main breathing tube to the 22 mm outlet port on the right side of the ventilator.
- 2) Connect the two exhalation flow transducer sense lines to the ports marked **Flow Xducer** on the right side of the ventilator. These are non-interchangeable Luer fittings.
- 3) Connect the Exhalation Valve driver line to the port marked **Exh Valve** on the right side of the ventilator.

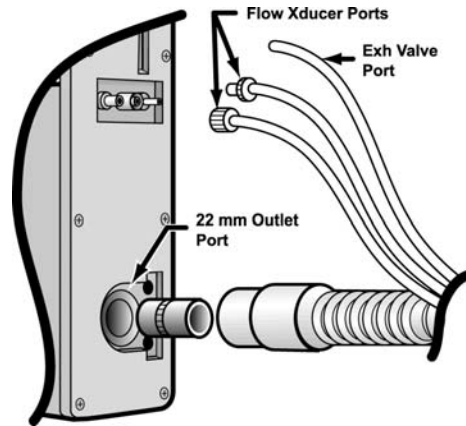

This page intentionally left blank

## OXYGEN COMPUTER CHART

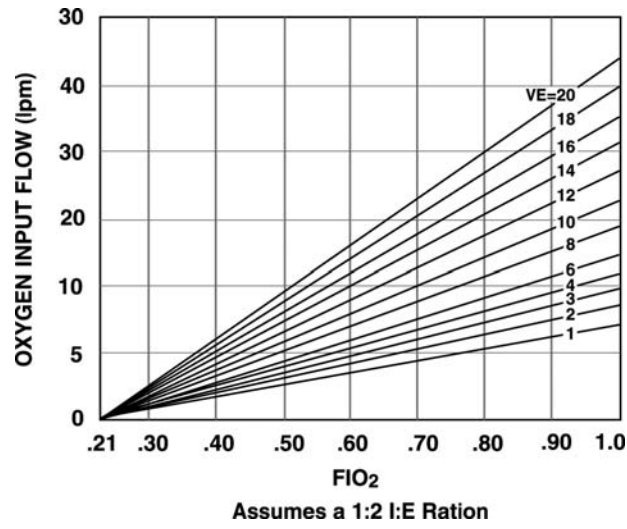

P/N 10674, Rev. H

LTV<sup>®</sup> Series Ventilators

65

### Oxygen Computer Chart

#### To determine O<sub>2</sub> Input Flow:

- 1) Find the desired FIO<sub>2</sub> on the horizontal axis.
- 2) Project up to the minute volume.
- 3) Project horizontally to the left vertical axis and read the oxygen flow.

#### To determine O<sub>2</sub> Concentration:

- 1) Find the O<sub>2</sub> input flow on the vertical axis.
- 2) Project horizontally right to the minute volume.
- 3) Project vertically down to the horizontal axis and read the FIO<sub>2</sub>.

P/N 10674, Rev. H

LTV<sup>®</sup> Series Ventilators

66

## ALARMS

### How to Silence and Reset Alarms

To silence an alarm, press the **Silence Reset** button.

To reset an alarm that has been corrected, press the **Silence Reset** button again.



Alarm	Cause	Solution
<b>APNEA XX bpm</b>	Occurs when the time since the last breath start exceeds the set Apnea Interval. When an Apnea alarm occurs, the ventilator will enter Apnea Back up ventilation mode.	Reevaluate the patient's condition.  Reevaluate ventilator settings.
<b>APNEA</b>	An Apnea alarm has occurred and cleared. The ventilator is no longer in Apnea Back-up mode.	Reevaluate the patient's condition.  Reevaluate ventilator settings.

Alarm	Cause	Solution
<b>BAT EMPTY</b>	Occurs when the ventilator is operating from the internal battery power and the batter charge level is critically low. This alarm can be temporarily silenced but cannot be cleared.	Attach the ventilator to external AC or DC power.
<b>BATTERY LOW</b>	Occurs when the ventilator is operating from internal battery power and the battery charge level is low.	Attach the ventilator to external AC or DC power. Reevaluate power requirements.
<b>DEFAULTS</b>	Occurs during POST when the ventilator detects an invalid setting stored in non-volatile memory.	Push the <b>Silence/Reset</b> button twice to reset alarm. Reevaluate ventilator settings.
<b>DEFAULTS SET</b>	Occurs when the ventilator is first powered up after the <b>SET DEFAULTS</b> option has been used to reset all controls and extended features settings to their factory-set default values.	Push the <b>Silence/Reset</b> button twice to reset alarm. Reevaluate ventilator settings.

## Alarms

Alarm	Cause	Solution
<b>DISC/SENSE</b>	Occurs when the ventilator detects one of the following conditions: <ul style="list-style-type: none"> <li>The patient circuit or proximal pressure sense line has become disconnected.</li> <li>The low side exhalation flow transducer sense line has become disconnected.</li> <li>The proximal pressure sense line is pinched or occluded.</li> </ul>	Check Patient Circuit assembly for disconnects. Check pressure sensing lines for occlusions.
<b>HIGH O<sub>2</sub> PRES</b>	Occurs when the average oxygen inlet pressure exceeds the acceptable limit for the type of oxygen source.	Reduce O <sub>2</sub> inlet pressure.

Alarm	Cause	Solution
<b>HIGH PEEP<sup>3</sup></b>	Occurs when the ventilator detects one of the following conditions: <ul style="list-style-type: none"> <li>The patient circuit positive end expiratory pressure (PEEP) exceeds the High PEEP alarm setting.</li> <li>Patient Circuit, Exhalation valve and/or PEEP valve occluded.</li> </ul>	Reevaluate ventilator settings. Disassemble, clean and reassemble the Patient Circuit, Exhalation Valve and PEEP Valve.
<b>HIGH PRES</b>	Occurs when the circuit pressure exceeds the set High Pressure Limit setting.	Reevaluate ventilator settings. Inspect Patient Circuit for occlusions or kinks. Reevaluate patient.
<b>HW Fault</b>	Occurs when the ventilator detects a problem with the ventilator hardware.	If alarm reoccurs, contact your Service Rep or Pulmonetic Systems.

<sup>3</sup> The **HIGH PEEP** alarm is only available on ventilators with software version 3.15 or higher installed.

## Alarms

Alarm	Cause	Solution
<b>INOP</b> Vent Inop 	A ventilator INOP occurs when: <ul style="list-style-type: none"> <li>The ventilator is switched from On to Standby.</li> <li>The ventilator detects any condition that is deemed to make the ventilator unsafe.</li> </ul>	If an INOP alarm occurs during operation, remove ventilator from service and contact your Service Rep.
<b>LOCKED</b>	The <b>LOCKED</b> message is displayed when a button is pressed while the controls are locked. No audible alarm is given.	Press the <b>Control Lock</b> button.  If locked alert continues, press and hold the <b>Control Lock</b> button for three seconds.
<b>LOW MIN VOL</b>	Occurs when the exhaled minute volume is less than the set Low Minute Volume.	Examine Exhalation Valve body for disconnects.  Reevaluate patient.

Alarm	Cause	Solution
<b>LOW O<sub>2</sub> PRES</b>	Occurs when the average oxygen inlet pressure is less than the minimum acceptable inlet pressure of 35 PSIG.	Increase O <sub>2</sub> inlet pressure. If using O <sub>2</sub> cylinder, replace used cylinder with a new one.
<b>LOW PRES</b>	Occurs when the peak inspiratory pressure for a machine or assist breath is less than the Low Pressure setting.	Examine Patient Circuit for disconnect. Reevaluate ventilator settings. Reevaluate patient.
<b>NO CAL DATA, NO CAL</b>	Occurs when the ventilator detects invalid or missing calibration records on power up.	Remove ventilator from service, perform Calibration procedure.
<b>POWER LOST</b>	Occurs when the ventilator is operating on external power and the voltage drops below the useable level and switches to internal battery operation.	Evaluate power requirements. Attach ventilator to an external AC or DC power source.

## Alarms

Alarm	Cause	Solution
<b>POWER LOW</b>	Occurs when the ventilator is operating on external power and the voltage drops to the low level.	Evaluate power requirements.
<b>REMOVE PTNT</b>	Occurs when the ventilator is powered up in the Ventilator Checkout or Ventilator Maintenance modes. The ventilator is not delivering gas.	Ensure patient is disconnected from ventilator and is being ventilated by alternative means.
<b>RESET</b>	A <b>RESET</b> alarm occurs if the ventilator restarts following a condition other than being shut down by pressing the On/Standby button.	May be caused by Internal Battery depletion during operation <sup>4</sup> or ESD. If the problem reoccurs, remove from service and contact your Service Rep or Pulmonetic Systems

<sup>4</sup> Only available on ventilators with software version 3.13 or higher installed.

Alarm	Cause	Solution
<b>XDCR FAULT</b>	Occurs when a transducer autozero test fails.	Press <b>Silence/Reset</b> button twice to reset alarm. If problem occurs frequently, remove from service and contact your Service Rep. or Pulmonetic Systems.



Pulmonetic Systems®  
17400 Medina Rd., Suite 100  
Minneapolis, Minnesota 55447-1341

Tel: (763) 398-8500  
(800) 754-1914  
Fax: (763) 398-8400

[www.Pulmonetic.com](http://www.Pulmonetic.com)

# Appendix C

## Quick Reference Guide for LTV® 1200/1150 Series Ventilators

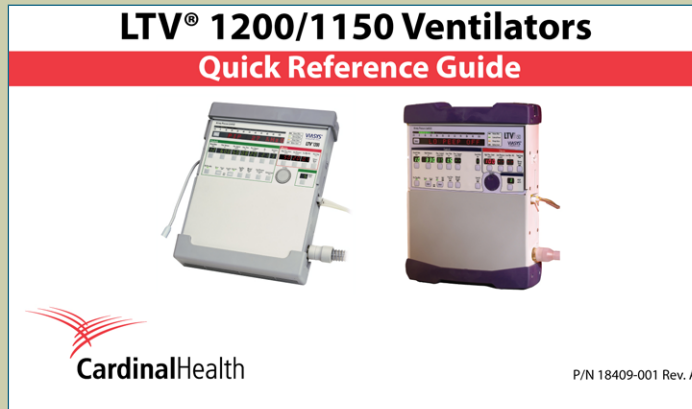





# LTV<sup>®</sup> 1200/1150 Ventilators

## Quick Reference Guide



P/N 18409-001 Rev. A

## ASSISTANCE

---

**Cardinal Health**  
**Pulmonetic Systems**  
17400 Medina Rd., Suite 100  
Minneapolis, Minnesota 55447-1341

Customer Care: (800) 754-1914  
(763) 398-8500  
Fax: (763) 398-8403  
Website: [www.cardinalhealth.com/viasys](http://www.cardinalhealth.com/viasys)

# TABLE OF CONTENTS

---

## Table of Contents:

<b>Front and Side Panel Reference .....</b>	<b>1</b>
Front Panel Display and Description.....	1
Side Panel Descriptions.....	3
<b>Turning the Ventilator On and Off .....</b>	<b>5</b>
Turning the Ventilator On .....	5
Turning the Ventilator Off .....	6
<b>Variable Controls.....</b>	<b>7</b>
<b>SETTING UP MODES OF VENTILATION.....</b>	<b>9</b>
Setting Up Assist/Control Mode.....	9
Setting Up SIMV Mode.....	11
Setting Up CPAP Mode.....	13
Setting Up NPPV Mode.....	15
<b>Monitored Data .....</b>	<b>17</b>
<b>Extended Features .....</b>	<b>19</b>
SBT (Spontaneous Breathing Trial).....	21

P/N 18409-001, Rev. A

LTV® 1200/1150 Ventilator

iii

<b>Using AC/DC Power .....</b>	<b>25</b>
Using the AC Adapter.....	25
Using an External DC Power Source.....	26
<b>Power Displays and Indicators .....</b>	<b>27</b>
<b>Attaching a Breathing Circuit.....</b>	<b>30</b>
<b>Oxygen Computer Chart.....</b>	<b>31</b>
<b>Alarms .....</b>	<b>33</b>

P/N 18409-001, Rev. A

LTV® 1200/1150 Ventilator

iv

## FRONT AND SIDE PANEL REFERENCE

### Front Panel Display and Description (LTV<sup>®</sup> 1200 shown)

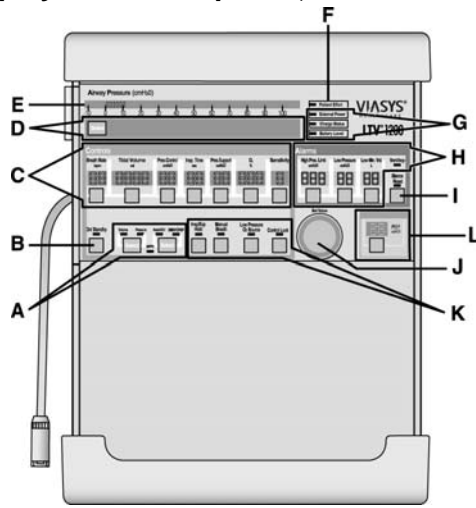

P/N 18409-001, Rev. A

LTV<sup>®</sup> 1200/1150 Ventilator

1

- A - **Mode and Breath Selection** – Selects ventilation modes, and selects breath types.
- B - **On/Standby Button** – Turns the ventilator “On” or to “Standby”.
- C - **Variable Control Settings** – Sets and displays each ventilation characteristic.
- D - **Display Window** – Displays Alarm Messages, Monitored Data, and Extended Features menus.
- E - **Airway Pressure Display** – Displays real-time airway circuit pressure.
- F - **Patient Effort Indicator** – LED is lit briefly each time a patient trigger is detected.
- G - **Power Source** – Displays power source and charge levels.
- H - **Variable Alarm Settings** – Sets and displays variable alarm levels.
- I - **Alarm Silence/Reset** – Silences audible alarms. Clears visual alarms.
- J - **Set Value Knob** – Changes variable control settings. Navigates Extended Features.
- K - **Special Controls** – Activates special controls such as Manual Breath, Low Pressure O<sub>2</sub> Source (LTV<sup>®</sup> 1200 only), Insp/Exp Hold and Control Lock feature.
- L - **PEEP** – PEEP control setting and display.

P/N 18409-001, Rev. A

LTV<sup>®</sup> 1200/1150 Ventilator

2

## FRONT AND SIDE PANEL REFERENCE

### Side Panel Descriptions

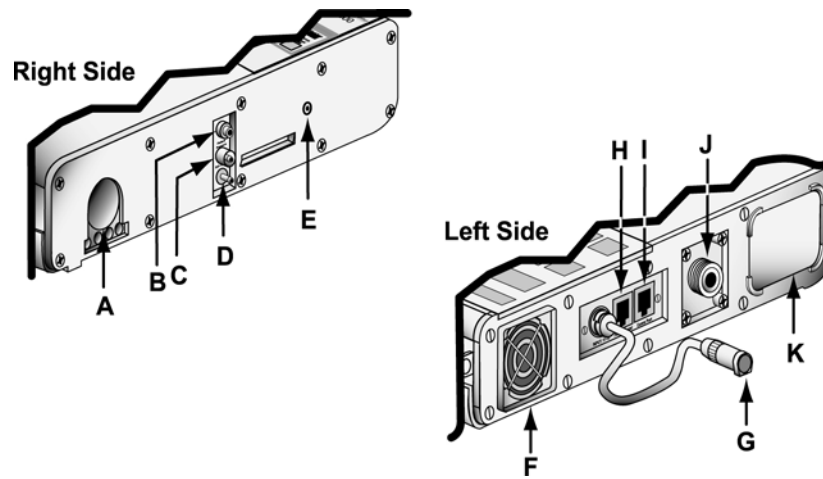

P/N 18409-001, Rev. A

LTV® 1200/1150 Ventilator

3

- A - **22mm Outlet Port** – Patient Breathing Circuit outlet port.
- B - **Flow Xducer** – Flow Transducer high pressure sensing port.
- C - **Flow Xducer** – Flow Transducer low pressure sensing port.
- D - **Exh Valve** – Exhalation Valve drive line port.
- E - **Alarm Sounder Port**
- F - **Cooling Fan**
- G - **DC Input** – DC power port pigtail connector.
- H - **Patient Assist** – Patient Assist Call jack.
- I - **Comm Port** – Communications port.
- J - **O<sub>2</sub> Inlet** – Oxygen Inlet fitting.
- K - **Filter** – Air Inlet.

P/N 18409-001, Rev. A

LTV® 1200/1150 Ventilator

4

## TURNING THE VENTILATOR ON AND OFF

### Turning the Ventilator On



1) Push the **On/Standby** button.

If the Patient Query feature is enabled/on when the ventilator is powered up, ventilation and alarm activation are suspended and the message **SAME PATIENT** is displayed.

- To enable the suspended alarms and begin ventilation with the settings in use during the last power cycle, press the **Select** button while **SAME PATIENT** is displayed.
- To enable the suspended alarms and begin ventilation with Preset values appropriate for a new patient, turn the **Set Value** knob until **NEW PATIENT** is displayed and press the **Select** button. Then turn the **Set Value** knob until the desired patient type is displayed (**INFANT**, **PEDIATRIC** or **ADULT**) and press the **Select** button (see the *LTV<sup>®</sup> 1200 or LTV<sup>®</sup> 1150 Operator's Manual*, Chapter 10, for detailed settings and information).

If the Patient Query feature is disabled/off when the ventilator is powered up and passes POST, it will begin ventilation (appropriate alarms enabled) using the settings in use during the last power cycle.

### Turning the Ventilator Off

**To turn the ventilator off:**

1) **Disconnect the patient from the ventilator.**

2) Press and hold the **On/Standby** button for 3 seconds. The ventilator ceases operating, the audible alarm sounds continuously and the **Vent Inop** LED is lit.



3) Press the **Silence/Reset** button to silence the audible alarm.

- Verify a confirming audible chirp is activated immediately after the alarm is silenced.





4) The ventilator continues to charge the internal battery as long as it is connected to an external power source.

**Note:** The **Vent Inop** LED will remain lit for a minimum of 5 minutes and does not impact battery life.

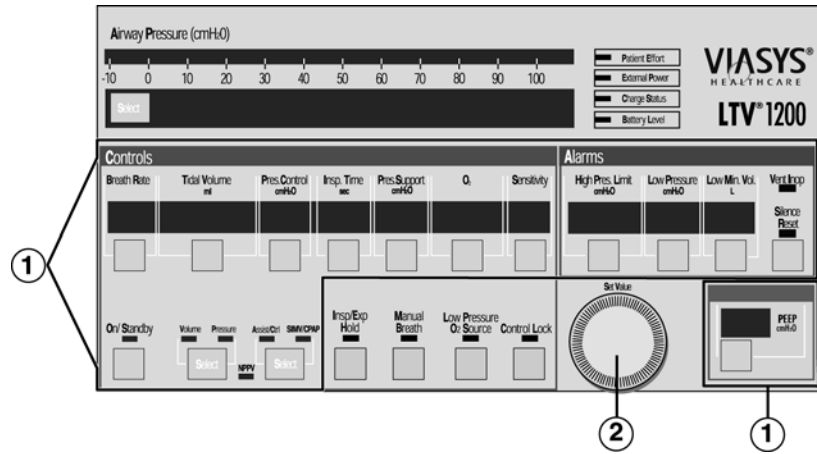
## VARIABLE CONTROLS



### To set a variable control:

- 1) Select the control by pressing the associated button. The display for the selected control will be displayed at normal brightness and all other control displays will be dimmed.
- 2) Change the control value by rotating the **Set Value** Knob. Rotate clockwise to increase and counter-clockwise to decrease the value. 
- 3) The new control value goes into effect when the operator:
  - Presses the selected button again, or
  - Selects another control, or
  - Presses the **Control Lock** button, or 
  - Waits 5 seconds

All controls will then return to their normal brightness.

## SETTING UP MODES OF VENTILATION

### Setting Up Assist/Control Mode

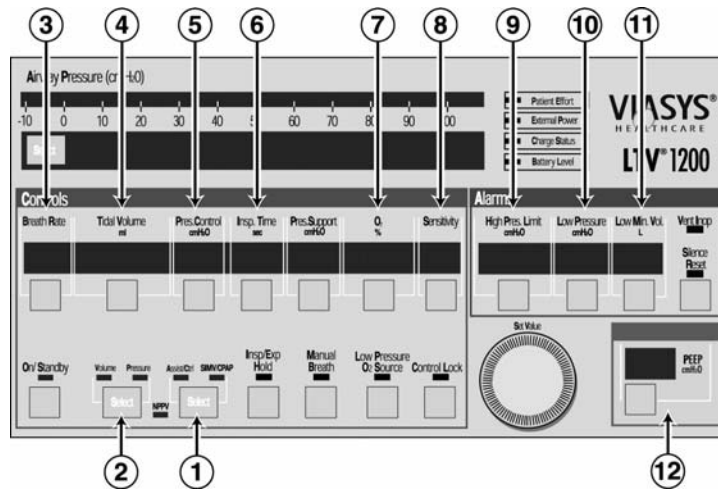

#### Setting Up the Ventilator in Assist/Control Mode:

- 1) Press the **Select** button twice to toggle the modes between **Assist/Control** and **SIMV/CPAP**. Select the **Assist/Control** mode.
- 2) Press the **Select** button twice to toggle between **Volume** and **Pressure** ventilation. Select **Volume** or **Pressure**, as desired.
- 3) Set the **Breath Rate**.
- 4) If **Volume** ventilation is selected, set the **Tidal Volume**. The calculated peak flow **Vcalc** is displayed in the window while Tidal Volume is being changed.
- 5) If **Pressure** ventilation is selected, set the **Pressure Control**.
- 6) Set the **Inspiratory Time**. The calculated peak flow **Vcalc** is displayed in the window while Inspiratory Time is being changed. **Vcalc** only applies to volume ventilation.
- 7) Set **O<sub>2</sub>%** (LTV<sup>®</sup> 1200 only).
- 8) Set the **Sensitivity** to a setting from 1 to 9.
- 9) Set the **High Pres. Limit** alarm.
- 10) Set the **Low Pressure** alarm.
- 11) Set the **Low Min. Vol.** alarm.
- 12) Adjust the **PEEP** control.



## SETTING UP MODES OF VENTILATION

### Setting Up SIMV Mode

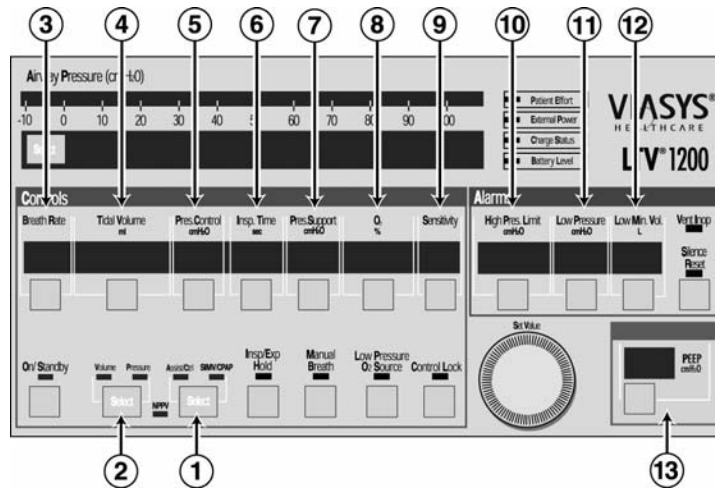

#### To set the Ventilator up in SIMV mode:

- 1) Press the **Select** button twice to toggle the modes between **Assist/Control** and **SIMV/CPAP**. Select the **SIMV/CPAP** mode.
- 2) Press the **Select** button to toggle between **Volume** and **Pressure** ventilation. Select **Volume** or **Pressure**, as desired.
- 3) Set the **Breath Rate**.
- 4) If **Volume** ventilation is selected, set the **Tidal Volume**. The calculated peak flow **Vcalc** is displayed in the window while Tidal Volume is being changed.
- 5) If **Pressure** ventilation is selected, set the **Pressure Control**.
- 6) Set the **Inspiratory Time**. The calculated peak flow **Vcalc** is displayed in the window while Inspiratory Time is being changed. **Vcalc** only applies to volume ventilation.
- 7) Set the **Pressure Support**, if desired.
- 8) Set **O<sub>2</sub>%** (LTV<sup>®</sup> 1200 only).
- 9) Set the **Sensitivity** to a setting from 1 to 9.
- 10) Set the **High Pres. Limit** alarm.
- 11) Set the **Low Pressure** alarm.
- 12) Set the **Low Min. Vol.** alarm.
- 13) Adjust the **PEEP** control.

## SETTING UP MODES OF VENTILATION

### Setting Up CPAP Mode

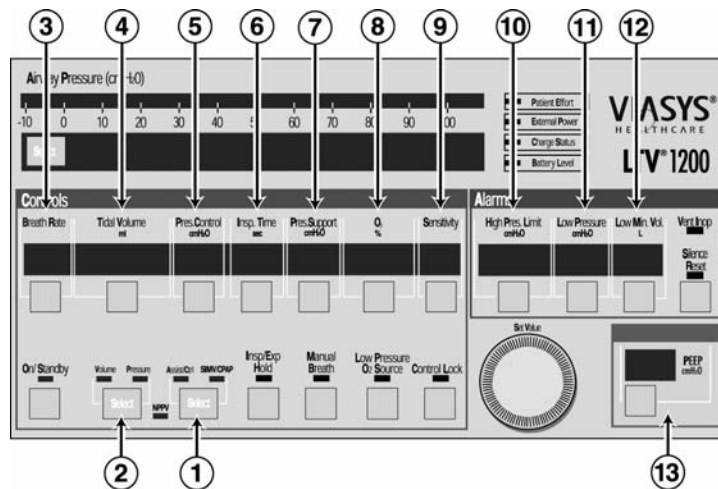

#### To set the ventilator up in CPAP mode:

- 1) Press the **Select** button twice to toggle the modes between **Assist/Control** and **SIMV/CPAP**. Select the **SIMV/CPAP** mode.
- 2) Press the **Select** button twice to toggle between **Volume** and **Pressure** ventilation for Apnea backup. Select **Volume** or **Pressure** for Apnea backup.
- 3) Set the **Breath Rate** to Off (dashes "- -").
- 4) If **Volume** ventilation is selected, set the **Tidal Volume** for Apnea backup. The calculated peak flow **Vcalc** is displayed in the window while Tidal Volume is being changed.
- 5) If **Pressure** ventilation is selected, set the **Pressure Control** for Apnea backup.
- 6) Set the **Inspiratory Time** for Apnea backup. The calculated peak flow **Vcalc** is displayed in the window while Inspiratory Time is being changed. **Vcalc** only applies to volume ventilation.
- 7) Set the **Pressure Support**, if desired.
- 8) Set **O<sub>2</sub>%** (LTV<sup>®</sup> 1200 only).
- 9) Set the **Sensitivity** to a setting from 1 to 9.
- 10) Set the **High Pres. Limit** alarm.
- 11) Set the **Low Pressure** alarm for Apnea backup.
- 12) Set the **Low Min. Vol.** alarm.
- 13) Adjust the **PEEP** control.

## SETTING UP MODES OF VENTILATION

### Setting Up NPPV Mode

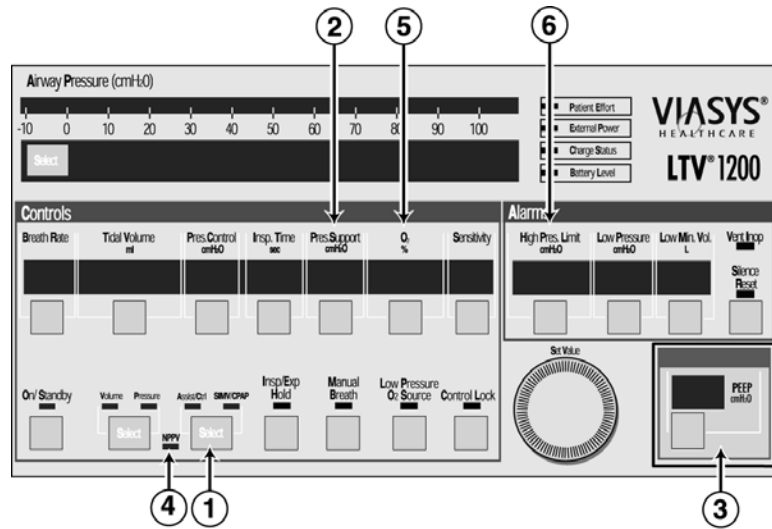

P/N 18409-001, Rev. A

LTV<sup>®</sup> 1200/1150 Ventilator

15

#### To set the Ventilator up in NPPV mode:

##### Set any desired Extended Features options and:

- 1) Push the **Assist/Control, SIMV/CPAP** mode button until the **NPPV** LED flashes. Press the button once more to confirm. The **NPPV** LED continues to flash and **SET IPAP** displays. The **Pres. Support** control display is bright and all other controls dim.
- 2) Turn the **Set Value** knob to adjust the IPAP value (shown in **Pres. Support** LED window). Press the **Pres. Support** button to confirm, **SET EPAP** will display. The **PEEP** control display is bright and all other controls are dim.
- 3) Turn the **Set Value** knob to adjust the EPAP value (shown in the **PEEP** LED window). Press the **PEEP** button to confirm.
- 4) The **PEEP** button push confirms **NPPV** operation and LED then turns solid.
- 5) Set **O<sub>2</sub>%** (LTV<sup>®</sup> 1200 only).
- 6) Set the **High Pres. Limit** alarm.

P/N 18409-001, Rev. A

LTV<sup>®</sup> 1200/1150 Ventilator

16

## MONITORED DATA

The monitored data displays may be automatically scrolled or manually scrolled. To cycle through the available monitored data automatically from a halted scan, press the Monitor **Select** button (left of display window) twice. Pressing the **Select** button once while scan is active shall halt scanning and the currently display monitor shall remain in the display window. Each time you press the button once; the next data item in the list will be displayed. To resume scan, press the **Select** button twice within 0.3 seconds. The monitored data is displayed in the following order:

Display	Description
<b>PIP</b>	Displays the Peak Inspiratory Pressure measured during the inspiratory phase. PIP is not updated for spontaneous breaths.
<b>MAP</b>	Displays a running average of the airway pressure for the last 60 seconds.
<b>PEEP</b>	Displays the pressure in the airway circuit at the end of exhalation.
<b>f</b>	Displays the breaths per minute and includes all breath types.
<b>Vte</b>	Displays the exhaled tidal volume as measured at the patient wye.
<b>VE</b>	Displays the exhaled tidal volume for the last 60 seconds as calculated from the last 8 breaths.

Display	Description
<b>I:E</b>	Displays the ratio between measured inspiratory time and measured exhalation time. Both normal and inverse I:E Ratios are displayed.
<b>I:Ecalc</b>	Displays the ratio between the set Breath Rate and Inspiratory Time. The display is updated in real-time while the Breath Rate setting is being changed.
<b>Vcalc</b>	Is based on the Tidal Volume and Inspiratory Time settings. Displayed when selected and whenever Tidal Volume or Inspiratory Time is selected for change.
<b>SBT min</b>	Displays the time remaining until the number of minutes preset in the SBT OP, MINUTES menu have elapsed. (Only displayed in the SBT mode of ventilation.)
<b>f/Vt f</b>	f/Vt is computed every time the Total Breath Rate (f) or Total Minute Volume (VE) is calculated. (Only displayed when SBT mode is selected.)

## EXTENDED FEATURES

### Navigating the Extended Features Menus:

To enter the **Extended Features menu** (in normal ventilation mode), press and hold the Monitor **Select** button for three seconds.



To view the next item in a menu, turn the **Set Value** knob clockwise.



To view the previous item, turn the **Set Value** knob counterclockwise.



To enter a menu item or select a setting, press the **Select** button.



To exit a menu, turn the **Set Value** knob until the **EXIT** option is displayed, then press the **Select** button or press **Control Lock**.

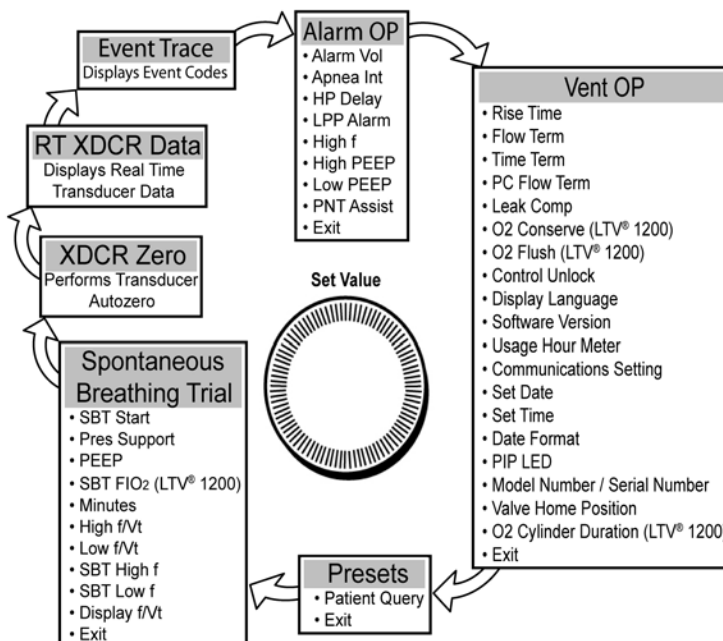

## ***EXTENDED FEATURES***

---

### **SBT (Spontaneous Breathing Trial)**

Using the Spontaneous Breathing Trial option you can temporarily minimize ventilatory support and perform clinical assessments of a patient's dependence on, or ability to be removed from positive pressure ventilation. SBT mode should be used only while attended by a Respiratory Therapist or other properly trained and qualified personnel (please refer to the *LTV<sup>®</sup> 1200 or LTV<sup>®</sup> 1150 Operator's Manual*, Chapter 10, for more information).

**When the Spontaneous Breathing Trial mode is turned on (SBT ON selected);**

- The ventilator switches to CPAP mode.
- Pressure Support and FiO<sub>2</sub> control settings on the front panel are overridden with the values preset in the SBT OP menus.
- The High Breath Rate alarm (**HIGH f**) in the **ALARM OP** menu is disabled (as long as the SBT mode is on).

## ***EXTENDED FEATURES***

---

### **SBT (Spontaneous Breathing Trial)**

**To modify the Spontaneous Breathing Trial settings:**



- 1) Turn the **Set Value** knob until **SBT START** is displayed, push the **Select** button, and **SBT OFF** or **SBT ON** is displayed.

Turn the **Set Value** knob until the desired setting is displayed, and push the **Select** button.



- When **SBT ON** is selected, the Spontaneous Breathing Trial ventilation mode is turned on using the current SBT menu settings. If the SBT menu settings were not previously reset, the factory set default settings will be used. **All SBT menu settings are to be reviewed for applicability and/or set as necessary, prior to selecting the SBT ON menu option.**
- When the Spontaneous Breathing Trial ventilation mode is active and **SBT OFF** is selected, the Spontaneous Breathing Trial ventilation mode is terminated and ventilation returns to the previously set modes/settings.

## SBT (Spontaneous Breathing Trial)

### 2) SBT Menu Options

#### SBT OP

SBT START  
PRES SUPPORT  
PEEP  
SBT FIO2 (LTV<sup>®</sup> 1200 only)  
MINUTES  
HIGH f/Vt  
LOW f/Vt  
SBT HIGH f  
SBT LOW f  
DISPLAY f/Vt  
EXIT

Turn the **Set Value** knob until desired SBT menu option is displayed, push the **Select** button and the value setting is displayed.

Turn the **Set Value** knob until the desired setting is displayed, push the **Select** button, and the desired value is set.

## EXTENDED FEATURES

---

### Exiting Extended Features

#### To return to Monitored Parameters:

- 1) Turn the **Set Value** knob until **EXIT** is displayed.



- 2) Press the **Select** button.



- 3) Repeat Steps 1 and 2 until the Monitored Parameters are displayed.

## USING AC/DC POWER

---

### Using the AC Adapter

To run the ventilator from an external AC power source.

- 1) Connect the power jack (straight or 90°) from the AC adapter to the power port pigtail connector on the left side of the ventilator.
- 2) Connect the proper AC power cable (110 or 220 V plug) to the AC power adapter.
- 3) Connect the 110 or 220 V power cable to a suitable power source.

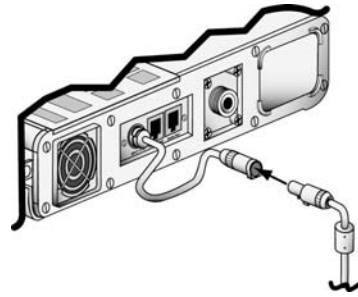

While the ventilator is plugged in, the internal battery is continuously charged.

**CAUTION: Release Button** – To avoid damaging the ventilator or the power connector, press the release button on the connector before removing it from the ventilator power port pigtail connector.

### Using an External DC Power Source

To run the ventilator from an external DC power source.

- 1) Connect the power port of the external DC power adapter cable to the power port pigtail connector on the left side of the ventilator.
- 2) If applicable, connect the DC jack to the DC power source.



## POWER DISPLAYS AND INDICATORS

---

### Indicators

**Battery Level** 

The Battery Level indicator shows the level of available internal battery power while running from the internal battery.

LED Color	Battery Level	Approximate Battery Time @ nominal settings
Green	Internal battery level is acceptable	45 minutes
Amber	Internal battery level is low	10 minutes
Red	Internal battery level is critically low	5 minutes
Off	Ventilator is running on AC or External Battery	

### Indicators

**Charge Status** 

When the ventilator is plugged into an External Power source, it automatically charges the internal battery.

LED Color	Charge Status
Flashing Amber	The ventilator is performing pre-charge qualification testing of the battery prior to starting the charge process. This happens when external power is first applied to the ventilator. The qualification process normally takes a few seconds but may take up to an hour on a deeply discharged battery.
Green	The internal battery is charged to full level.
Amber	The battery has not reached a full charge level and is still charging.
Red	The ventilator has detected a charge fault or internal battery fault. The internal battery cannot be charged. Contact a Pulmonetic Systems Certified Service Technician.

## POWER DISPLAYS AND INDICATORS

### Indicators

#### External Power



The External Power indicator shows the level of external power while the ventilator is operating from an external power source. When the ventilator is running from the internal battery, the External Power indicator is off. When running from external power, the indicator shows the following levels.

LED Color	Power Level
Green	External Power level is acceptable
Amber	External Power level is low

External power may be provided by connecting the ventilator to an external battery or to an external AC power source.

## ATTACHING A BREATHING CIRCUIT

### How to attach a Patient Breathing Circuit.

- 1) Connect the main breathing tube to the 22 mm outlet port on the right side of the ventilator.
- 2) Connect the two exhalation flow transducer sense lines to the ports marked **Flow Xducer** on the right side of the ventilator. These are non-interchangeable Luer fittings.
- 3) Connect the Exhalation Valve driver line to the port marked **Exh Valve** on the right side of the ventilator.

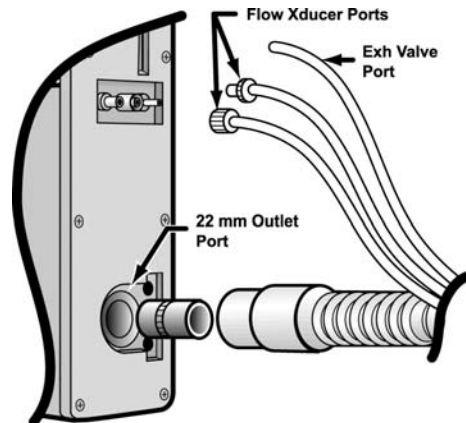

## OXYGEN COMPUTER CHART

---

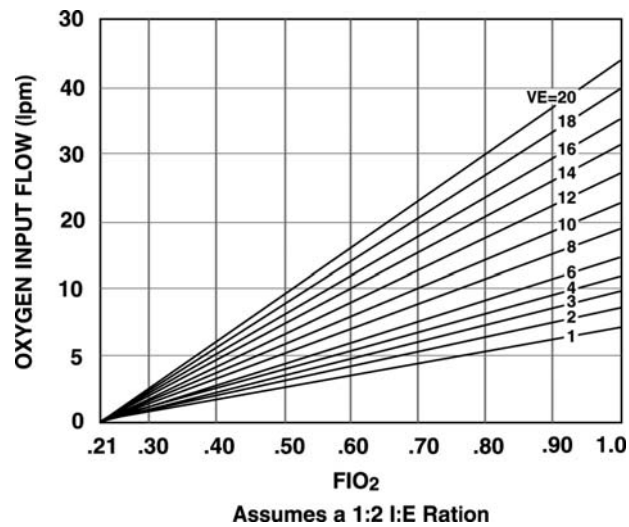

P/N 18409-001, Rev. A

LTV<sup>®</sup> 1200/1150 Ventilator

31

### Oxygen Computer Chart

#### To determine O<sub>2</sub> Input Flow:

- 1) Find the desired FIO<sub>2</sub> on the horizontal axis.
- 2) Project up to the minute volume.
- 3) Project horizontally to the left vertical axis and read the oxygen flow.

#### To determine O<sub>2</sub> Concentration:

- 1) Find the O<sub>2</sub> input flow on the vertical axis.
- 2) Project horizontally right to the minute volume.
- 3) Project vertically down to the horizontal axis and read the FIO<sub>2</sub>.

P/N 18409-001, Rev. A

LTV<sup>®</sup> 1200/1150 Ventilator

32

## ALARMS

### How to Silence and Reset Alarms

To silence an alarm, press the **Silence Reset** button.

To reset an alarm that has been corrected, press the **Silence Reset** button again.



Alarm	Cause	Solution
<b>APNEA XX bpm</b>	Occurs when the time since the last breath start exceeds the set Apnea Interval. When an Apnea alarm occurs, the ventilator will enter Apnea Back up ventilation mode.	Reevaluate the patient's condition.  Reevaluate ventilator settings.
<b>APNEA</b>	An Apnea alarm has occurred and cleared. The ventilator is no longer in Apnea Back-up mode.	Reevaluate the patient's condition.  Reevaluate ventilator settings.

Alarm	Cause	Solution
<b>BAT EMPTY</b>	Occurs when the ventilator is operating from the internal battery power and the batter charge level is critically low. This alarm can be temporarily silenced but cannot be cleared.	Attach the ventilator to external AC or DC power.
<b>BAT LOW</b>	Occurs when the ventilator is operating from internal battery power and the battery charge level is low.	Attach the ventilator to external AC or DC power. Reevaluate power requirements.
<b>DEFAULTS</b>	Occurs during POST when the ventilator detects an invalid setting stored in non-volatile memory.	Push the <b>Silence/Reset</b> button twice to reset alarm. Reevaluate ventilator settings.
<b>DEFAULTS SET</b>	Occurs when the ventilator is first powered up after the <b>SET DEFAULTS</b> option has been used to reset all controls and extended features settings to their factory-set default values.	Push the <b>Silence/Reset</b> button twice to reset alarm. Reevaluate ventilator settings.

## Alarms

Alarm	Cause	Solution
<b>DISC/SENSE</b>	Occurs when the ventilator detects one of the following conditions: <ul style="list-style-type: none"> <li>The patient circuit or proximal pressure sense line has become disconnected.</li> <li>The low side exhalation flow transducer sense line has become disconnected.</li> <li>The proximal pressure sense line is pinched or occluded.</li> </ul>	Check Patient Circuit assembly for disconnects. Check pressure sensing lines for occlusions.
<b>HIGH f</b>	Occurs when the Total Breath Rate (f) exceeds the high breath rate and time period alarm values.	Check Patient Circuit assembly for leaks. Check <b>HIGH f</b> alarm values.
<b>HIGH O<sub>2</sub> PRES</b> (LTV <sup>®</sup> 1200 only)	Occurs when the average oxygen inlet pressure exceeds the acceptable limit for the type of oxygen source.	Reduce O <sub>2</sub> inlet pressure.

Alarm	Cause	Solution
<b>HIGH PEEP</b>	Occurs when the ventilator detects one of the following conditions: <ul style="list-style-type: none"> <li>The patient circuit positive end expiratory pressure (PEEP) exceeds the High PEEP alarm setting.</li> <li>Patient Circuit, Exhalation valve and/or PEEP valve occluded.</li> </ul>	Reevaluate ventilator settings. Disassemble, clean and reassemble the Patient Circuit, Exhalation Valve and PEEP Valve.
<b>HIGH PRES</b>	Occurs when the circuit pressure exceeds the set High Pressure Limit setting.	Reevaluate ventilator settings. Inspect Patient Circuit for occlusions or kinks. Reevaluate patient.
<b>HW Fault</b>	Occurs when the ventilator detects a problem with the ventilator hardware.	If alarm reoccurs, contact your Service Rep or Pulmonetic Systems.

## Alarms

Alarm	Cause	Solution
<b>INOP</b> Vent Inop 	A ventilator INOP occurs when: <ul style="list-style-type: none"> <li>The ventilator is switched from On to Standby.</li> <li>The ventilator detects any condition that is deemed to make the ventilator unsafe.</li> </ul>	If an <b>INOP</b> alarm occurs during operation, remove ventilator from service and contact your Service Rep.
<b>LOCKED</b>	The <b>LOCKED</b> message is displayed when a button is pressed while the controls are locked. No audible alarm is given.	Press the <b>Control Lock</b> button.  If locked alert continues, press and hold the <b>Control Lock</b> button for three seconds.
<b>LOW MIN VOL</b>	Occurs when the exhaled minute volume is less than the set Low Minute Volume.	Examine Exhalation Valve body for disconnects.  Reevaluate patient.

Alarm	Cause	Solution
<b>LOW O<sub>2</sub> PRES</b> (LTV <sup>®</sup> 1200 only)	Occurs when the average oxygen inlet pressure is less than the minimum acceptable inlet pressure of 35 PSIG.	Increase O <sub>2</sub> inlet pressure. If using O <sub>2</sub> cylinder, replace used cylinder with a new one.
<b>LOW PEEP</b>	Occurs when the patient circuit Positive End Expiratory Pressure (PEEP) is less than the Low PEEP alarm setting.	Reevaluate ventilator settings. Disassemble, clean and reassemble the Patient Circuit, Exhalation Valve and PEEP Valve.
<b>LOW PRES</b>	Occurs when the peak inspiratory pressure for a machine or assist breath is less than the Low Pressure setting.	Examine Patient Circuit for disconnect. Reevaluate ventilator settings. Reevaluate patient.
<b>NO CAL DATA,            NO CAL</b>	Occurs when the ventilator detects invalid or missing calibration records on power up.	Remove ventilator from service, perform Calibration procedure.

## Alarms

Alarm	Cause	Solution
<b>POWER LOST</b>	Occurs when the ventilator is operating on external power and the voltage drops below the useable level and switches to internal battery operation.	Evaluate power requirements. Attach ventilator to an external AC or DC power source.
<b>POWER LOW</b>	Occurs when the ventilator is operating on external power and the voltage drops to the low level.	Evaluate power requirements.
<b>REMOVE PTNT</b>	Occurs when the ventilator is powered up in the Ventilator Checkout or Ventilator Maintenance modes. The ventilator is not delivering gas.	Ensure patient is disconnected from ventilator and is being ventilated by alternative means.

Alarm	Cause	Solution
<b>RESET</b>	A <b>RESET</b> alarm occurs if the ventilator restarts following a condition other than being shut down by pressing the On/Standby button.	May be caused by Internal Battery depletion or ESD. If the problem reoccurs, remove from service and contact your Service Rep or Pulmonetic Systems
<b>SBT &lt; f</b> <b>SBT &gt; f</b> <b>SBT &lt; f/Vt</b> <b>SBT &gt; f/Vt</b> <b>SBT OFF</b>	These alarms are only active in the Spontaneous Breathing Trial (SBT) mode of ventilation (see the <i>LTV® 1200 or LTV® 1150 Operator's Manual</i> , Chapter 9, for more information on each alarm setting).	
<b>XDCR FAULT</b>	Occurs when a transducer autozero test fails.	Press <b>Silence/Reset</b> button twice to reset alarm. If problem occurs frequently, remove from service and contact your Service Rep. or Pulmonetic Systems.

**Cardinal Health**  
**Pulmonetic Systems**  
17400 Medina Rd., Suite 100  
Minneapolis, Minnesota 55447-1341

Customer Care: (800) 754-1914  
(763) 398-8500  
Fax: (763) 398-8403

[www.cardinalhealth.com/viasys](http://www.cardinalhealth.com/viasys)







## On the CD

---

- ✓ Glossary of Terms
- ✓ Identification and Preparation Tool
- ✓ Preparation for ICU Discharge
- ✓ Preparation for Hospital Discharge
- ✓ Home Ventilation & Tracheostomy Care (for Adults)
- ✓ Non-Invasive Positive Pressure Ventilation (for Adults)
- ✓ Home Ventilation and Tracheostomy Care (for Paediatrics)
- ✓ Pulmonary Clearance Techniques
- ✓ Routine Tasks
- ✓ My Education Checklist and Learning Log
- ✓ Oximeter Teaching Checklist
- ✓ Troubleshooting Guide
- ✓ Emergency Contacts and Planning
- ✓ Useful Web Resources
- ✓ Emergency Preparedness Guide for People with Disabilities/Special Needs
- ✓ Assistive Devices Program Equipment/Supply Authorization Form
- ✓ Quick Reference Guide to LTV® 900, 950 & 1000 Series Ventilators
- ✓ Quick Reference Guide to LTV® 1200/1150 Series Ventilators

Resource CD

Partners



Funding provided by



College of  
Respiratory Therapists  
of Ontario

180 Dundas Street West, Suite 2103  
Toronto, Ontario M5G 1Z8  
Tel: 416-591-7800  
Fax: 416-591-7890  
Toll free: 1-800-261-0528  
Email: [questions@crto.on.ca](mailto:questions@crto.on.ca)  
Web site: [www.crto.on.ca](http://www.crto.on.ca)